

HD IP Video Door Phone Solution



HD IP Video Door Phone Solution

- AP-VAC70 HD IP Video Door Phone
- AP-VAC250 HD IP Video Door Phone
- AP-ACS1000 Door Access Control Server
- AP-VP280 IP Videp Phone

[Learn More >](#)

The image displays four AddPac products: a handheld IP video phone (AP-VP280) on the left, a rack-mountable door access control server (AP-ACS1000) in the center, and two wall-mounted IP video door phones (AP-VAC70 and AP-VAC250) on the right. The background is a dark blue gradient.

AddPac

AddPac Technology

2013, Sales and Marketing

www.addpac.com

Contents

- HD IP Video Door Phone Service Diagram
- HD IP Video Door Phone Comparison Table
- HD IP Video Door Phone
 - AP-VAC250
 - AP-VAC70
- Backend Solution
 - AP-VP280, AP-VP120 Video Phone
 - AP-ACS1000 Door Access Control Server & Web based Video Access Control Client(User registration, etc)
 - AP-SMP100 IP Soft Video Phone for Desktop, Notebook

Legacy PBX Environment

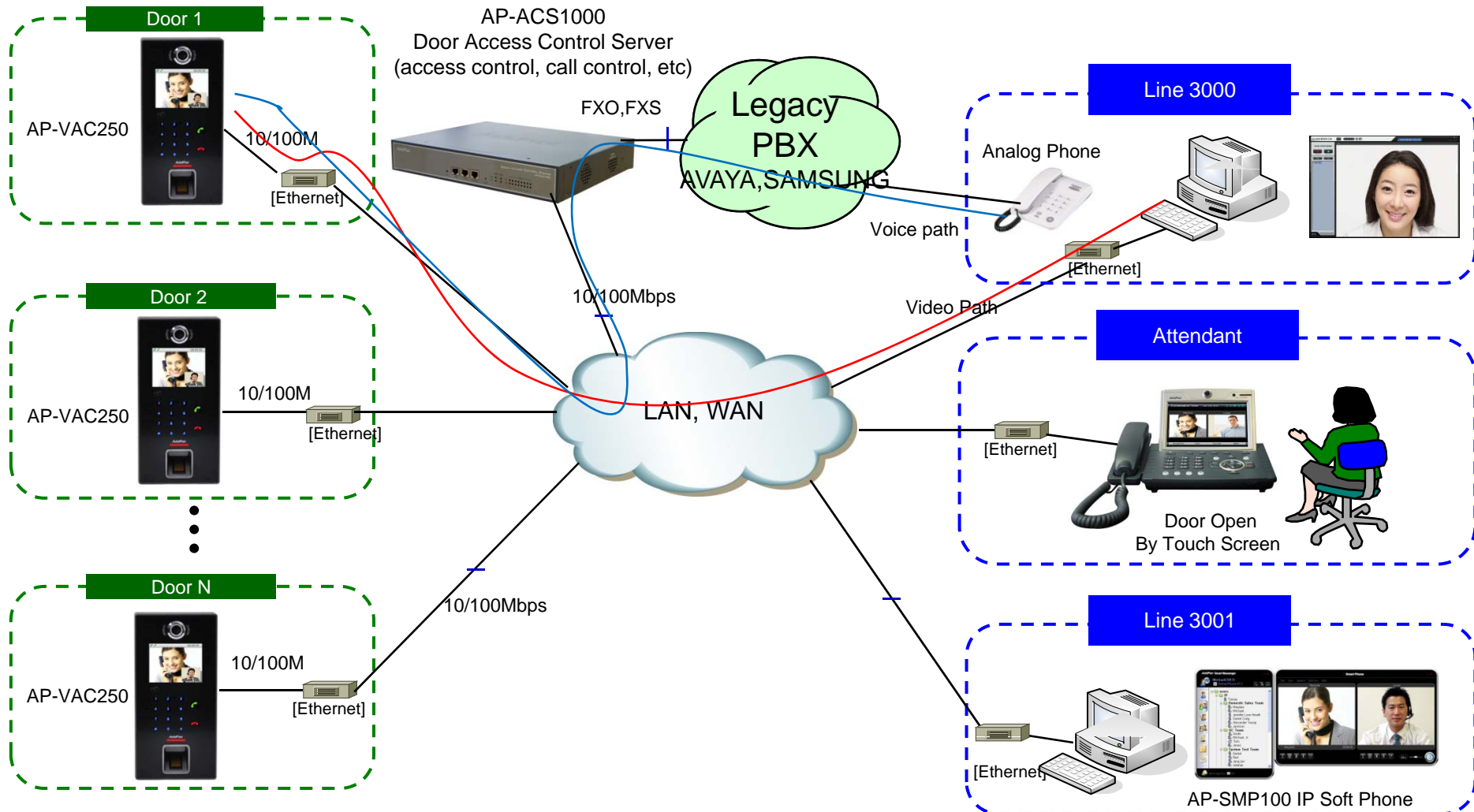

IP-PBX Environment

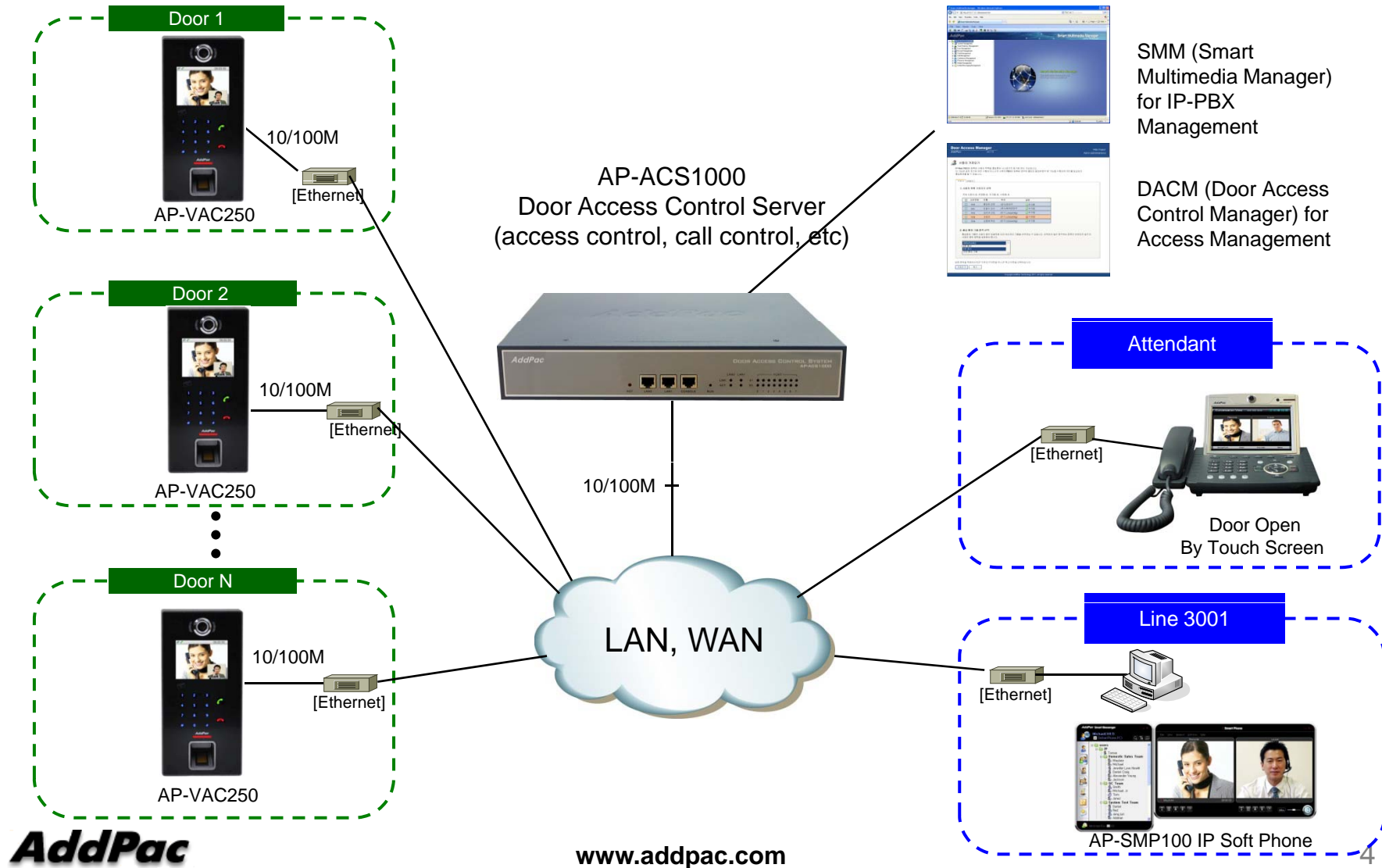



AP-ACS1000 Door Access Control Server

Contents

- DACS(Door Access Control Server) Network Diagram
- AP-ACS1000 DACS Main Features
- AP-ACS1000 DACS Hardware Specification
- DACS System Message Flow (Examples)
- DACM (Door Access Control Manager)
- Open API for Third Party Controller

Integrated Door Access Control and Call Control

AP-ACS1000 DACS (Door Access Control Server)

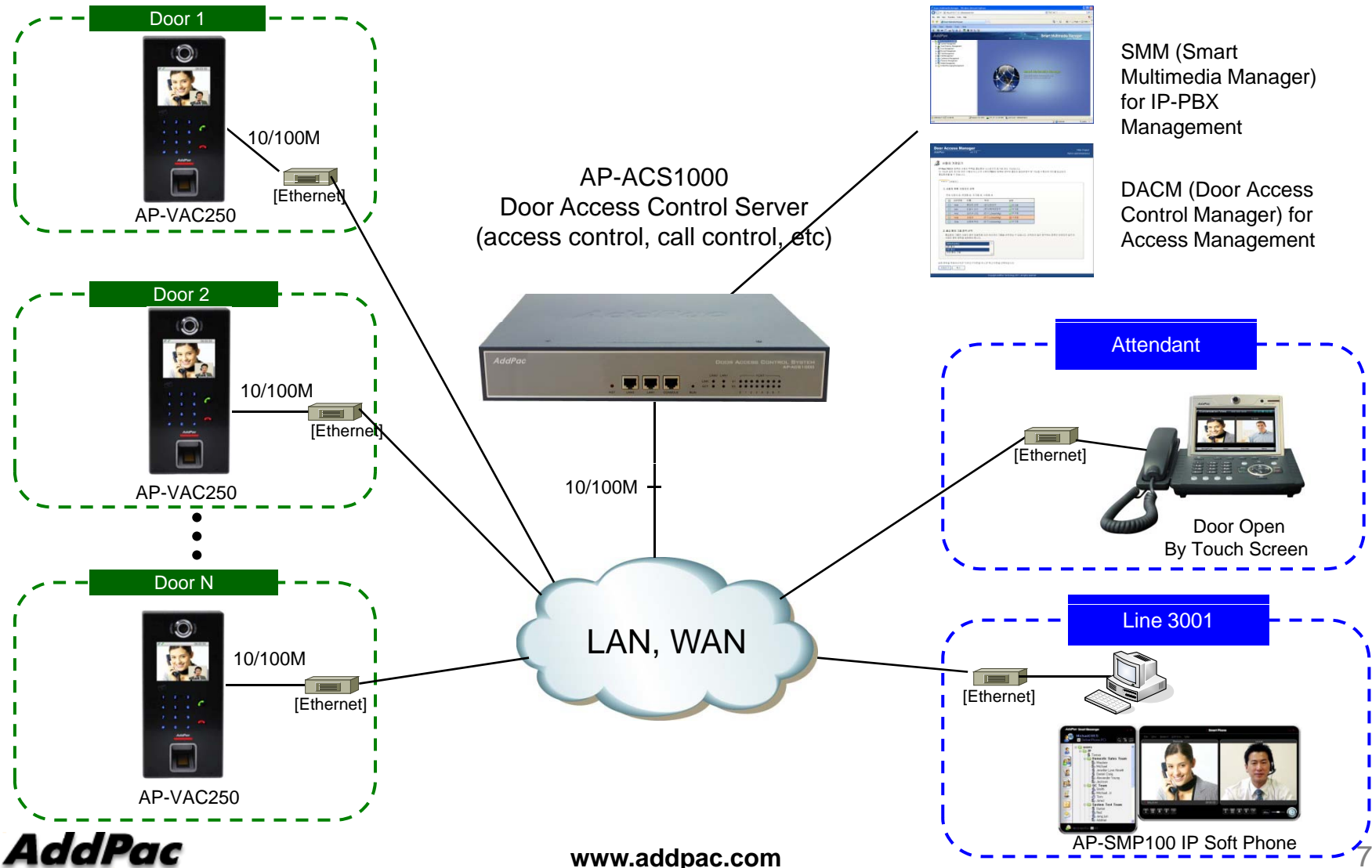

Main Features

AP-ACS1000 DACS (Door Access Control Server)

- Door Access Control Application System
- SIP Application Server, Proxy, Registrar and Location Server
- Multiple ITSP Trunk with SIP & H.323 Accounts Support
- Legacy PBX Interworking Service
- High Performance RISC & Programmable DSP Architecture
- Two(2) 10/100Mbps Fast Ethernet (IP Share ,etc)
- High Performance LAN-to-LAN Routing Capability
- Powerful Network Protocols (PPPoE, DHCP, Static Routing, etc)
- IPv4/IPv6 Dual Stack
- Firmware Upgradeable Architecture
- Smart Multimedia Manager for IP-PBX Management
- DACM(Door Access Control Manager)
- Advanced Voice QoS Mechanism
- Small, Light and Compact Design
- Two(2) VoIP Module Slots for Analog, Digital Interface

Hardware Specification

AP-ACS1000 DACS (Door Access Control Server)

- RISC Microprocessor Computing Power
- Main Chassis
 - Network Interface
 - Two(2) 10/100Mbps Fast Ethernet
 - One(1) RS-232C Console (RJ45)
 - Two(2) VoIP Module Slots for FXS, FXO etc



Hardware Specification

AP-ACS1000 DACS (Door Access Control Server)

AP-ACS1000 Front Side



LAN1 (10/100Mbps)

LAN0(10/100Mbps)

Console Port

www.addpac.com

Hardware Specification

AP-ACS1000 DACS (Door Access Control Server)

AP-ACS1000 Back Side



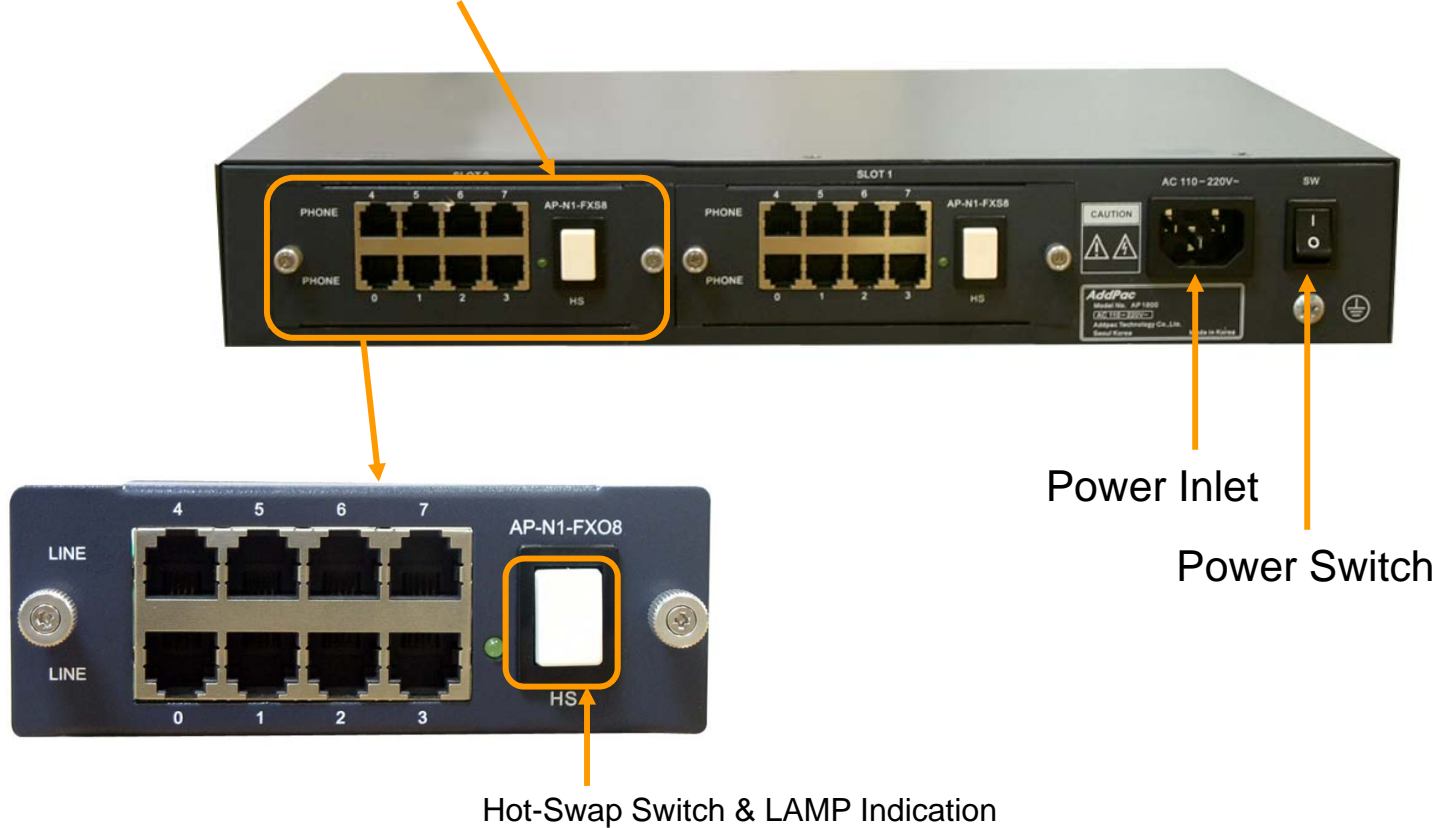

PSTN Interface Module



Hardware Specification

AP-ACS1000 DACS (Door Access Control Server)

PSTN Interface Module

AP-N1-FXS8	 A black 8-port FXS voice processing module with RJ11 ports numbered 0-7 and a central switch labeled 'HS'.	8-Port FXS Voice Processing Module (8 x RJ11)
AP-N1-FXO8	 A black 8-port FXO voice processing module with RJ11 ports numbered 0-7 and a central switch labeled 'HS'.	8-Port FXO Voice Processing Module (8 x RJ11)
AP-N1-FXO4S4	 A black 8-port voice processing module with RJ11 ports numbered 0-7 and a central switch labeled 'HS'.	4-Port FXO and 4-Port FXS Voice Processing Module (8 x RJ11)
AP-N1-E1T1	 A black 1-port VoIP digital E1/T1 interface module with an RJ45 port and a central switch labeled 'HS'.	1-Port VoIP Digital E1/T1 Interface Module(1xRJ45)



DACS System Message Flow

DACS System Message Flow

Registration and KeepAlive

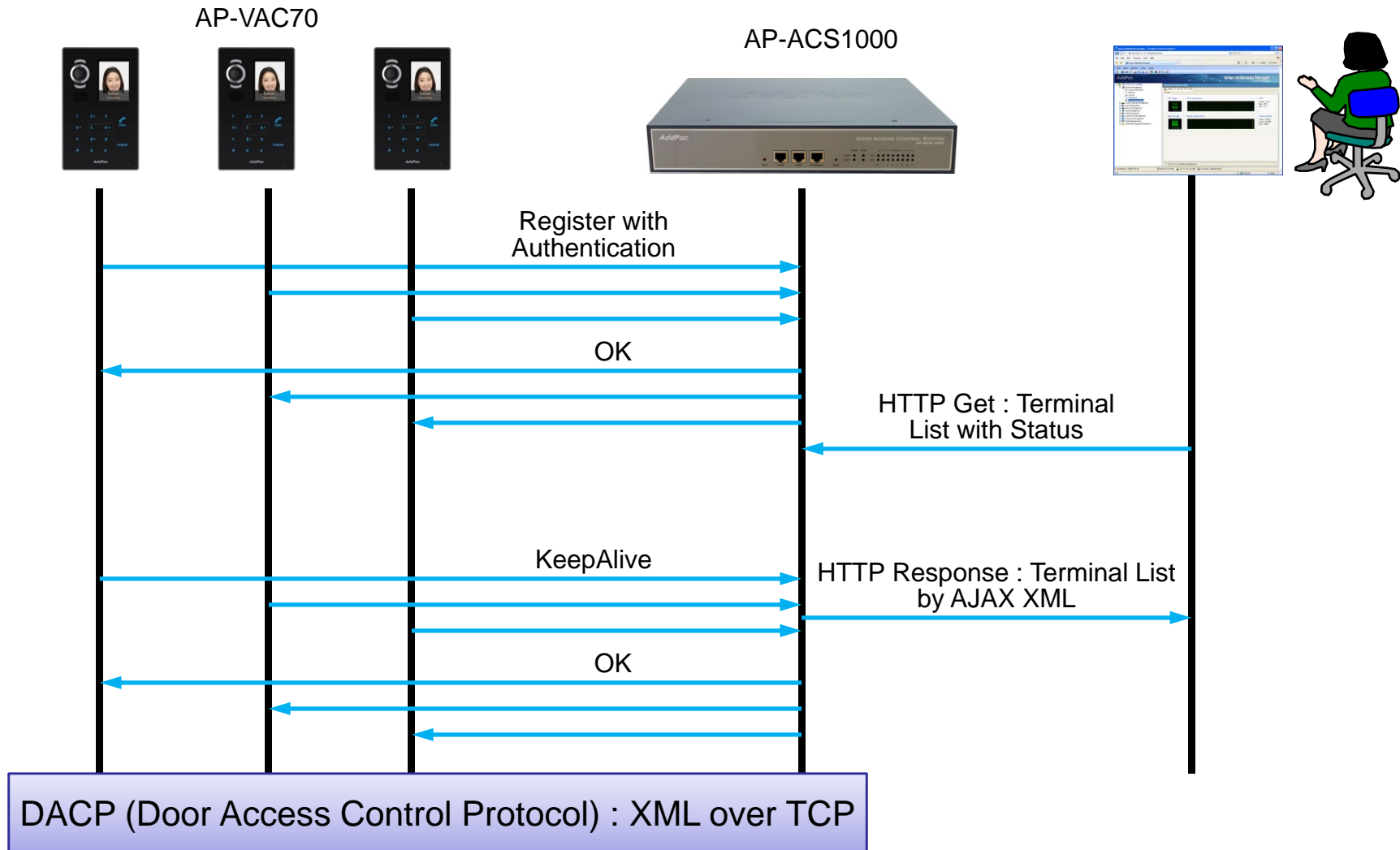

DACS System Message Flow

Access Privilege and Schedule Download

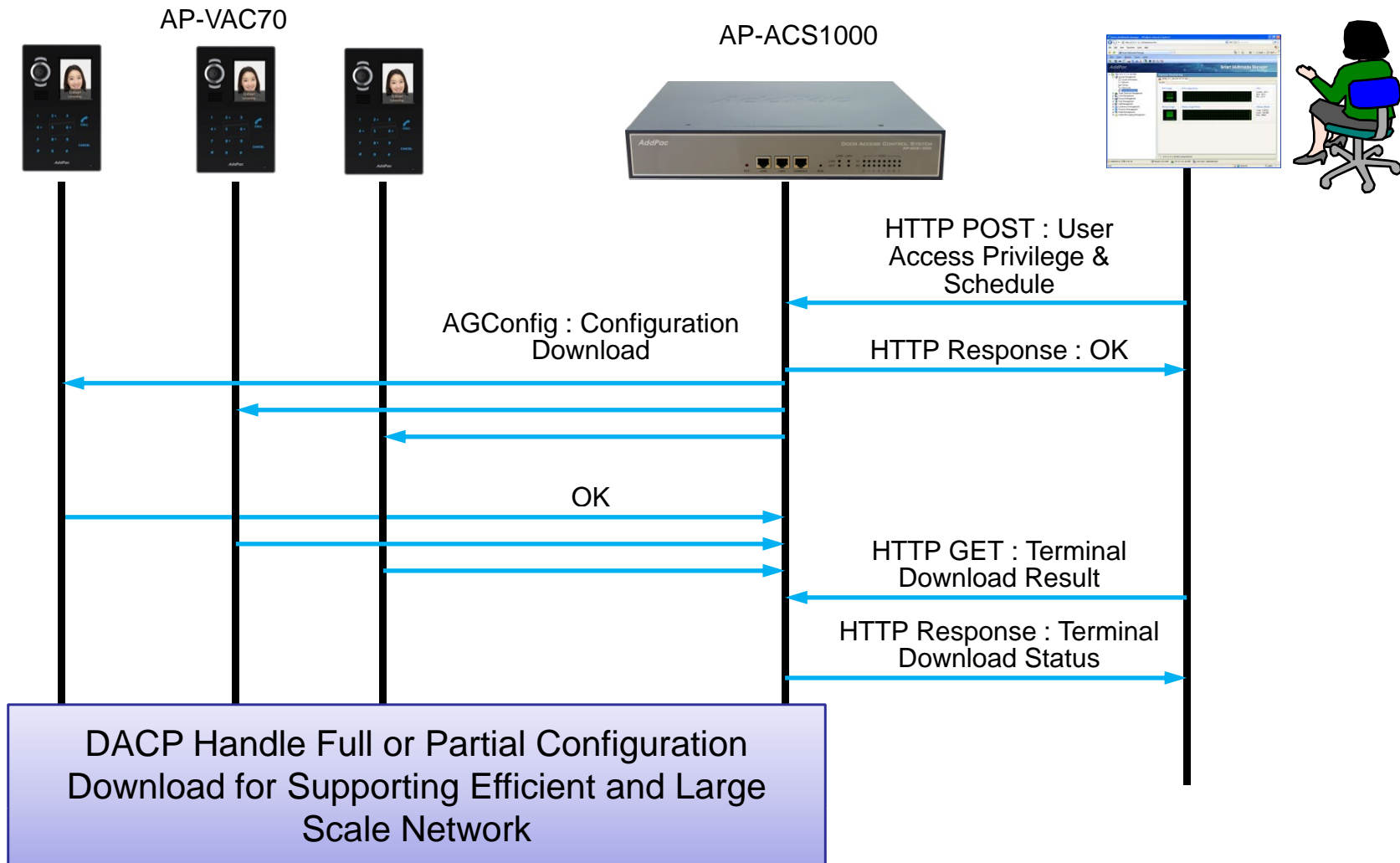

DACS System Message Flow

RF Card Read/Write and Registration

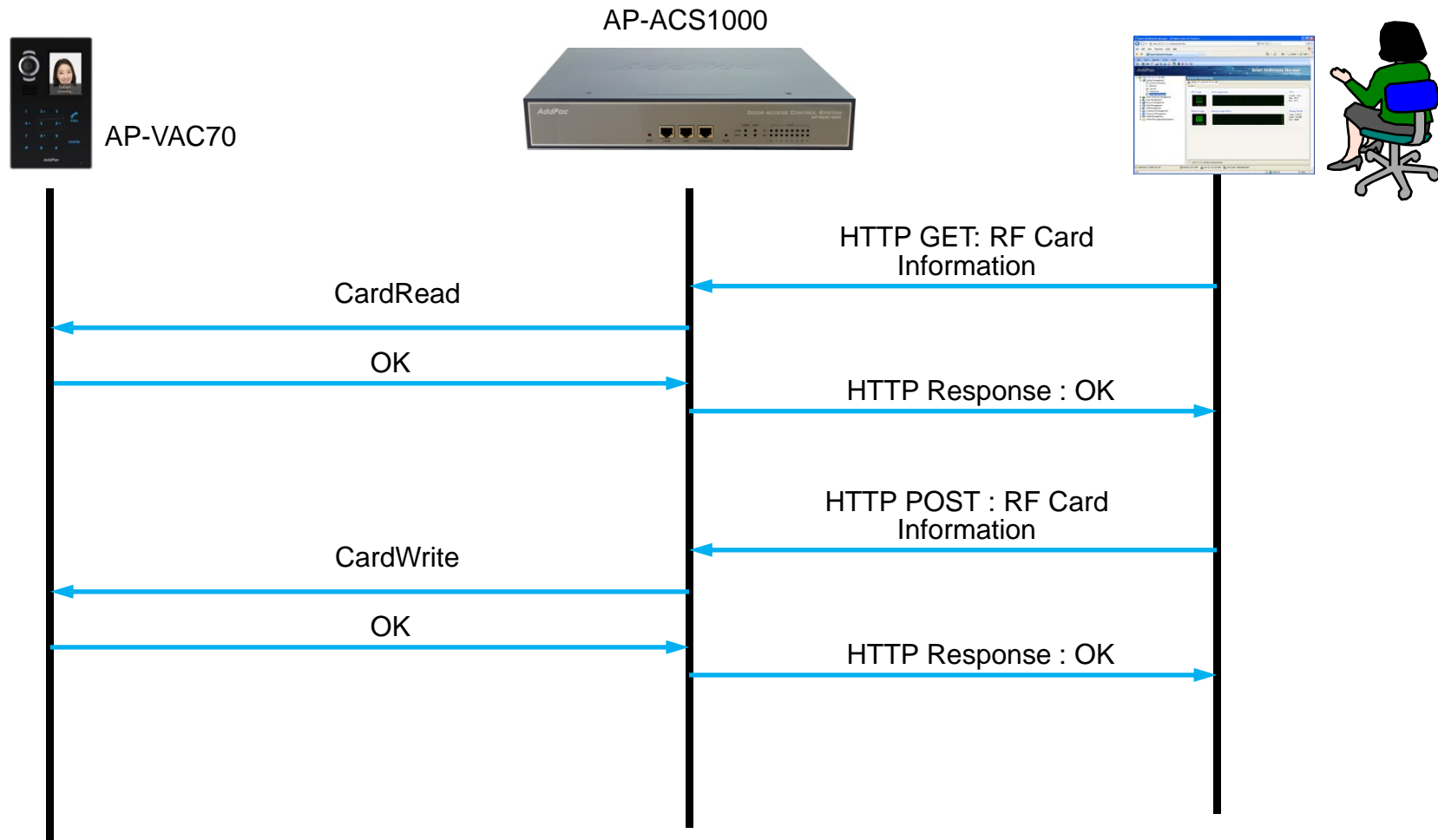

DACS System Message Flow

Door Open by RF Card or Password

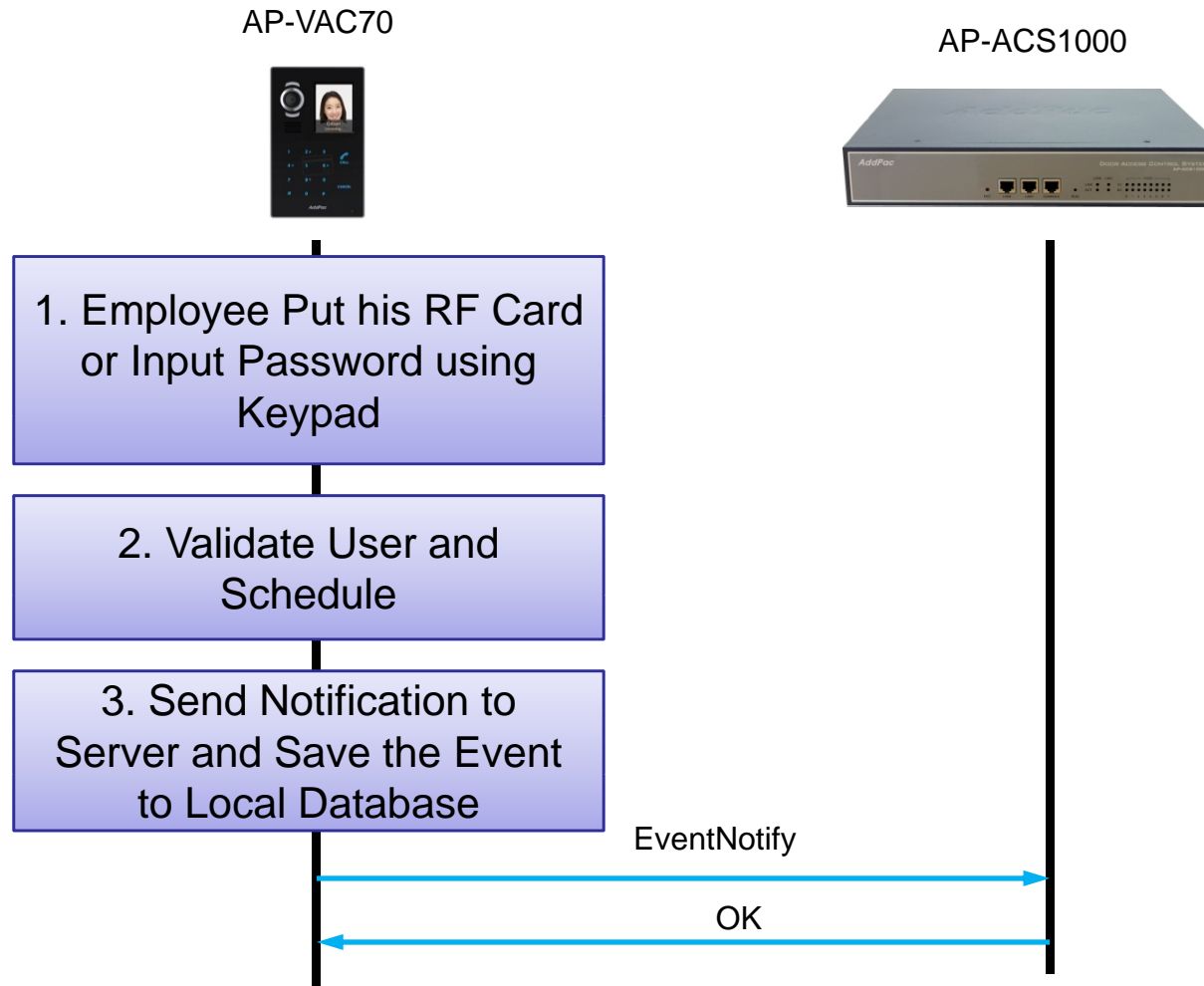

DACS System Message Flow

Door Open by Other Terminal

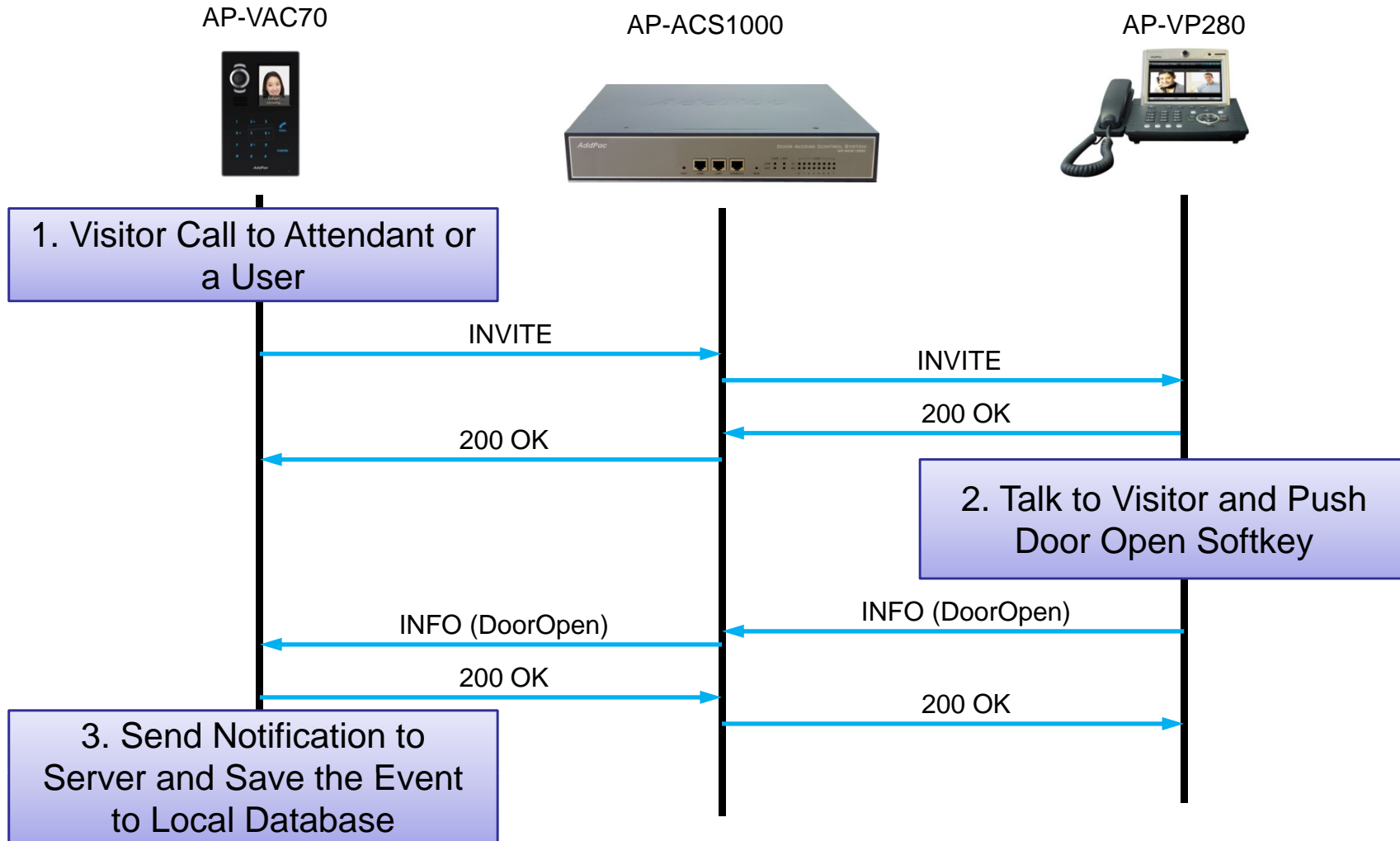



Door Access Control Manager for AP-ACS1000

DACM (Door Access Control Manager)

Main Web Page

Door Access Control Manager
AddPac ver 1.0

Help | logout
Admin (administrators)

사용자 및 단말 관리 | 카드 관리 | **출입 통제 관리** | 로그 및 보고서

화면이 갱신될 때마다 데이터 변경 여부를 판단하여 상단에 표시한다.
'여기'를 선택하여 단말기 전송 화면 실행

AddPac Technology의 출입 통제 관리 시스템에 오신것을 환영합니다.

본 시스템은 AddPac IP-Next 시스템과 연계되어 출입은 접근에 대한 사용자 및 출입 통제에 관련된 설정을 관리합니다. 아래 각 메뉴를 통해서 해당 기능을 수행할 수 있으며 상세한 설정은 왼쪽의 각 카테고리 메뉴 별로 접근할 수 있습니다.

사용자 가져오기 | 단말기 전송 | 신규 카드 발급 | 로그 조회

메뉴를 선택하여 전송 화면 실행

Copyright AddPac Technology 2011, all rights reserved

DACM (Door Access Control Manager)

Main Web Page

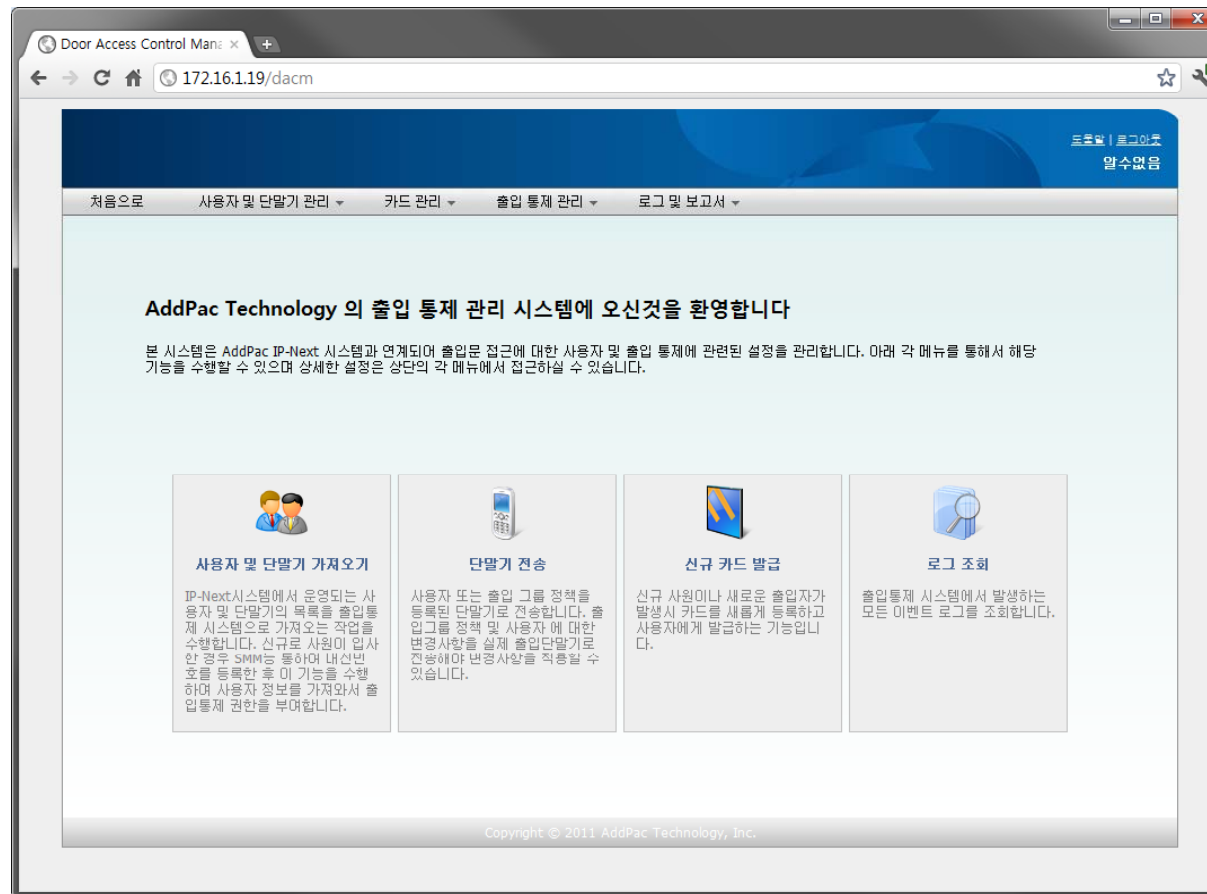

DACM (Door Access Control Manager)

User Management

Door Access Manager
AddPac ver 1.0 Help | logout
Admin (administrators)

 사용자 가져오기

IP-Next PBX에 등록된 사용자 목록을 출입통제 시스템으로 동기화 하는 기능입니다.
이 기능은 설치 초기에 한번 수행하거나 신규 사원이 PBX에 등록된 경우에 출입이 필요한 경우 본 기능을 수행하여 카드를 발급하고 출입통제를 할 수 있습니다.

사용자

1. 사용자 목록 가져오기 선택

전체 사용자: 0, 변경됨: 0, 추가됨: 0, 삭제됨: 0

<input checked="" type="checkbox"/>	내선번호	이름	부서	상태
<input checked="" type="checkbox"/>	1000	홍길동 과장	/본사/영업부	➕ 추가됨
<input checked="" type="checkbox"/>	1001	김철수 대리	/본사/해외영업부	➕ 추가됨
<input checked="" type="checkbox"/>	1002	최진석 선임	/연구소/SmartMgt	➕ 추가됨
<input checked="" type="checkbox"/>	1003	권효준	/연구소/SmartMgt	➖ 삭제됨
<input checked="" type="checkbox"/>	1004	권중휘 책임	/연구소/SmartMgt	➕ 추가됨

2. 출입 통제 그룹 정책 선택

출입통제 그룹은 사용자 별로 일괄 적용되며 여러개의 그룹을 선택하실 수 있습니다. 선택하지 않은 경우에는 정책이 반영되지 않으며 사용자 별로 정책을 설정해야 합니다.

default policy
2층 출입
5층 출입
방장 출입 그룹

설정 항목을 적용하시려면 '가져오기'버튼을 아니면 '취소'버튼을 선택하십시오.

Copyright AddPac Technology 2011, all rights reserved

DACM (Door Access Control Manager)

User Management

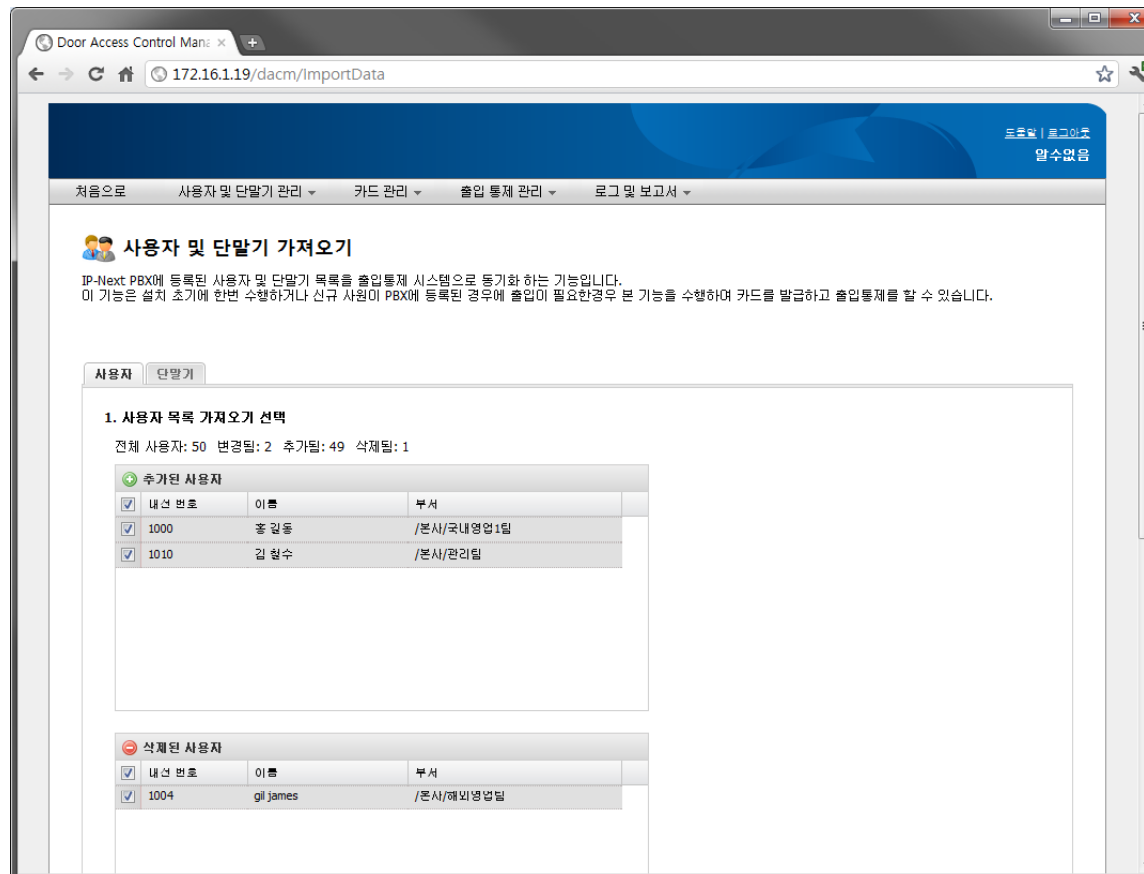

DACM (Door Access Control Manager)

Access Group Management

Door Access Control Man: x

172.16.1.19/dacm/accessGroupList

드문발 | 로그인
알수없음

처음으로 사용자 및 단말기 관리 카드 관리 출입 통제 관리 로그 및 보고서

출입 통제 그룹

등록된 출입단말기에 대해서 출입 권한 리스트 조회하거나 신규로 등록 및 수정할 수 있습니다.
출입 통제 그룹은 위/아래 화살표를 이용하여 우선순위를 조정할 수 있습니다.

출입 통제 그룹 등록

그룹 이름	설명	스케줄 정책	생성 날짜	수정	삭제
no restriction	출입제한 없음	N/A	2011-06-27 12:23:12		
3F_only	3층만 출입	N/A	2011-06-27 12:23:12		
research_only	연구수 출입 정보	working_day	2011-06-27 12:23:12		
5Floor	5층연구수	working_day	2011-06-27 12:23:12		
관리사무소	관리사무소 출입 정보	working_day	2011-06-27 12:23:12		

페이지 1 / 1

Displaying 1 - 5 of 5

DACM (Door Access Control Manager)

Configuration Download to Terminal

The screenshot shows the 'Door Access Control Manager' web interface. The header includes the title 'Door Access Control Manager', version 'ver 1.0', and a warning message: '설정이 변경되었습니다. 설정을 반영하시려면 '여기'를 클릭하여 단말기 동기화를 하십시오.' (Settings have been changed. Click 'here' to refresh the terminal synchronization settings). The navigation menu includes '사용자 및 단말 관리', '카드 관리', '출입 통제 관리', and '로그 및 보고서'. The main content area is titled '단말기 전송' (Terminal Transfer) and contains a table of terminal configurations.

<input checked="" type="checkbox"/>	장비명	IP 주소	접속 상태	변경 여부	전체 동기화
<input type="checkbox"/>	3F door phone	172.16.10.5	접속됨	변경사항 없음	
<input checked="" type="checkbox"/>	lobby entrance	172.16.5.20	접속끊김	변경됨	
<input checked="" type="checkbox"/>	5F door phone	172.16.10.6	접속됨	변경됨	
<input checked="" type="checkbox"/>	factory main	172.16.10.8	접속됨	변경사항 없음	전체 반영 필요

동기화가 필요 없는 경우에는 check 가 해지된다. 강제로 하고자 하는 경우 check하면 된다.

위 선택된 단말기에 데이터를 전송하려면 아래 '전송' 버튼을 선택하거나 작업을 취소하시려면 '취소' 버튼을 선택하십시오.

Buttons: 전송, 취소

Copyright AddPac Technology 2011. all rights reserved.

DACM (Door Access Control Manager)

RF Card Management

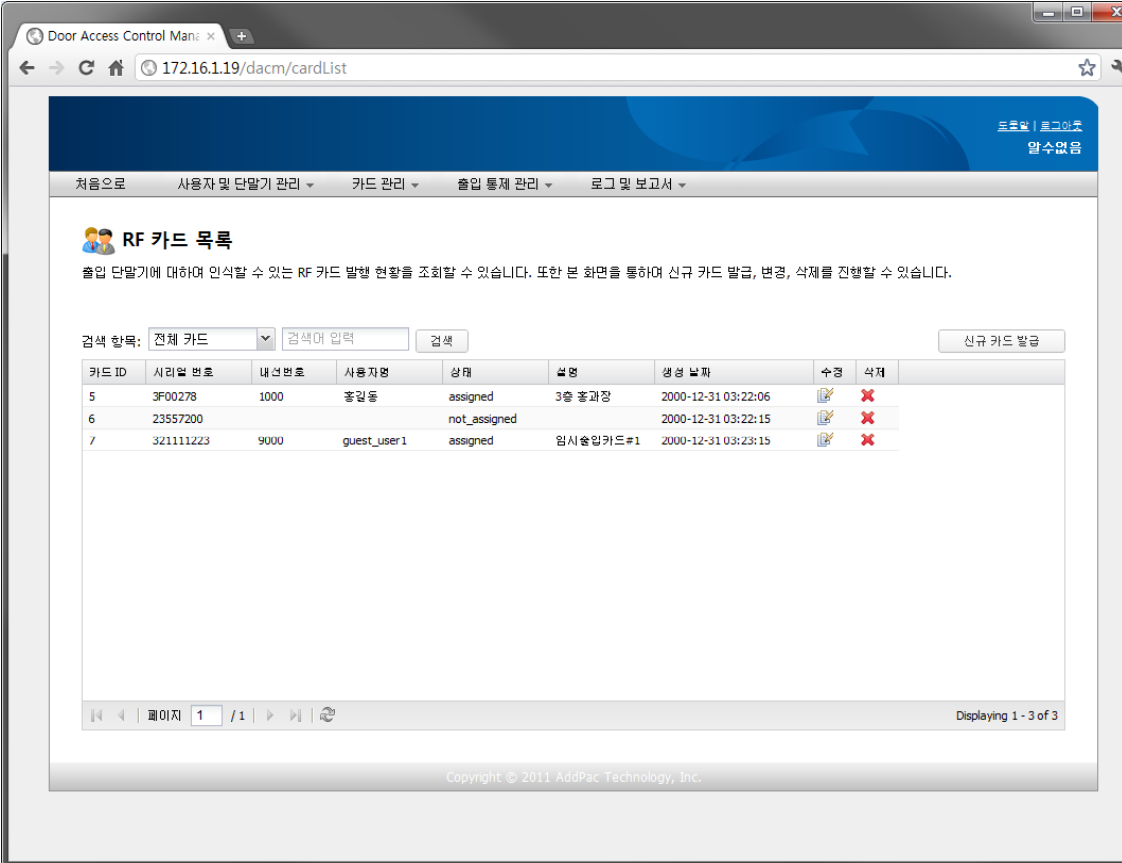

Door Access Control Manager

172.16.1.19/dacm/cardList

로그인 | 로그아웃
알수없음

처음으로 사용자 및 단말기 관리 카드 관리 출입 통제 관리 로그 및 보고서

RF 카드 목록

출입 단말기에 대하여 인식할 수 있는 RF 카드 발행 현황을 조회할 수 있습니다. 또한 본 화면을 통하여 신규 카드 발급, 변경, 삭제를 진행할 수 있습니다.

검색 항목: 전체 카드 검색어 입력 검색 신규 카드 발급

카드 ID	시리얼 번호	내선번호	사용자명	상태	설명	생성 날짜	수정	삭제
5	3F00278	1000	종업원	assigned	3층 종과장	2000-12-31 03:22:06		
6	23557200			not_assigned		2000-12-31 03:22:15		
7	321111223	9000	guest_user1	assigned	임시출입카드#1	2000-12-31 03:23:15		

페이지 1 / 1

Displaying 1 - 3 of 3

Copyright © 2011 AddPac Technology, Inc.

DACM (Door Access Control Manager)

Access Log Management

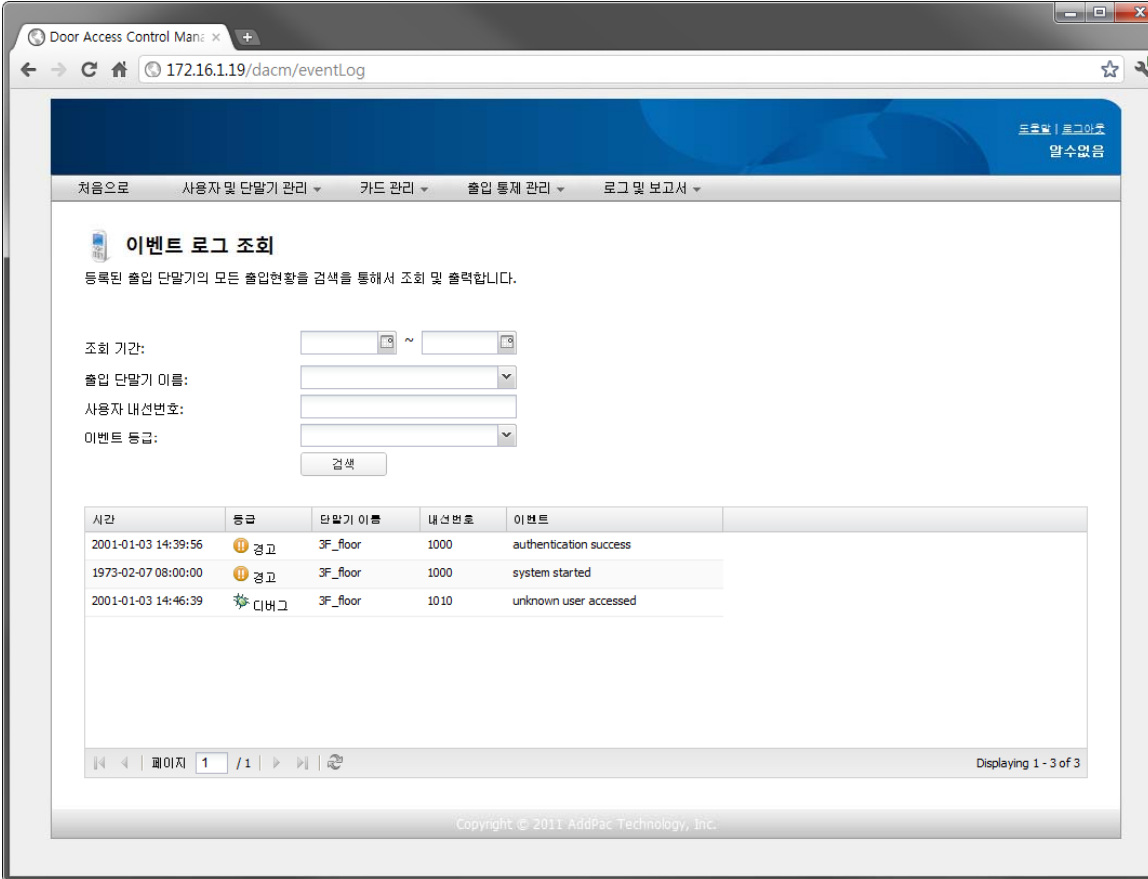

Door Access Control Manager

172.16.1.19/dacm/eventLog

도호빌 로그아웃
알수없음

처음으로 사용자 및 단말기 관리 카드 관리 출입 통제 관리 로그 및 보고서

이벤트 로그 조회

등록된 출입 단말기의 모든 출입현황을 검색을 통해서 조회 및 출력합니다.

조회 기간: ~

출입 단말기 이름:

사용자 내선번호:

이벤트 등급:

검색

시간	등급	단말기 이름	내선번호	이벤트
2001-01-03 14:39:56	경고	3F_floor	1000	authentication success
1973-02-07 08:00:00	경고	3F_floor	1000	system started
2001-01-03 14:46:39	디버그	3F_floor	1010	unknown user accessed

페이지 1 / 1

Displaying 1 - 3 of 3

Copyright © 2011 AddPac Technology, Inc.



AP-ACS1000 Open API

Open API

Open API for 3'rd Party Management System

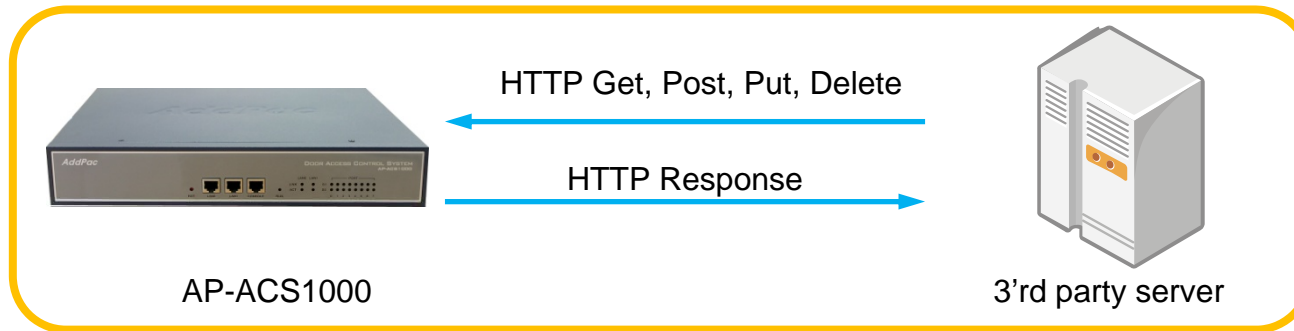

- HTTP based RESTful Open API for Door Access Management
- XML based Flexible and Expandable Message Contents
- Provides More than 40 APIs as Bellow
 - user_list(GET), user(GET, POST, PUT, DELETE), ...
 - terminal_list(GET), terminal(GET, POST, PUT, DELETE), ...
 - access_group(GET, POST, PUT, DELETE), priority (PUT), ...
 - card_list(GET), card(POST, PUT, DELETE), ...
 - schedule_template(GET, POST, PUT, DELETE), rule(GET, POST, PUT, DELETE) ,...



HD IP Video Door Phones

IP Video Door Phone Comparison Table

Model	AP-VAC250	AP-VAC70
Service Features		
Duplex (Voice)	Full Duplex	Full Duplex
Key Pad	3x4 Key Support	3x4 Key Support
LCD	3.5 Inch	2inch LCD
RF Card	Support	Support
Fingerprint	Support	N/A
Video Camera	720P HD CMOS Sensor	720P HD CMOS Sensor
Video Codec	H.264/MPEG4	H.264/MPEG4
Voice Codec	G.711	G.711
Signaling	H.323/SIP	H.323/SIP
MIC & Speaker Phone	Support	Support
LAN Port	1	1
PoE(Optional)	Support	Support



AP-VAC250

HD IP Video Door Phone

Main Features

AP-VAC250 Fingerprint Recognition HD IP Video Door Phone

- High Performance HD IP Video Door Phone Solution
- HD Video Camera, 3x4 Key, TFT Color LCD, Internal MIC & Speaker
- High Quality 3.5 Inch LCD, 320 x 240 Video Resolution
- Fingerprint Recognition, RF Card Support
- SIP VoIP Signaling Stack Embedded
- High-performance Video/Voice Codec Support
 - H.264/MPEG4, G.711, etc
- One(1) 10/100Mbps Fast Ethernet
- PoE(Power over Ethernet) Support
- High Quality Speaker Phone Features
- Powerful Acoustic Echo Canceller Chip Embedded
- Powerful Network Protocols (PPPoE, DHCP, Static Routing, etc)
- Firmware Upgradeable Architecture
- Advanced Voice QoS Mechanism
- Die Casting Chassis

Hardware Specification

AP-VAC250 Fingerprint Recognition HD IP Video Door Phone

RISC
CPU

High-end
DSP

- RISC+DSP Microprocessor Computing Power
- Audio and Voice Interface
 - Internal MIC
 - Internal Speaker
 - 3 x 4 key PAD
- HD Video Camera Interface
- TFT Color LCD Interface
 - 3.5 Inch LCD, 320 x 240 Video Resolution
- Network Interface
 - One(1) 10/100Mbps Fast Ethernet
- Fingerprint Recognition Interface
- RF Card Interface
- Alarm & Relay Out Interface (door open, etc)
- RS232/RS485 Interface
- External RCA Audio Line Out and MIC In (back side)
- STILL Chassis
- Power Supply
 - Power over Ethernet (Option)
 - External Power Supply



Hardware Specification

AP-VAC250 Fingerprint Recognition HD IP Video Door Phone

RISC
CPU

High-end
DSP

Front Side

Internal Speaker

HD Video Camera
Sensor

LED Side Light

RF Card Sensor

Status LED

Fingerprint
Recognition

TFT LCD Display

Remote Image

Local Image

3 x 4 Dial Key

STILL Chassis

Internal MIC Input

AddPac

www.addpac.com

Hardware Specification

AP-VAC250 Fingerprint Recognition HD IP Video Door Phone

RISC
CPU

High-end
DSP

Back Side

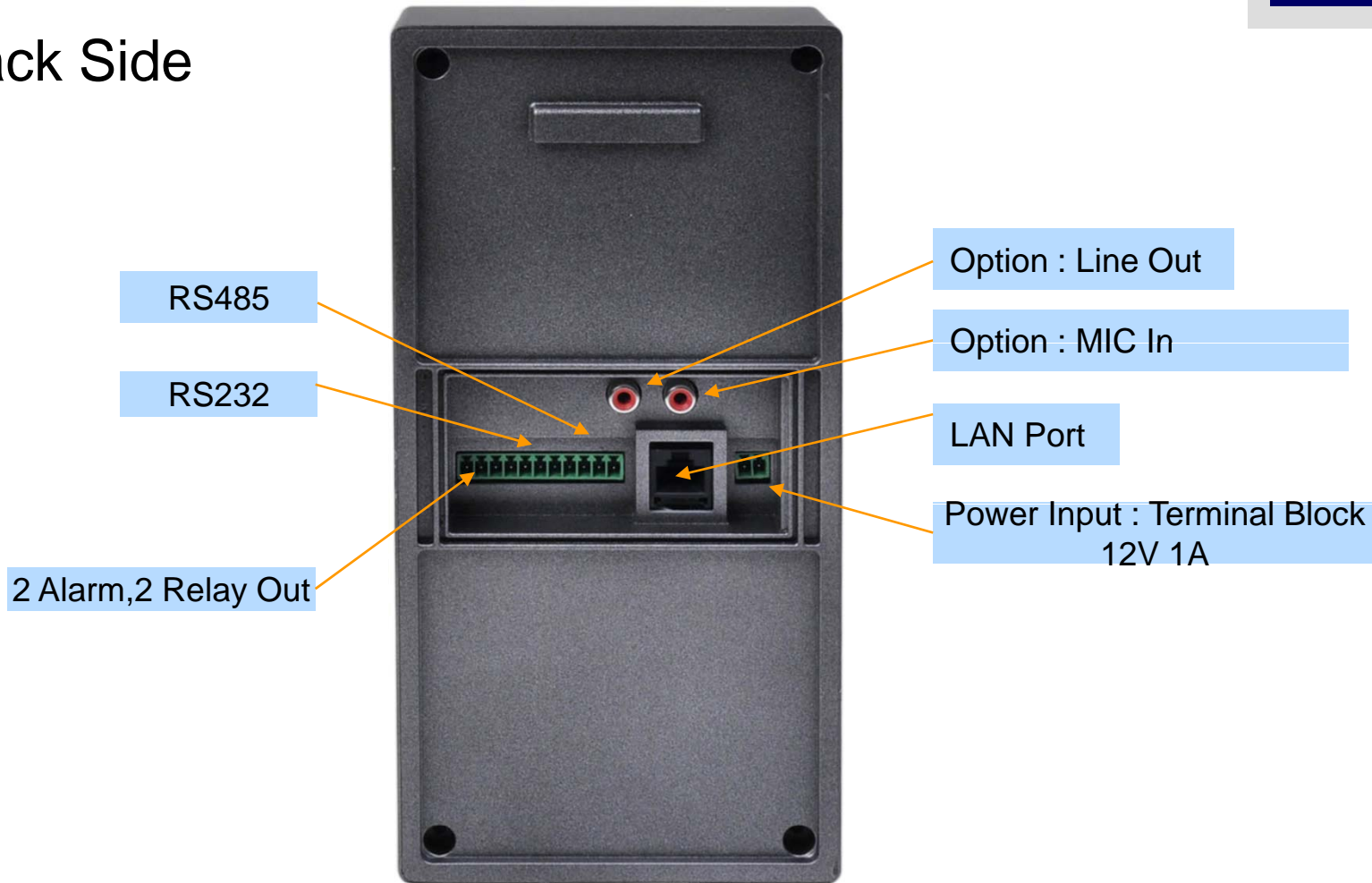

Hardware Specification

AP-VAC250 Fingerprint Recognition HD IP Video Door Phone

RISC
CPU

High-end
DSP

Power Supply

Terminal Block



12V 1A Power Adaptor

Example





AP-VAC70

HD IP Video Door Phone

Main Features

AP-VAC70 HD IP Video Door Phone

- High Performance IP HD Video Door Phone Solution
- 3x4 Key, TFT Color LCD, Internal MIC & Speaker
- Wide Dynamic Range(WDR) HD Video Camera CMOS Image Sensor
- H.264 AVC 720P HD Video Codec Support
- High Quality 2.4 Inch LCD, 320 x 240 Video Resolution
- SIP VoIP Signaling Stack Embedded
- High-performance Video/Voice Codec Support
- One(1) 10/100Mbps Fast Ethernet
- PoE(Power over Ethernet) Support
- High Quality Speaker Phone Features
- Powerful Acoustic Echo Canceller Chip Embedded
- Powerful Network Protocols (PPPoE, DHCP, Static Routing, etc)
- Firmware Upgradeable Architecture
- Advanced Voice QoS Mechanism
- Option : Die Casting Chassis

Hardware Specification

AP-VAC70 IP HD Video Door Phone

RISC
CPU

High-end
DSP

- RISC+DSP Microprocessor Computing Power
- Audio and Voice Interface
 - Internal MIC
 - Internal Speaker
 - 3 x 4 key PAD
- HD Video Camera Image Sensor
- TFT Color LCD Interface
 - 2.4 Inch LCD, 320 x 240 Video Resolution
- Network Interface
 - One(1) 10/100Mbps Fast Ethernet
- RF Card Interface
- Alarm & Relay Out Interface (door open, etc)
- RS232/RS485 Interface
- External RCA Audio Line Out and MIC In (back side)
- Power Supply
 - Power over Ethernet (Option)
 - External Power Supply



Hardware Specification

AP-VAC70 HD IP Video Door Phone

RISC
CPU

High-end
DSP

Front Side

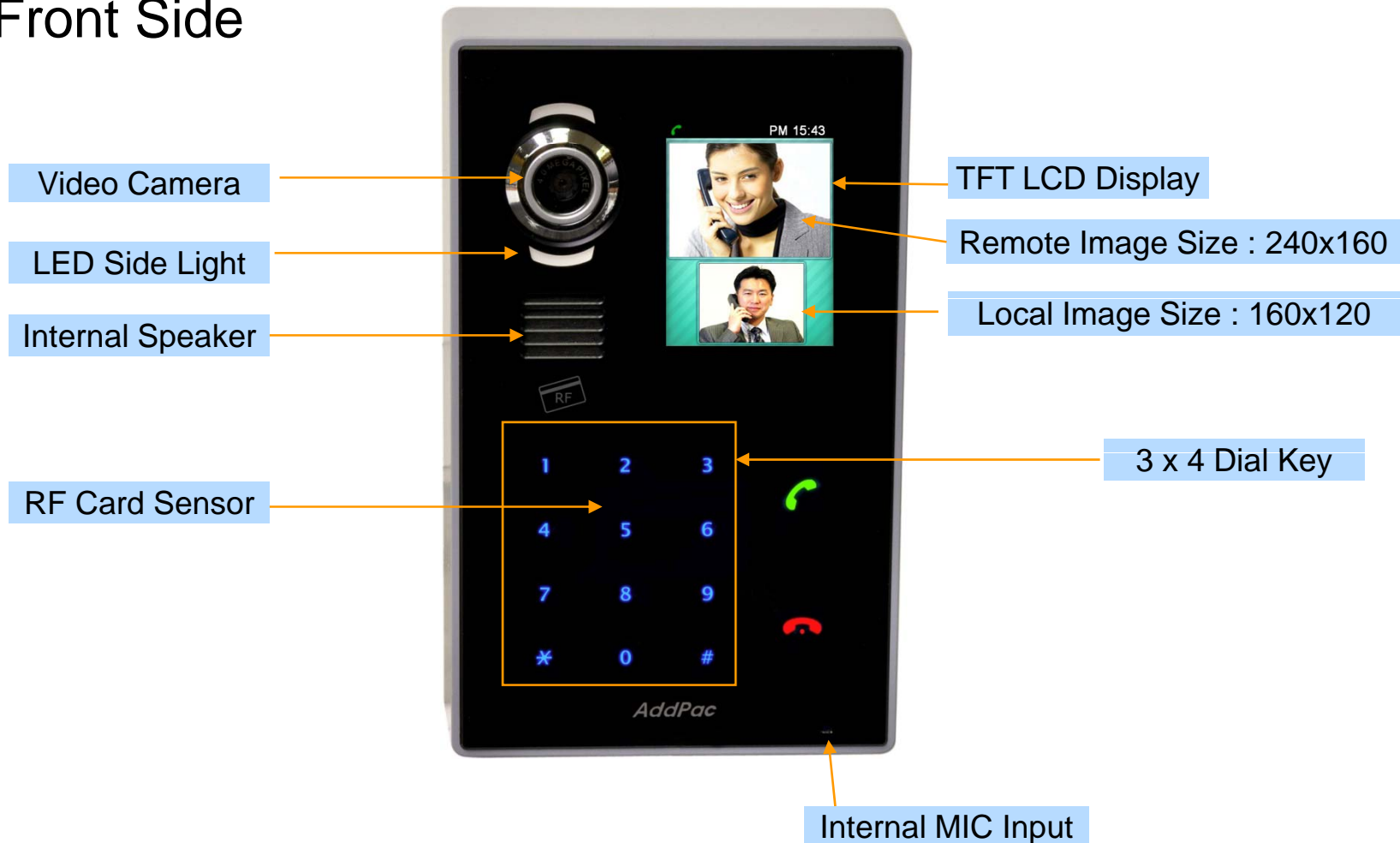

Hardware Specification

AP-VAC70 HD IP Video Door Phone

RISC
CPU

High-end
DSP

Back Side

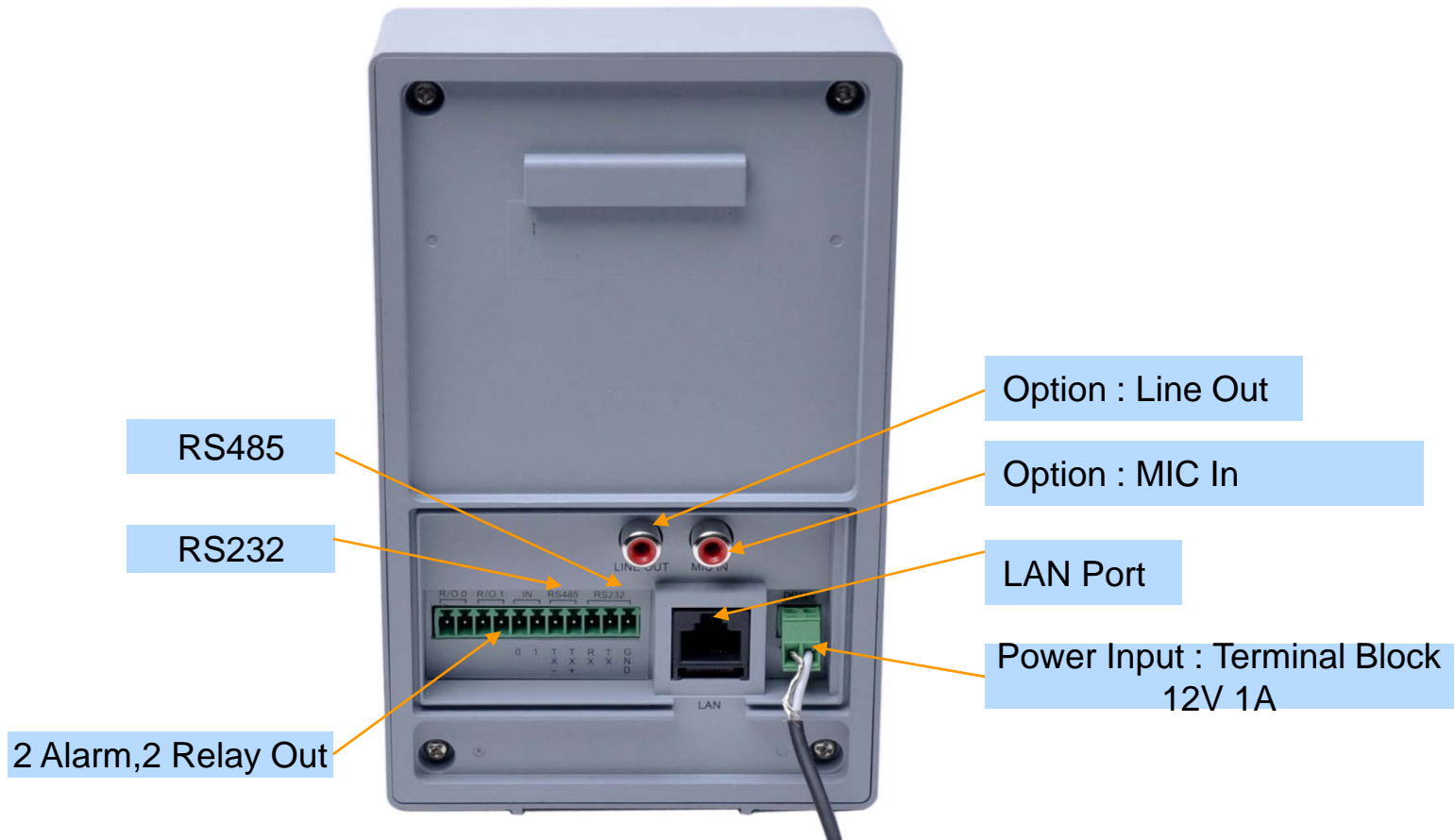



Smart Web Manager for HD IP Video Door Phone

Smart Web Manager

- Main Screen
- System
 - Language
 - LAN Setup
 - DACS
 - Display
 - File Browser
- SIP Call & Media
 - SIP (Session Initiation Protocol)
 - Speed Dial
 - Media
- Miscellaneous
 - Door Control and Test
 - Network Test



Smart Web Manager : Main Screen

The screenshot displays the Smart Web Manager interface with the following components:

- Header:** "Smart Web Manager" and "www.addpac.com" on the left; navigation icons for "Initialization", "Rebooting", "Save", and "Telnet" on the right.
- Menu Tree (Left):**
 - System:** Language, LAN Setup, DACS, Display Manager, File Browser
 - Call & Media:** Server SIP, Speed Dial, Media
 - Miscellaneous:** Ping, Door Open
- Configure Language (Center):**
 - Radio buttons for "한국어" and "English" (selected).
 - "Apply" button with a green checkmark.
- Information (Right):**
 - System details: AddPac Technology, Model: VAC50_G2, DACS: (0), DACS Registration: Fail, SIP: 172.17.250.250(5060).
 - Description:** "Choose the basic language to be applied. English is set at default."

Menu Tree

Output Screen after
Menu Select

System Information and
Help Message

Smart Web Manager : SIP configuration

SIP (Session Initiation Protocol)

SIP server check if exist.

SIP Basic Information Display

Telephone Line Number and Password Configuration
Same Information is used when DACS is connected

Use SIP Server

Yes No

Primary SIP Server

172.17.250.250 5060 Server address and Port (default 5060)

Secondary SIP Server

5060 Server address and Port (default 5060)

Local Domain Name

(SIP userpart of authentication)

SIP Signaling Port

5060 (default 5060, between 1 to 65535)

Register Expiration

60 (in seconds, default 60, between 10 to 86400)

Session Re-Fresh

INVITE UPDATE

Session Expire Time

1800 (in seconds, default 1800, between 30 to 86400, 0 = disable)

Min-SE

1800 (in seconds, default 1800, between 30 to 86400)

Extension

1020 Extension Number, Password

AP-SMP100 IP Video Soft Phone



Main Features

AP-SMP100 IP Video Soft Phone

- MS-Window based Soft-Phone
- Smart Multimedia (Video/Voice) Soft-Phone
- IP Real-time Audio/Video Broadcasting Terminal Solution
- Built-In Smart Messenger Function
- Up to 30fps with VGA-Resolution(MPEG4, H.264)
- Video Conference Call Support (AddPac External MCU Inter-working)
- Advanced Voice/Video Traffic QoS
- SIP, H.323* Signaling Support
- Support Various Call Signal via AddPac IP-PBX Inter-working

OSD Software Features

AP-SMP100 IP Video Soft Phone



OSD Software Features

AP-SMP100 IP Video Soft Phone



OSD Software Features

AP-SMP100 IP Video Soft Phone



OSD Software Features

AP-SMP100 IP Video Soft Phone



- ⑥ Configuration - 설정화면 실행버튼
- ⑦ Dialpad - 다이얼패드 실행버튼
- ⑧ Video On/Off - 통화중 영상화면 온/오프
- ⑨ Audio On/Off - 통화중 음성 온/오프
- ⑩ Scale Up Down - 영상화면 크기변경
- ⑪ Split Screen - 영상화면 분리버튼

- ① File
 - Edit Preference
 - Edit Call Manager
 - Set Audio Option
 - Set Video Option
 - Close
- ② View
 - Dial Pad
 - Zoom In
 - Zoom Out
- ③ Session
 - Connect Call
 - End Call
 - Volume Up
 - Volume Down
 - Audio On/Off
 - Video On/Off
- ④ Soft-Key
 - Redial
 - Pickup
 - GroupPickup
 - CCBS
- ⑤ Help
 - About



Thank you!

AddPac Technology Co., Ltd.
Sales and Marketing

Phone +82.2.568.3848 (KOREA)

FAX +82.2.568.3847 (KOREA)

E-mail : sales@addpac.com