

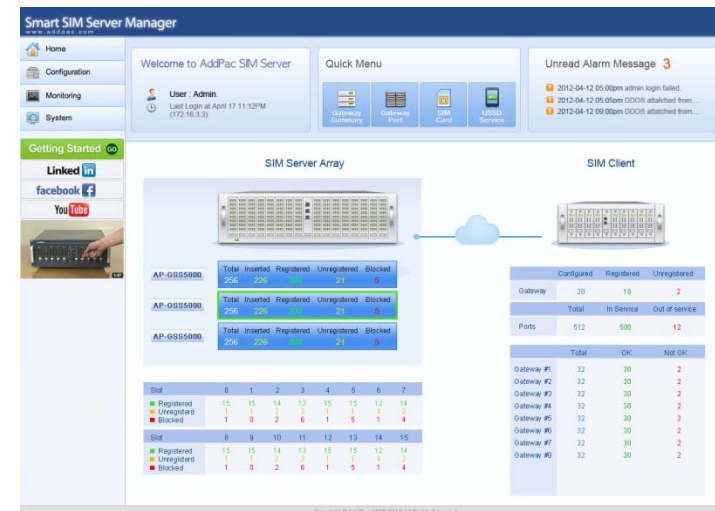

AP-GSS1500™

256Ch GSM SIM Server

High Performance GSM SIM Server Solution



AddPac

AddPac Technology

2013, Sales and Marketing

www.addpac.com

Contents

- Product Overview
- Hardware Specification
- SIM Bank Module Specification
- Dimension Comparison (AP-GS3000 & AP-GSS1500)
- APOS Technology
- Network Protocols
- Network Management
- Security Management
- Smart Web Manager for SIM Serve
- Application Service
- Ordering Information



Product Overview

AP-GSS1500 GSM SIM Server

- Octal(8) Module Slots for 32ch SIM Bank Module (Up to 32x8=256ch SIM Slot, CPU Module)
- High Performance RISC Microprocessor Architecture
- Remote SIM solution for Centralized Management
- Hot-Swap Service for SIM Bank Module
- Powerful Real-time Response Service using Embedded RTOS
- Powerful Network Protocols (PPPoE, DHCP, Static Routing, etc)
- Two(2)10/100/1000Mbps Gigabit Ethernet
- One(1) RS-232C Port for Command Line Interface
- Firmware Upgradeable Architecture
- Smart Web Manager for GSM SIM Server
- High Density and Compact Size Design
- Internal Power Supply

Product Highlights

AP-GSS1500 GSM SIM Server

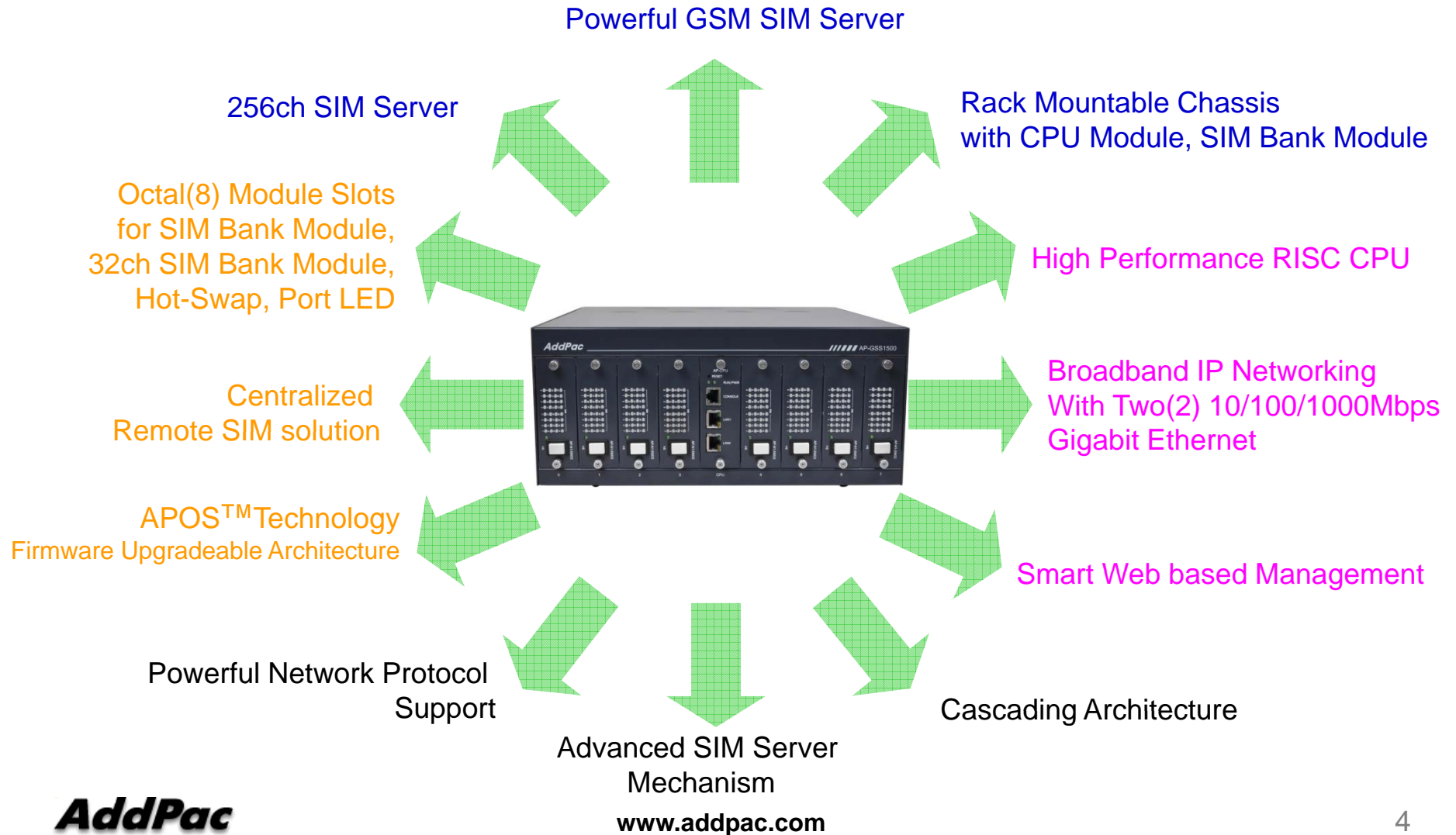

APOS Technology

AP-GSS1500 GSM SIM Server

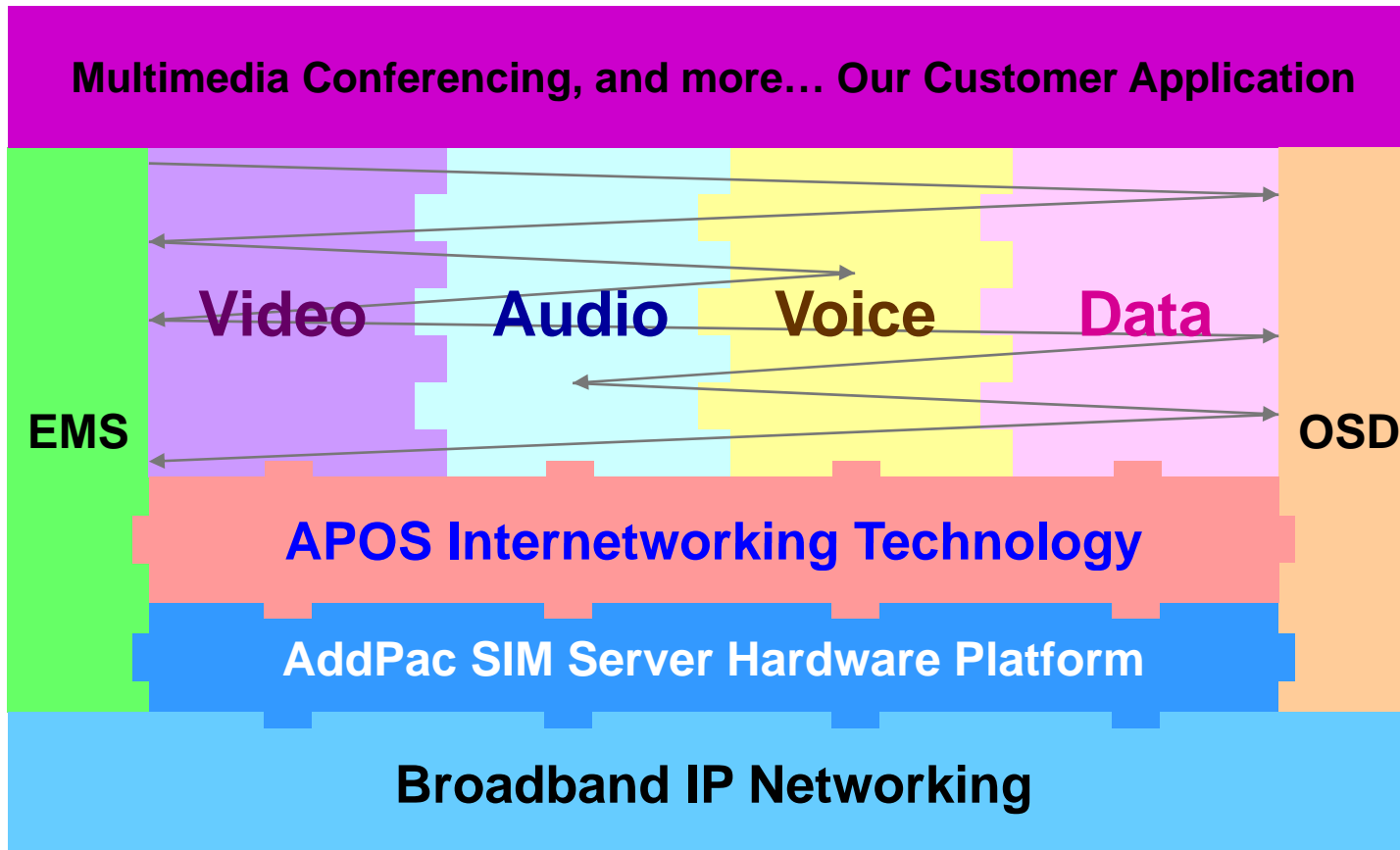

- APOS : AddPac Internetworking Operating System
- OSD : On- Screen Display
- EMS : Element Management System

Hardware Specification

AP-GSS1500 GSM SIM Server

RISC
CPU

- RISC Microprocessor Computing Power
- High Performance CPU Module
- Octal(8) SIM Bank Module Slots
- 32ch GSM SIM Slot Module(AP-N1-SIM32)
 - 32ch SIM Card Slot
 - SIM Slot Status Port LED
 - Hot-Swap Button
- Network Interface
 - Two(2) 10/100/1000Mbps Gigabit Ethernet (RJ45)
- RS232C Console Interface for CLI
- Run LED, LAN LED, Port LEDs
- Module Type Power Supply

Hardware Specification

AP-GSS1500 GSM SIM Server

RISC
CPU

AP-GSS1500 GSM SIM Server	Basic Specifications
Voice Interface	Octal(8) Module Slots excluding CPU Module
	AP-N1-SIM32 : 32channel GSM SIM Slot Module, Hot-Swap, Port Status LED
Ethernet Interface	2-Ports 10/100/1000Mbps Gigabit Ethernet Interface(RJ-45)
Flash Memory	512Mbyte NAND Flash Memory
Base Memory	128Mbyte High-speed DDR2
Power Requirement	Power Supply / VAC 110~220V, 50/60Hz, 5V 8A, Power Supply
Operating Temperature	0°C ~ 45°C (32 °F ~ 122°F)
Storage Temperature	-40°C ~ 85°C (-40°C ~ 185°F)
Relative Humidity	5% ~ 95% (Non-condensing)
Dimensions	H x W x D (148mm x 340mm x 300mm)
Weight(kg)	5.5kg

Hardware Specification

AP-GSS1500 GSM SIM Server



Front Side View

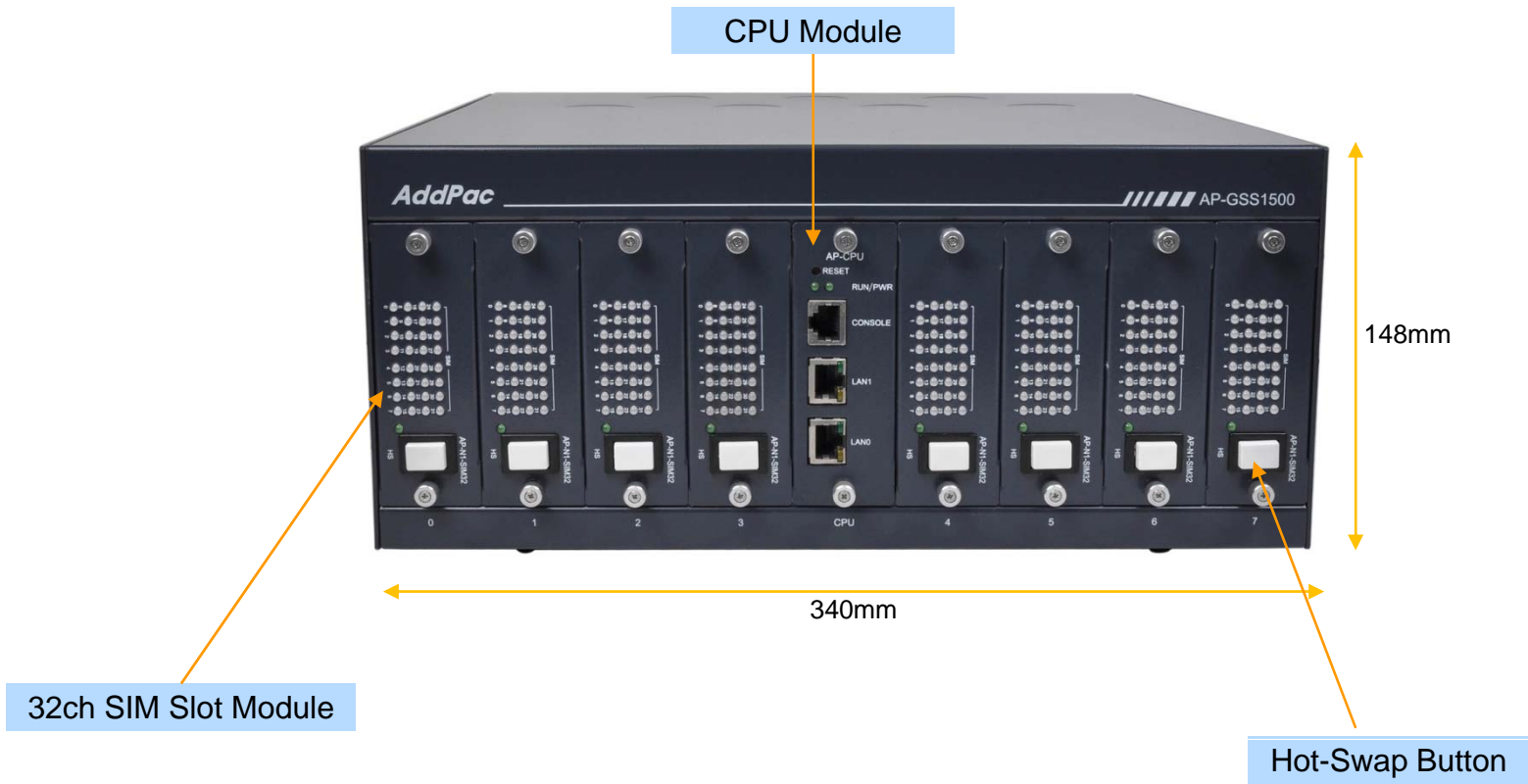

Hardware Specification

AP-GSS1500 GSM SIM Server

RISC
CPU

Back Side View



SIM Bank Module Specification

AP-GSS1500 GSM SIM Server

SIM Bank Module

AP-N1-SIM32 32ch GSM SIM Slot Module

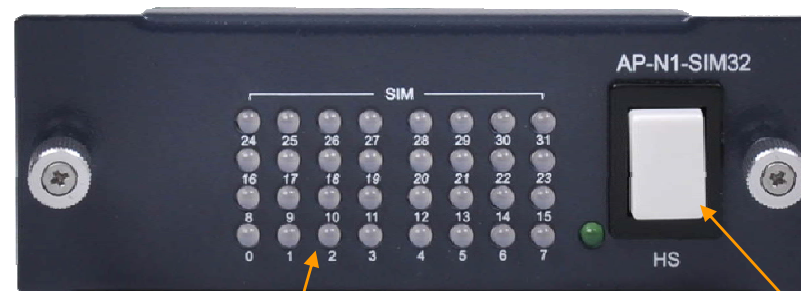

SIM Status LED :
Dual Color LED

Hot-Swap Button

SIM Bank Module Specification

AP-GSS1500 GSM SIM Server

RISC
CPU

GSM SIM Server Service Diagram

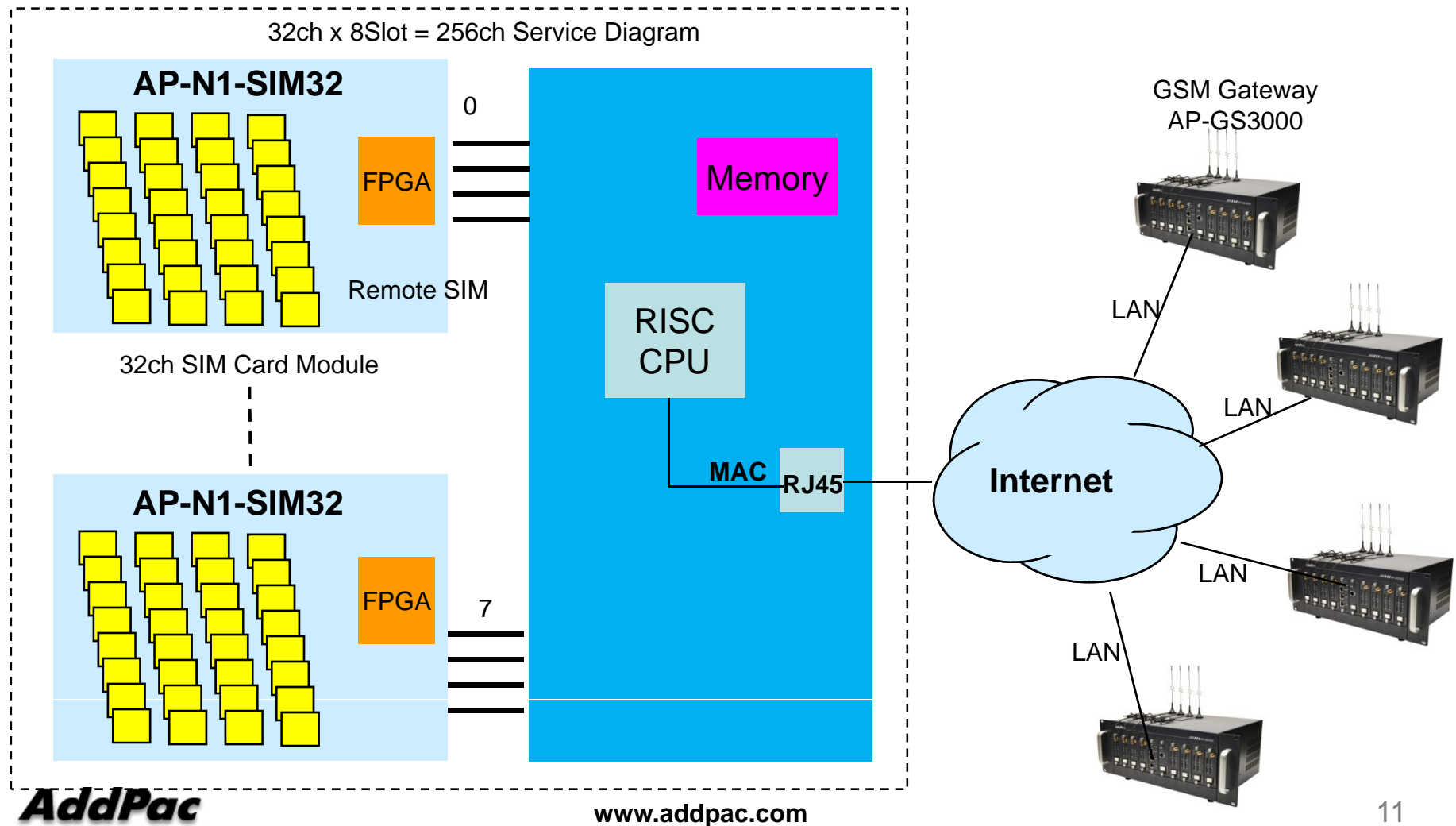

Dimension Comparison

AP-GSS1500 GSM SIM Server

AP-GSS1500
GSM SIM Server



AP-GS3000
GSM Gateway

Network Protocols

AP-GSS1500 GSM SIM Server

Basic Network Protocols

- ARP, IPv4, TCP, UDP, ICMP, SCTP, IGMP, MLD

Routing Protocol

- IPv4 : Static

Service Protocol

- FTP, Telnet, TFTP, DHCP Server/Relay, SNMP Server
- CDP (Cisco Discovery Protocol)
- DNS Resolver , DDNS(nsupdate)
- Bridge
- Syslog

IPv4 Address Configuration

- Fixed (Static)
- DHCP
- PPPoE

Miscellaneous

- Cisco Style CLI
- Standard & Extended IPv4 Access List
- Multi-level User Account Management
- IP accounting
- STUN Client

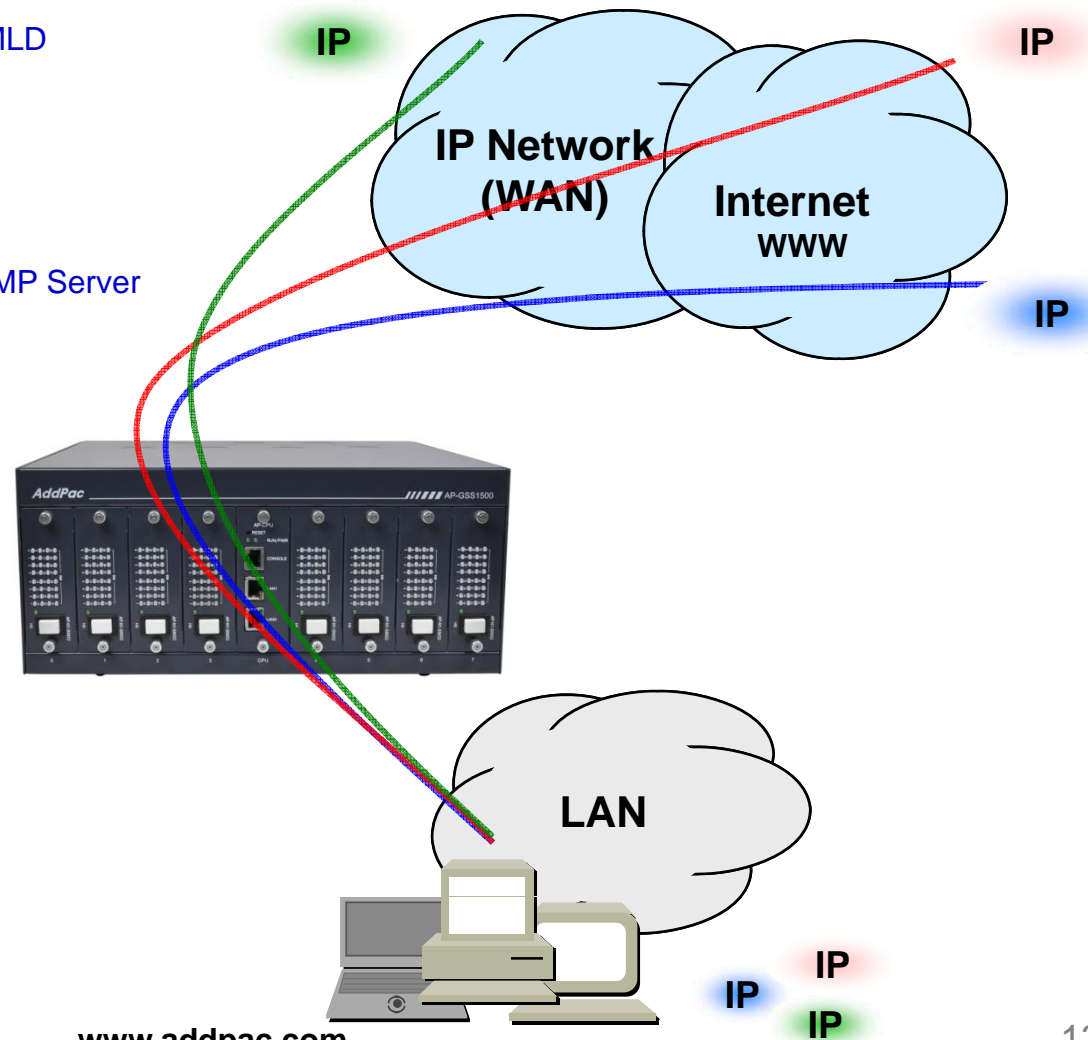

Network Management

AP-GSS1500 GSM SIM Server

- SNMP
 - Standard Simple Network Management Protocol(SNMP) Agent support
 - MIB v1 and v2 Support
- Web-based Management
 - Smart Web Manager
- Watch-dog Function
 - Hardware, Software watch-dog services
- Remote Management
 - Telnet
 - Rlogin
- Auto Upgrade Service
 - HTTP server based APOS image and configuration file auto-upgrade support
- Batch Job Function
 - Text based script downloading
- Interoperable with Smart NMS Service
 - AddPac Smart Network Management System

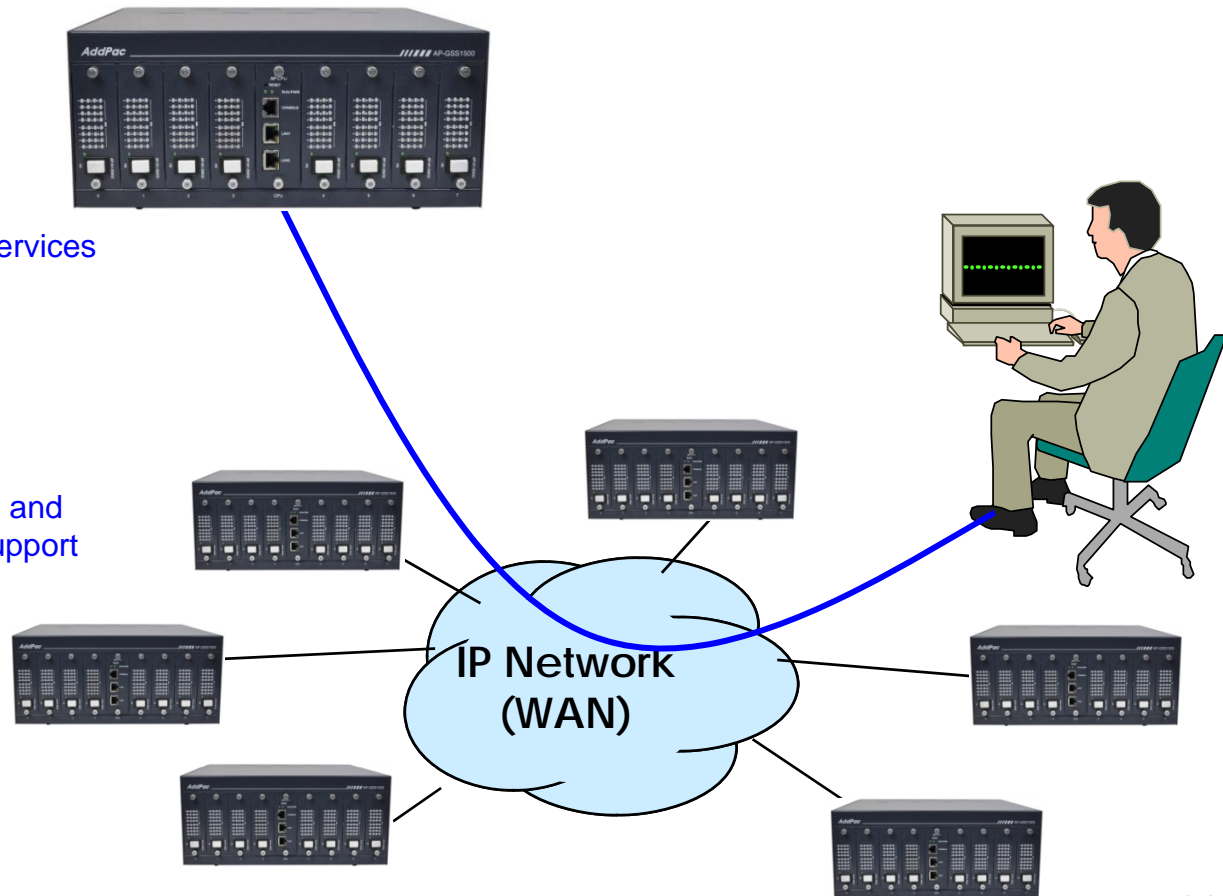

Security Management

AP-GSS1500 GSM SIM Server

- IP packet filtering
- IP access list
- User authentication function
 - Password Authentication Protocol (PAP)
 - Challenge Handshake Authentication Protocol (CHAP)
- Enable/Disable specific protocols
- Auto-square connect of Telnet session
- Account Management function for multi-level user
- SNMP/TELNET/FTP/HTTP/TFTP port assignment function
- SNMP/TELNET/FTP access list management
- Boot mode security checking function

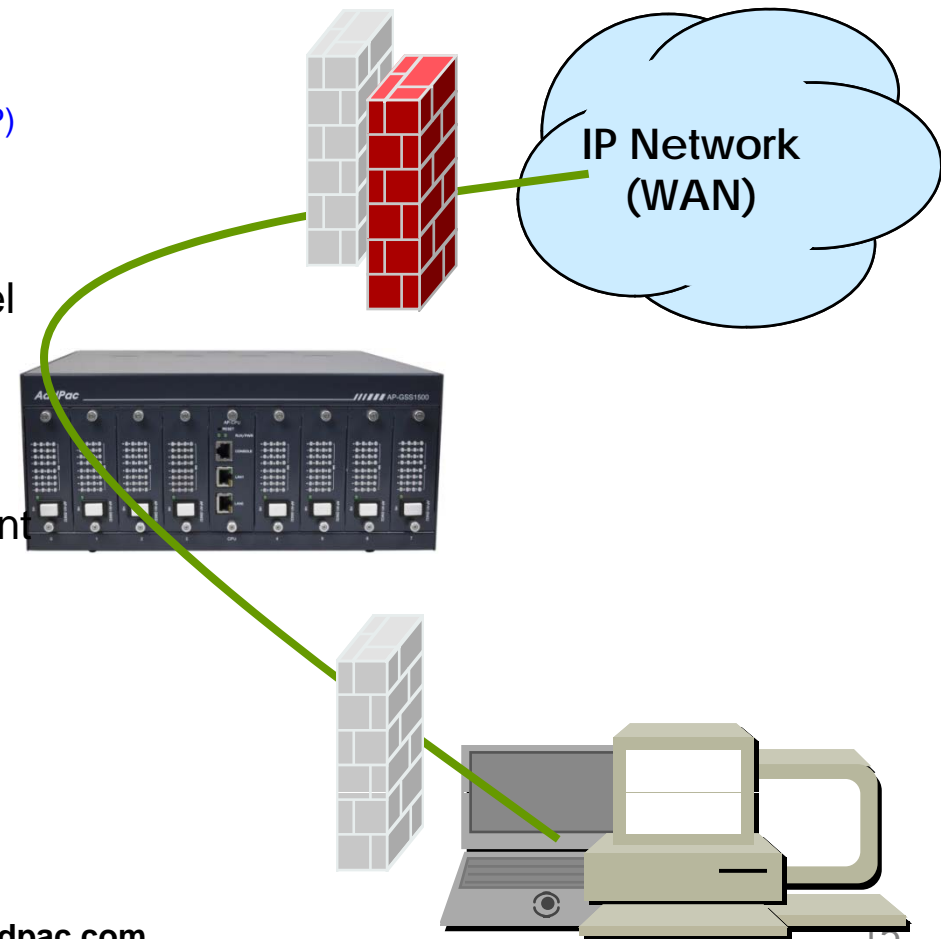

Smart Web Manager for SIM Server

AP-GSS1500 GSM SIM Server

Smart SIM Server Manager
www.addpac.com

Home
Configuration
Monitoring
System

Getting Started GO

Linked in
facebook
YouTube

Welcome to AddPac SIM Server

User : Admin.
Last Login at April 17 11:12PM (172.16.3.3)

Quick Menu
Gateway Summary
Gateway Port
SIM Card
USSD Service

Unread Alarm Message 3

- 2012-04-12 05:00pm admin login failed.
- 2012-04-12 05:05pm DDOS attached from....
- 2012-04-12 09:00pm DDOS attached from....

SIM Server Array

SIM Client

AP-GSS5000	Total	Inserted	Registered	Unregistered	Blocked
AP-GSS5000	256	226	200	21	5
AP-GSS5000	256	226	200	21	5
AP-GSS5000	256	226	200	21	5

Gateway	Configured	Registered	Unregistered
Gateway	20	18	2
Total	In Service	Out of service	
Ports	512	500	12

Gateway	Total	OK	Not OK
Gateway #1	32	30	2
Gateway #2	32	30	2
Gateway #3	32	30	2
Gateway #4	32	30	2
Gateway #5	32	30	2
Gateway #6	32	30	2
Gateway #7	32	30	2
Gateway #8	32	30	2

Slot	0	1	2	3	4	5	6	7
Registered	15	15	14	13	15	15	12	14
Unregisterd	1	1	2	3	1	1	4	2
Blocked	1	0	2	6	1	5	1	4

Slot	8	9	10	11	12	13	14	15
Registered	15	15	14	13	15	15	12	14
Unregisterd	1	1	2	3	1	1	4	2
Blocked	1	0	2	6	1	5	1	4

Copyright © AddPac 1999-2012 All Rights Reserved

Standard Application

AP-GSS1500 GSM SIM Server

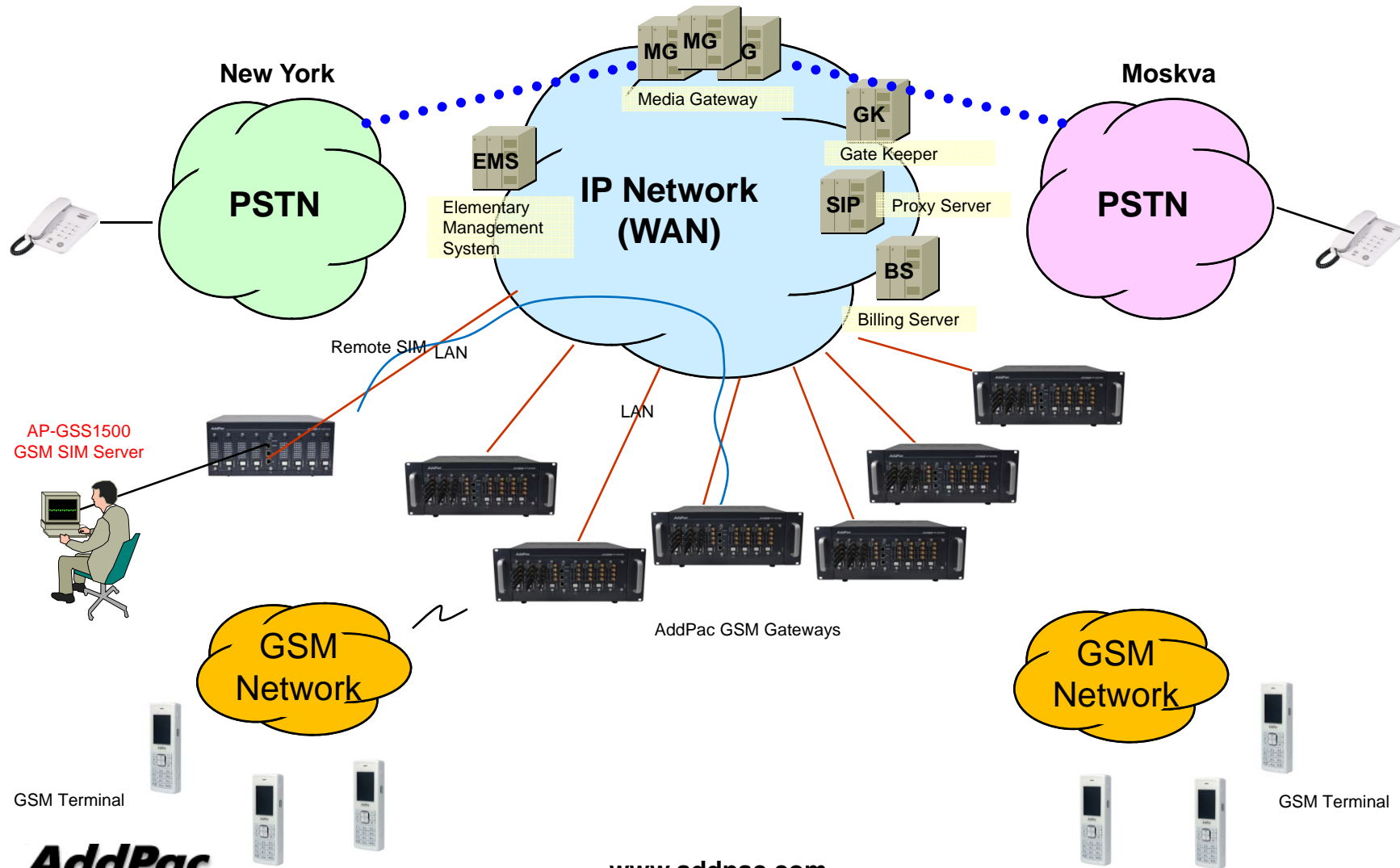

Ordering Information

- AP-GSS1500 GSM SIM Server Hardware
 - AP-GSS1500 GSM Gateway Main Body
 - Octal(8) Module Slots excluding CPU Module
 - High-end Programmable RISC Microprocessor
 - 2-port 10/100/1000Mbps Gigabit Ethernet(RJ45)
 - 1-Port RS232C Console Interface(RJ45)
 - Option Module : AP-N1-SIM32 GSM SIM Bank Module
 - Including Network Cable, Antenna, etc.
- Built-in APOS Internetworking Software for AP-GSS1500
- Including 1 Year Hardware Warranty
- Product Documents
 - Install and Operation Guide (PDF)
- Pricing
 - AddPac Technology Regional Sales Manager
 - Authorized Sales and Marketing Representatives
 - Please Contact www.addpac.com

GSM SIM Server Series

Thank you!

AddPac Technology Co., Ltd.
Sales and Marketing

Phone +82.2.568.3848 (KOREA)

FAX +82.2.568.3847 (KOREA)

E-mail sales@addpac.com