

AP-AC20 IP Voice Door Phone



Relay Output Port Control Scheme

AddPac

AddPac Technology

Sales and Marketing

Contents

- Relay Output Port Example
- Relay Output Port Type (Form C)
- Emergency Door Control Service Diagram
- Signal Flow



Relay Output Port (example)

Back Side

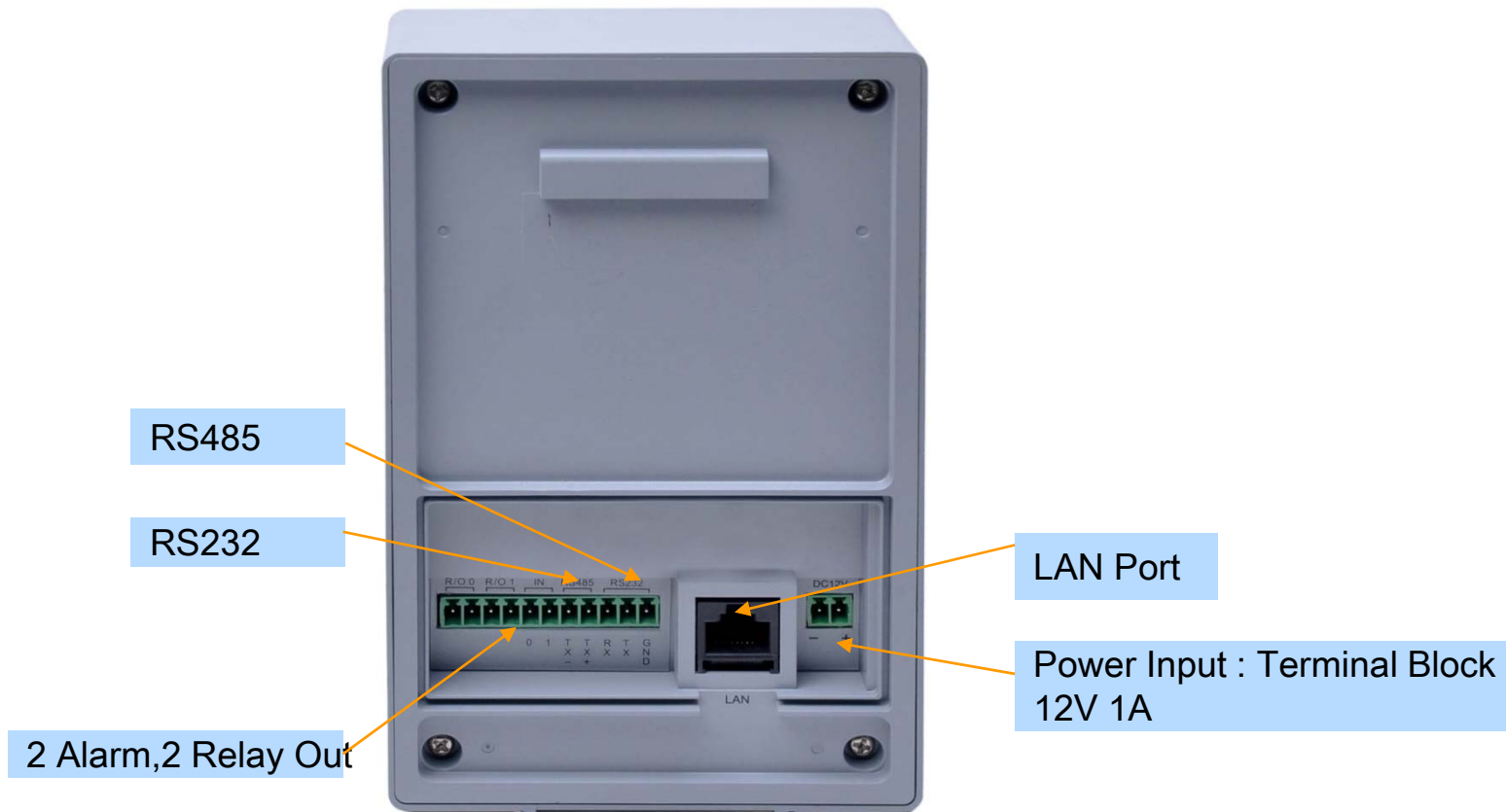

Relay Output Port Type (Form C type)

Relay Output Port Type



Form A

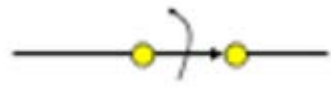

Form B

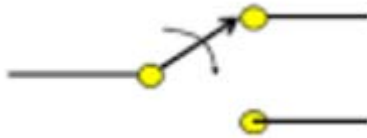

Form C/D

Contact Operation	Open	During Operation	Operation Complete
Form C			
Form D			

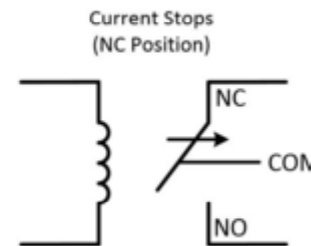
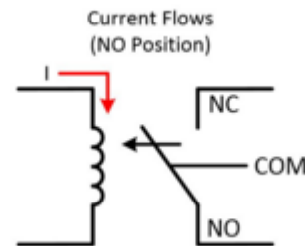
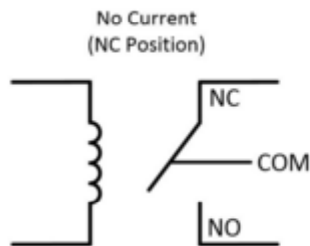

NC : Normal Close
NO : Normal Open
COM : Common

Relay Output Port Type (Form C type)

No Power Contact Relay Output Port

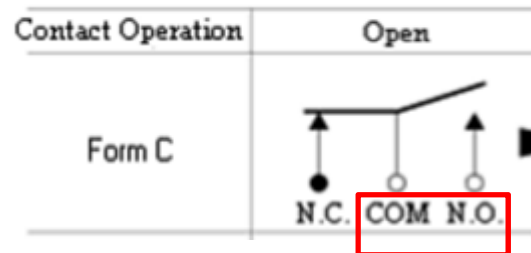

VAC200, VAC50, etc. Relay Output Port

Emergency Door Control Service Diagram

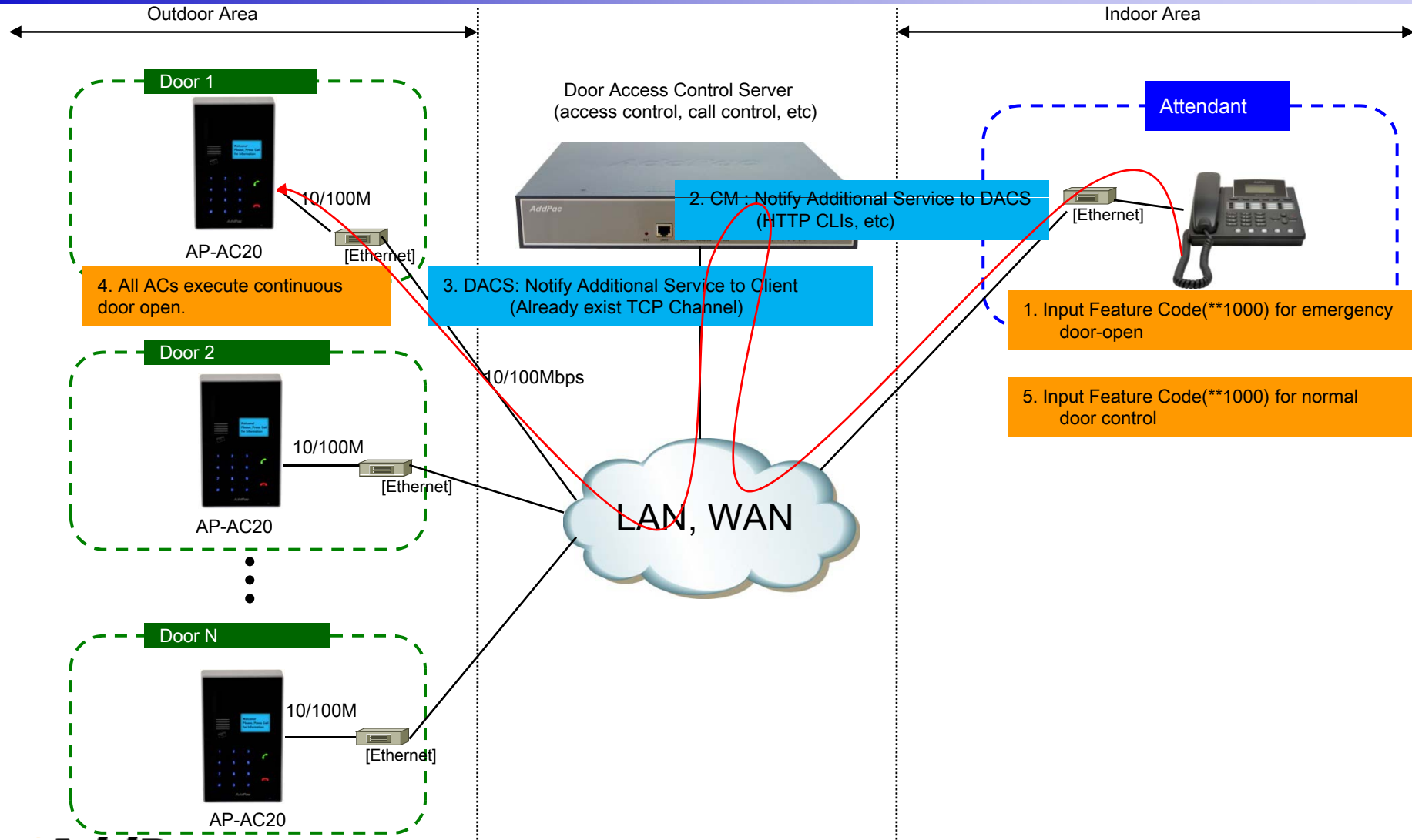

Signal Flow for Emergency Door Control

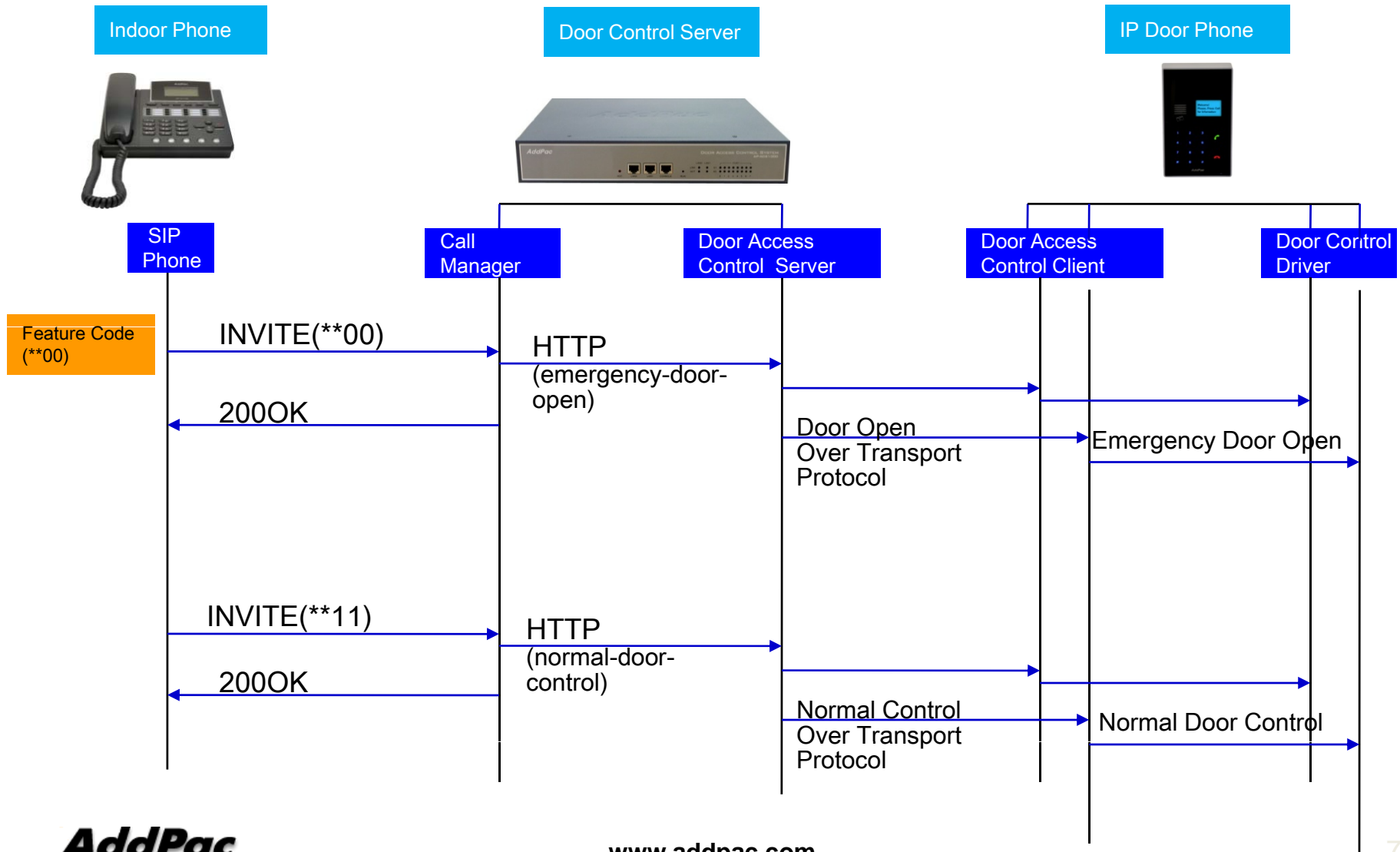



Thank you!

AddPac Technology Co., Ltd.
Sales and Marketing

Phone +82.2.568.3848 (KOREA)

FAX +82.2.568.3847 (KOREA)

E-mail sales@addpac.com