



AP-CD916™

16-Port CDMA VoIP Gateway

High Performance CDMA VoIP Gateway Solution

Preliminary Product Overview

(Without notice, following described technical spec. can be changed)



AddPac

AddPac Technology

2012, Sales and Marketing

www.addpac.com

Contents

- Product Overview
- Hardware Specification
- APOS Technology
- CDMA Module Specification
- VoIP (Voice over IP) service
- Advanced QoS Features
- Network Protocols
- Network Management
- Smart Web Management
- Security Management
- Application Service
- Ordering Information

Product Overview

AP-CD916 16-Port CDMA VoIP Gateway

- 16-Port CDMA VoIP Gateway Solution
- Four(4) Module Slots for 4-Port CDMA Module
- CDMA VoIP Interface(LAN) Support
- H.323/SIP Dual Concurrent Stack Embedded
- High Performance RISC & Programmable DSP Architecture
- G.711/G.726/G.723/G.729, T.38 Fax , VAD, etc
- Powerful Network Protocols (PPPoE, DHCP, Static Routing, etc)
- Two(2) 10/100Mbps Fast Ethernet (IP Share ,etc)
- One(1) RS-232C Port for Command Line Interface
- Firmware Upgradeable Architecture
- VPMS (VoIP Plug&Play Management System) for Large Scale Deployment
- Advanced Voice QoS Mechanism
- Light and Compact Design with Internal Power Supply

Product Highlights

AP-CD916 16-Port CDMA VoIP Gateway

**High Performance CDMA VoIP Gateway
Up to 16-Port CDMA Interface**

**State-of-art Signaling
H.323, SIP
Concurrent Dual Stack**

**Four(4) Module Slots
4-Port CDMA Module**

**Advanced Smart Web
Manager Support**

**High Performance RISC CPU
+ Programmable DSP**

**Excellent Voice Quality
G.729/G.723/G726/G711**

**Broadband IP Networking
With two(2) 10/100Mbps
Fast Ethernet**

**APOS™Technology
Firmware Upgradeable Architecture**

**Smart NMS(Network Management
System) Support**

**Powerful Network Protocol
Support**

**Powerful Trouble Shooting &
Debugging Feature Support**

**Advanced Voice
Traffic QoS Mechanism**

AddPac

www.addpac.com

APOS Technology

AP-CD916 16-Port CDMA VoIP Gateway

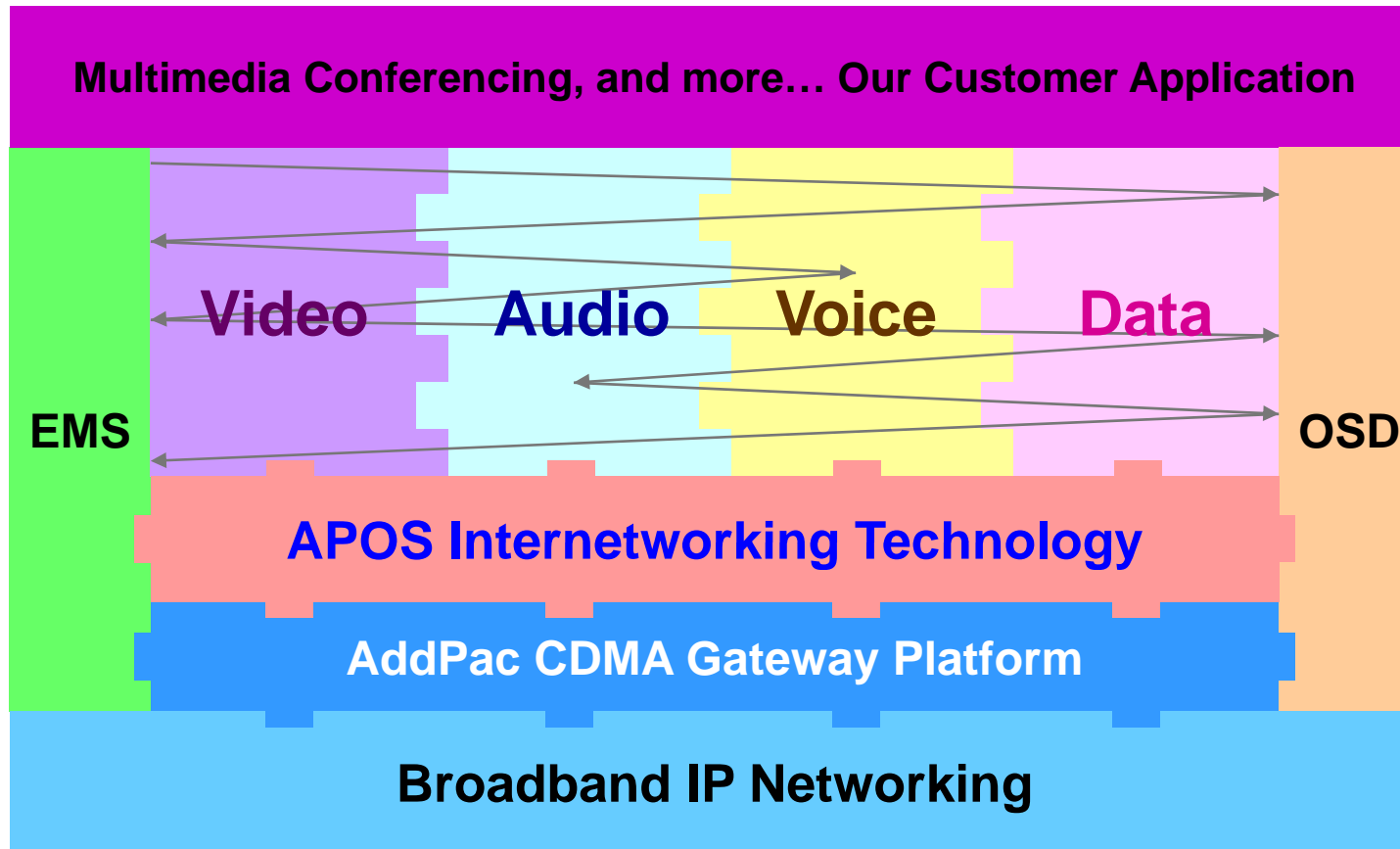

- APOS : AddPac Internetworking Operating System
- OSD : On- Screen Display
- EMS : Element Management System

Hardware Specification

AP-CD916 16-Port CDMA VoIP Gateway

RISC
CPU

High-end
DSP

- RISC Microprocessor Computing Power
- Powerful High-End DSP for VoIP Interface
- Four(4) Module Slot for CDMA VoIP Interface
- 4-Port CDMA Module(Ex: AP-N1-CDMA4I)
 - 4-Port RUIM Card Slot
 - 4-Port Antenna Interface
 - Hot-Swap
- Network Interface for VoIP Direct Interface
 - Two(2) 10/100Mbps Fast Ethernet (RJ45)
- RS232C Console Interface for CLI
- Run LED, LAN LED, Port LEDs at Front Side
- Compact and Light Design with Internal Power Supply

Hardware Specification

AP-CD916 16-Port CDMA VoIP Gateway

RISC
CPU

High-end
DSP

AP-CD916 CDMA VoIP Gateway	Basic Specifications
CDMA VoIP Interface Slots	Four(4) Module Slot for CDMA Interface
CDMA VoIP Modules	AP-N1-CDMA4, AP-N1-CDMA4I
Ethernet Interface	Two(2) 10/100Mbps Fast Ethernet (RJ-45)
Console Interface	One(1) RS-232C Interface for CLI (RJ45)
Flash Memory	512Mbyte High-speed Flash Memory
Main Memory	128Mbyte High-speed SDRAM
Power Requirement	Power Supply Adaptor / VAC 110~220V, 50/60Hz, 5V 20A
Operating Temperature	0°C ~ 45°C (32 °F ~ 122°F)
Storage Temperature	-40°C ~ 85°C (-40°C ~ 185°F)
Relative Humidity	5% ~ 95% (Non-condensing)
Dimension (H x W x D)	56mm x 440mm x 313mm - 19" Rack Mountable Chassis
Weight	4.9Kg

Hardware Specification

AP-CD916 16-Port CDMA VoIP Gateway

RISC
CPU

High-end
DSP

Front Side View

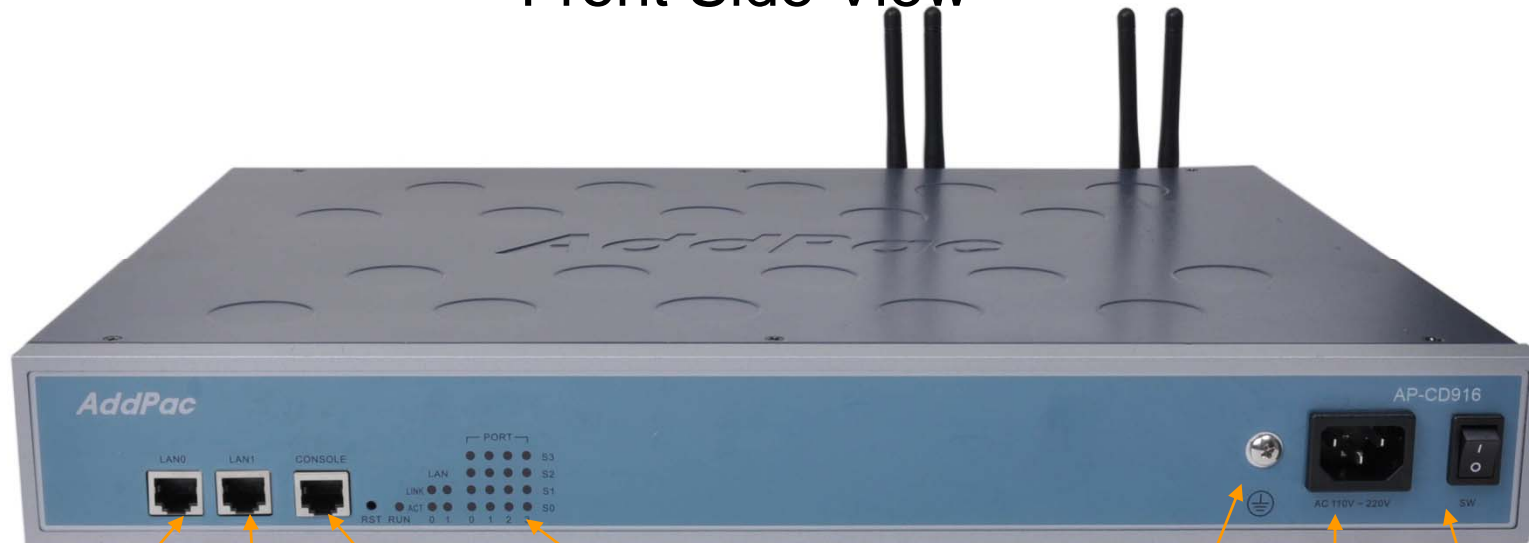

LAN0 10/100Mbps
Ethernet

LAN1 10/100Mbps
Ethernet

RS232C
Console Port

Port LEDs

GND

Power Input

Power Switch

Hardware Specification

AP-CD916 16-Port CDMA VoIP Gateway

RISC
CPU

High-end
DSP

Back Side View



CDMA
Antenna

RUM Card
Slot

CDMA VoIP Modules

AP-CD916 16-Port CDMA VoIP Gateway

RISC
CPU

High-end
DSP

AP-N1-CDMA4I 4-Port GSM Module



AP-N1-CDMA4 4-Port GSM Module



Hardware Specification

AP-CD916 16-Port CDMA VoIP Gateway

RISC
CPU

High-end
DSP

CDMA VoIP Gateway Service Diagram

AP-CD916 Internal H/W Block Diagram

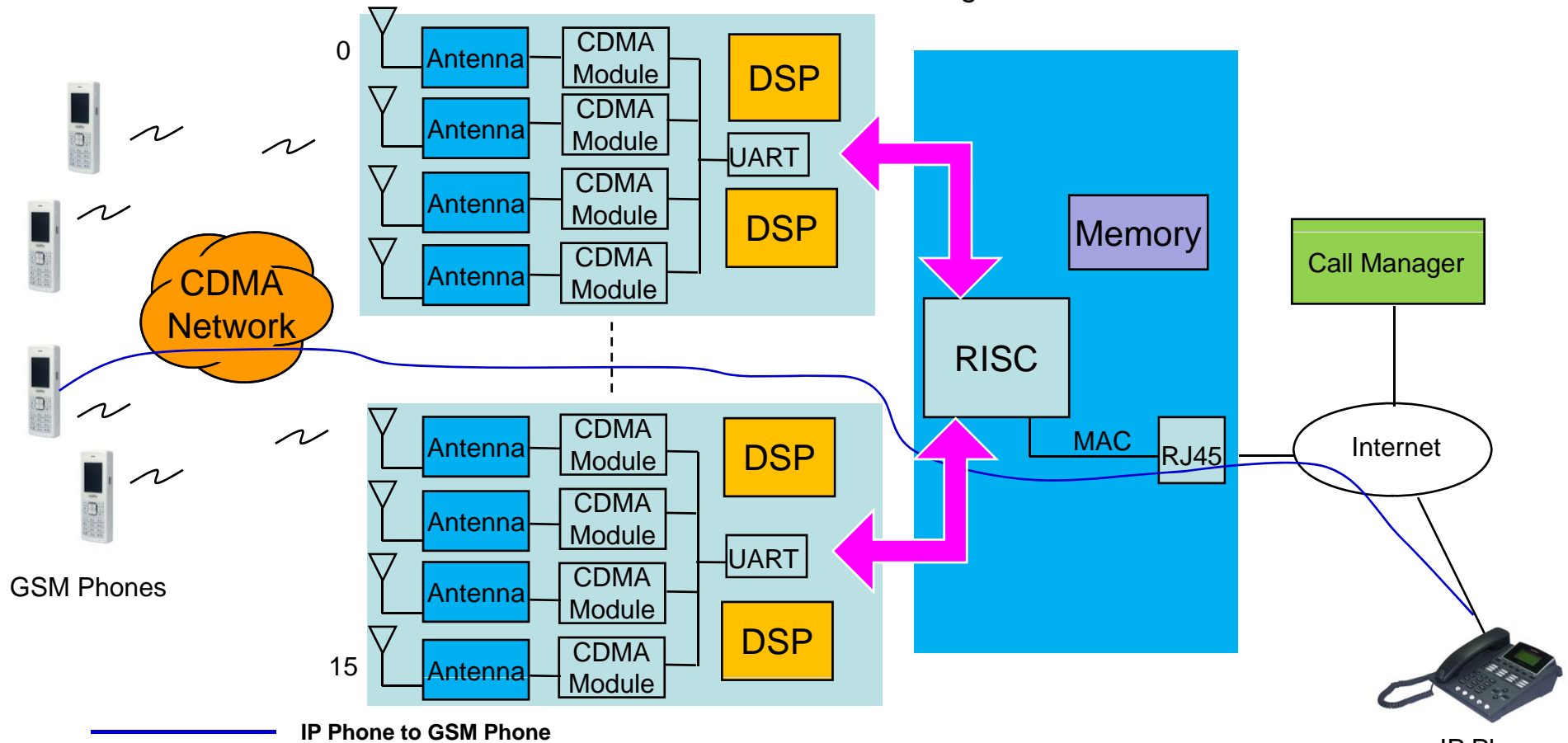

CDMA Module Specification

AP-CD916 16-Port CDMA VoIP Gateway

- CDMA2000 1xRTT (IS-2000)-(Dual Band)
- Band class0 (TX : 824~849 MHz / RX : 869~894MHz)
- Band class1 (TX : 1850~1910 MHz / RX : 1930~1990MHz)
- GPS L1 Support
- Output Power : 0.25W CDMA
- CDMA2000 Release A
- IS-637 : Short Message Service (Mobile Originated and Mobile Terminated)
- RUIM(for Asia Pacific Countries)

VoIP (Voice over IP) Service

AP-CD916 16-Port CDMA VoIP Gateway

- H.323, SIP Dual Stack
- H.323
 - ITU-T Standard H.323 v3 Support
 - Support H.245 Tunneling
 - Including H.235 Security Features
- SIP
 - IETF RFC3261 or RFC2543 SIP Standard

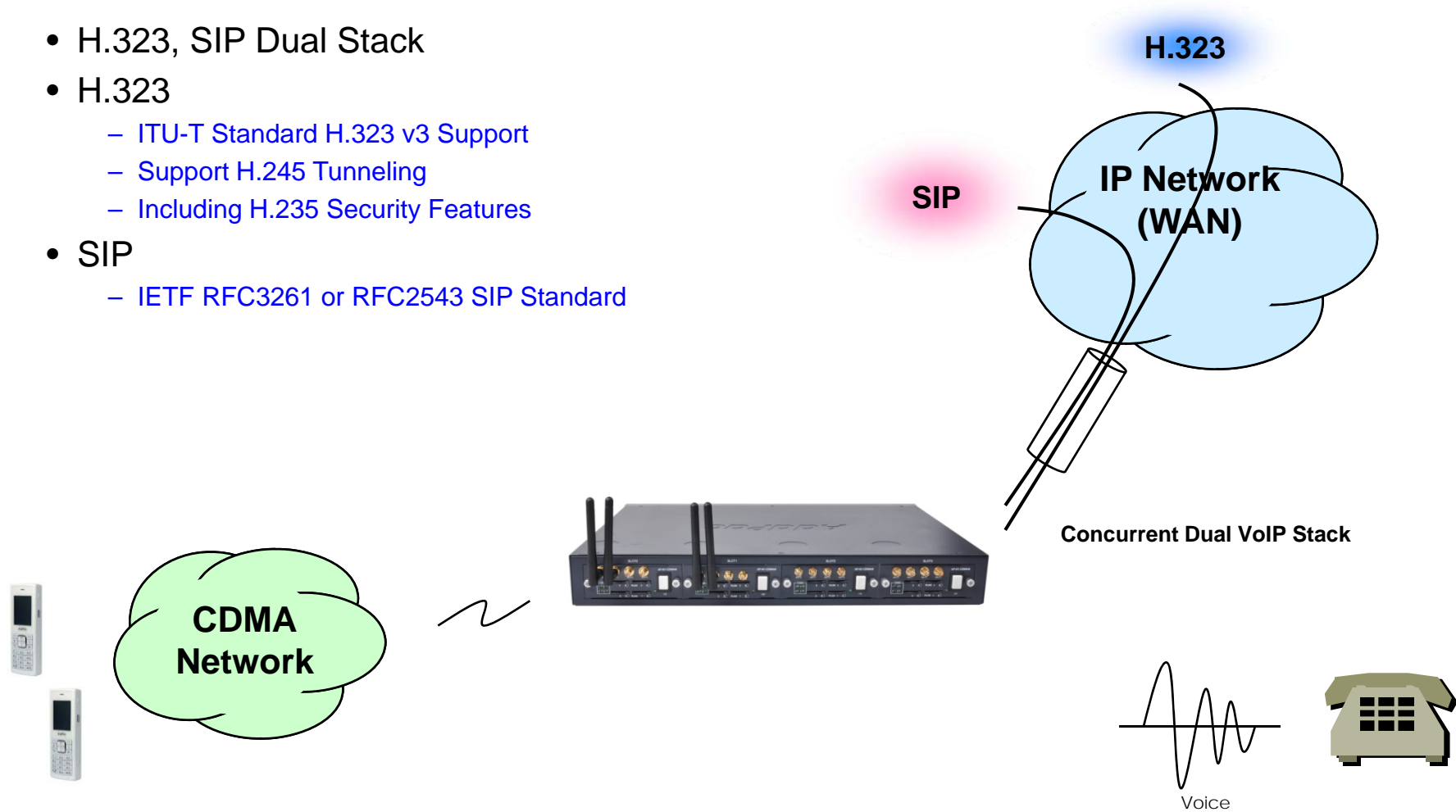

VoIP (Voice over IP) Service

AP-CD916 16-Port CDMA VoIP Gateway

- H.323

- Fast connect, normal connect support
- H.245 tunneling support
- Q.931 response message setting for inbound VoIP calls
- H.245 logical channel open timing selection function
- Start H.245 procedure support
- DTMF / Hook flash relay with H.245 alphanumeric / signal
- Secondary gatekeeper support
- Gatekeeper assignment according to the domain name
- Gatekeeper discovery with multicast
- Lightweight RRQ support
- Signaling TCP port assignment
- Resource threshold setting with RAI
- H.235 clear-token, crypto-token support
- canMapAlias support
- Technical prefix (supported prefix) support
- Public IP assignment in NAT environment

- SIP

- Gateway-based / Endpoint-based registration support
- Secondary proxy-server assignment function
- SIP signaling port change function
- SIP proxy server assignment according to the domain name
- T.38 real-time fax relay support
- DTMF relay support with RFC2833 / OPTION message
- Re-INVITE support

VoIP (Voice over IP) Service

AP-CD916 16-Port CDMA VoIP Gateway

- Voice Codec

- G.711 A-Law, G.711 U-Law
- G.726 r16, G.726 r32
- G.729A
- G.723.1 r63, G.723.1 r53
- VAD (Voice Activity Detection) function support
- DTMF relay support (H.323, SIP, MGCP common) based on RFC2833

- RTP

- Redundant RTP packet transmission in case of severe packet loss
- Dynamic jitter buffer management and RPT packet jitter and loss compensation with heuristic & DSP error concealment
- Static jitter buffer setting support
- Voice frame per RTP packet number control for each codec
- In-band ring-back tone support
- Virtual ring-back tone support
- Tone parameter change support

- FAX

- Fax relay mode supporting T.38, inband-T.38, bypass mode
- Lost packet compensation with redundant setting in case of T.38 fax relay
- Fax relay mode, rate setting for remote end

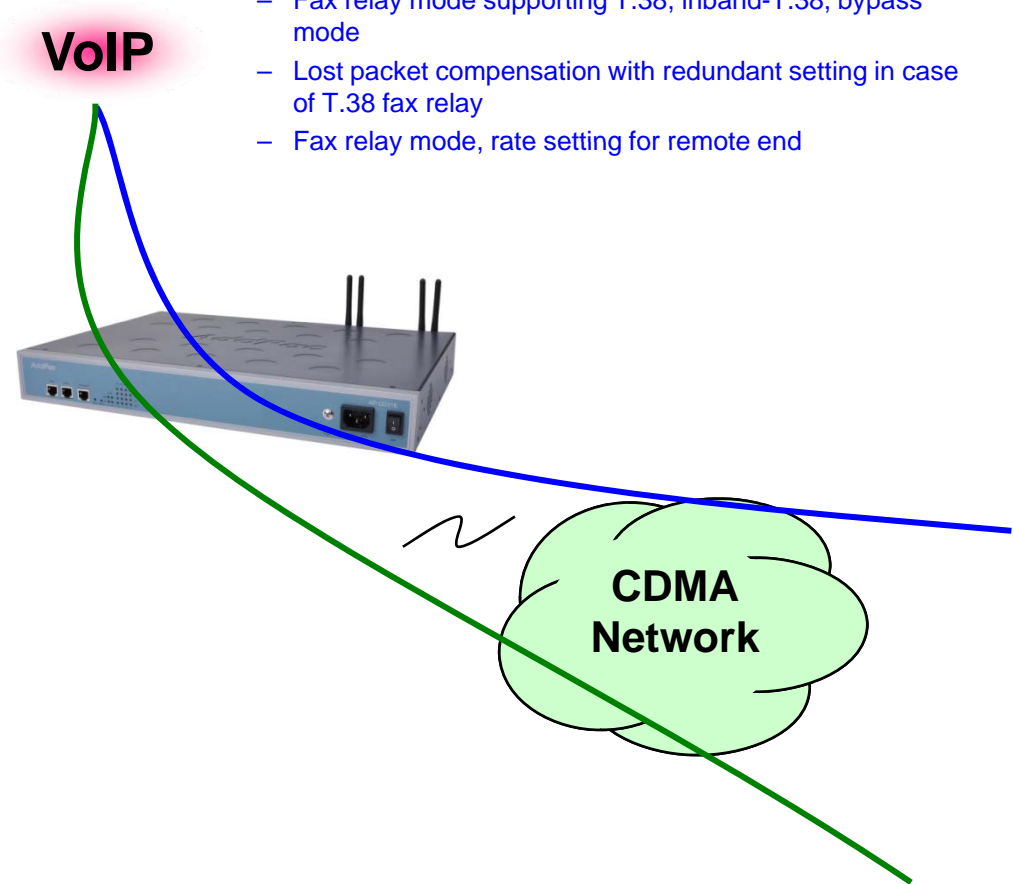

VoIP (Voice over IP) Service

AP-CD916 16-Port CDMA VoIP Gateway

- VoIP Call Controls

- Hot line connection function with PLAR (Private Line Auto Ring Down)
- Leased line emulation function
- Connection monitoring function
- Fault tolerant with Redundancy and Call Distribution among Gateways for load balancing
- Call attempt with IP address
- H.323, SIP, MGCP inbound call connection for each voice port
- Multiple E.164 setting for one voice port
- One E.164 or digit pattern can be assigned to more than one voice port
- Hunting with Longest match/ priority/ sequence/ random
- One stage call setup by Digit forwarding
- Call barring with specific digit patterns
- Calling and called number conversion for PSTN outbound calls
- PSTN rerouting in case of VoIP call attempt failure

- VoIP Call Controls (cont.)

- Call transfer for internal calls
- Call pickup for internal calls
- Calling and called number conversion for VoIP outbound calls
- Calling and called number conversion for VoIP inbound calls
- Fax broadcasting call control

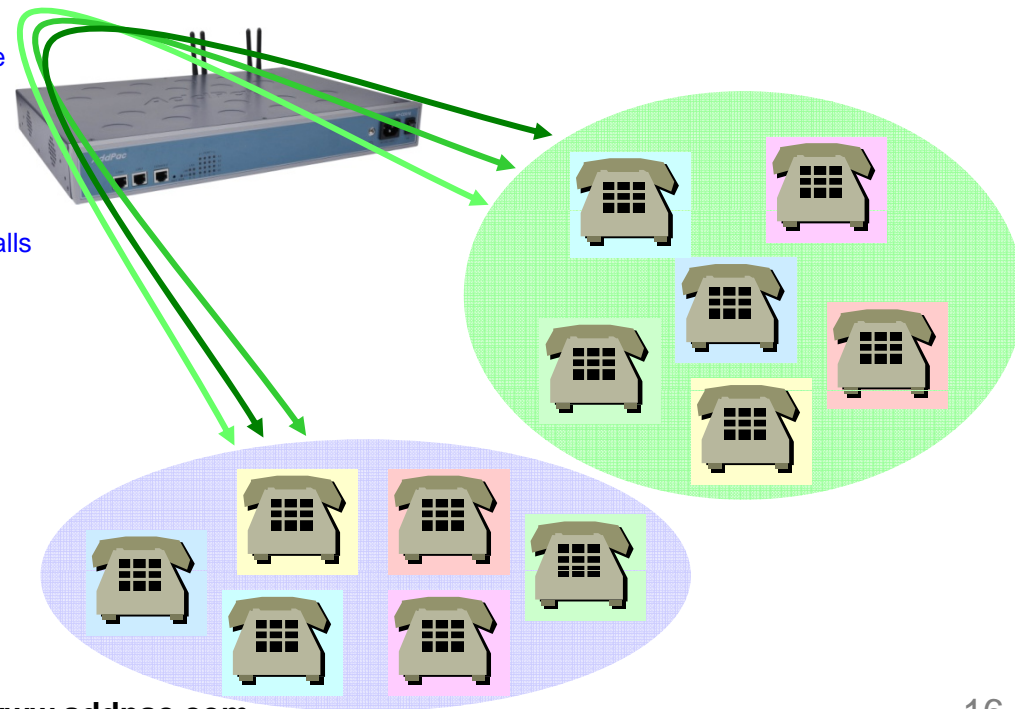

Advanced QoS Features

AP-CD916 16-Port CDMA VoIP Gateway

- Enhances **Transmit** Voice QoS Features

- Voice Traffic Priority Queuing
- QoS Service Profiling
- Providing Virtual Network Transmit Algorithm
- Real-time Voice Traffic QoS Support
- RTP Packet Transmit Interval Control
- Supporting RTP Packet Redundancy Scheme
- IP Header Control such as ToS, Diffserv

- Enhances **Receive** Voice QoS Features

- Dynamic Jitter Buffer Management
- Error Concealment
- Support T.38 FAX Data Error Recovery Scheme

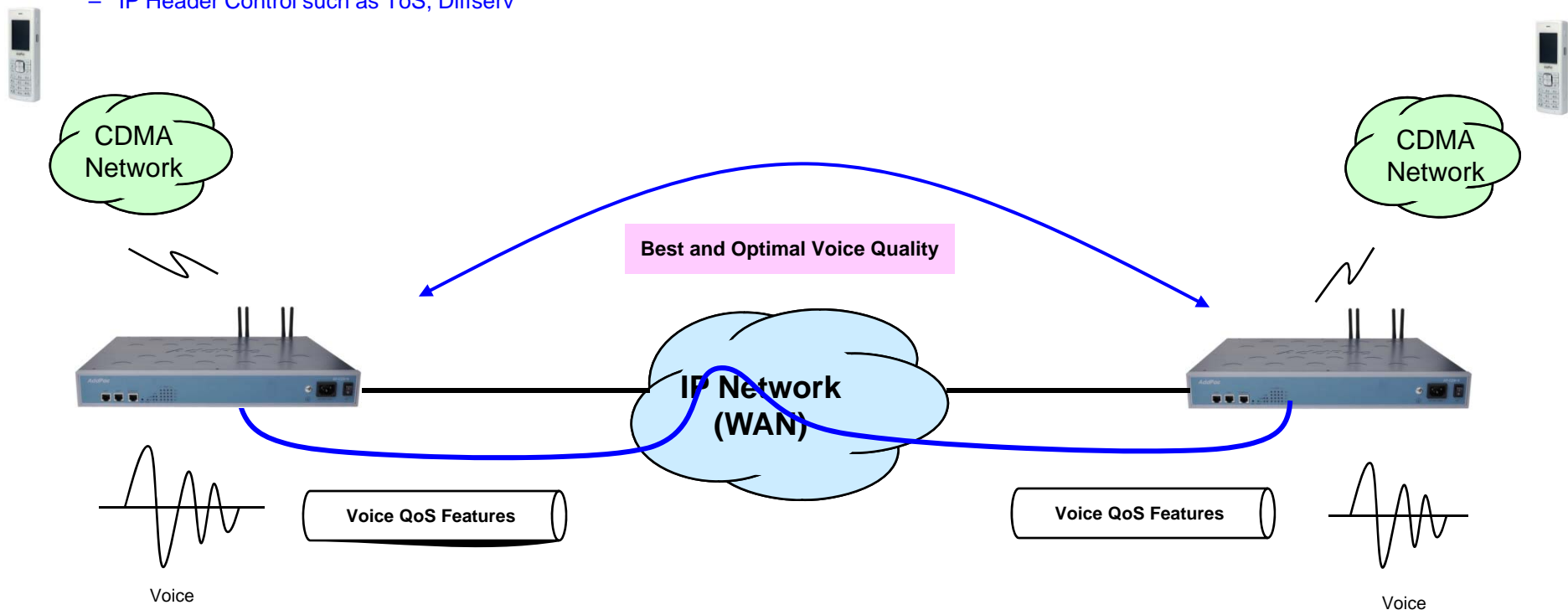

Network Protocols

AP-CD916 16-Port CDMA VoIP Gateway

- **Basic Network Protocols**
 - ARP, IPv4, TCP, UDP, ICMP, SCTP, IGMP, MLD
- **Routing Protocol**
 - IPv4 : Static
- **Service Protocol**
 - FTP, Telnet, TFTP, DHCP Server/Relay, SNMP Server
 - CDP (Cisco Discovery Protocol)
 - DNS Resolver, DDNS(nsupdate)
 - Bridge
 - Syslog
- **IPv4 Address Configuration**
 - Fixed (Static)
 - DHCP
 - PPPoE
- **Miscellaneous**
 - Cisco Style CLI
 - Standard & Extended IPv4 Access List
 - Multi-level User Account Management
 - IP accounting
 - STUN Client

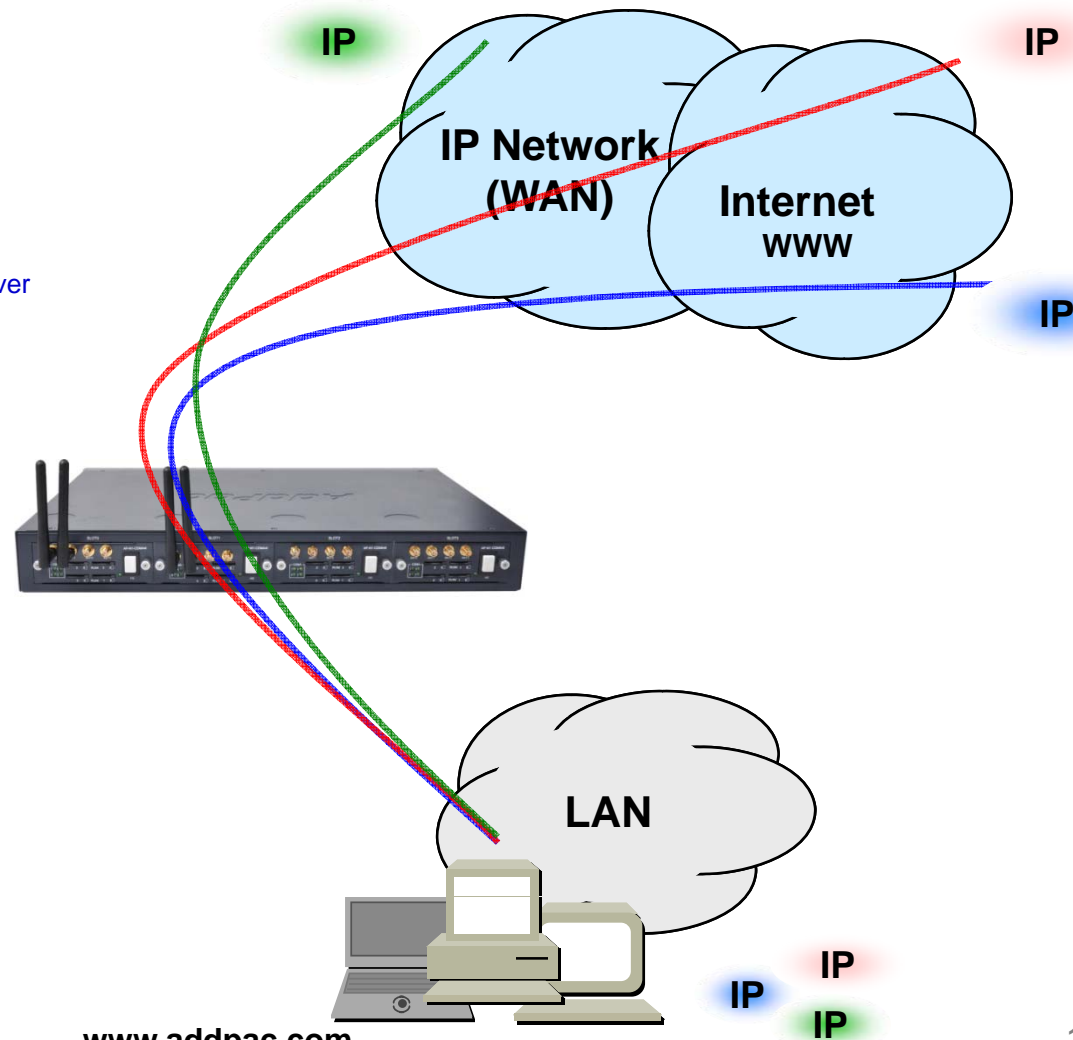

Network Management

AP-CD916 16-Port CDMA VoIP Gateway

- **SNMP**
 - Standard Simple Network Management Protocol(SNMP) Agent support
 - MIB v1 and v2 Support
- **Web-based Management**
 - Smart Easy Setup
 - Standard Voice Interface
 - Standard PSTN Back-up Interface
- **Watch-dog Function**
 - Hardware, Software watch-dog services
- **Remote Management**
 - Telnet
 - Rlogin
- **Auto Upgrade Service**
 - HTTP server based APOS image and configuration file auto upgrade support
- **Batch Job Function**
 - Text based script downloading
- **Interoperable with AP-VPMS Service**
 - AddPac VoIP Plug & Play Management System (AP-VPMS)

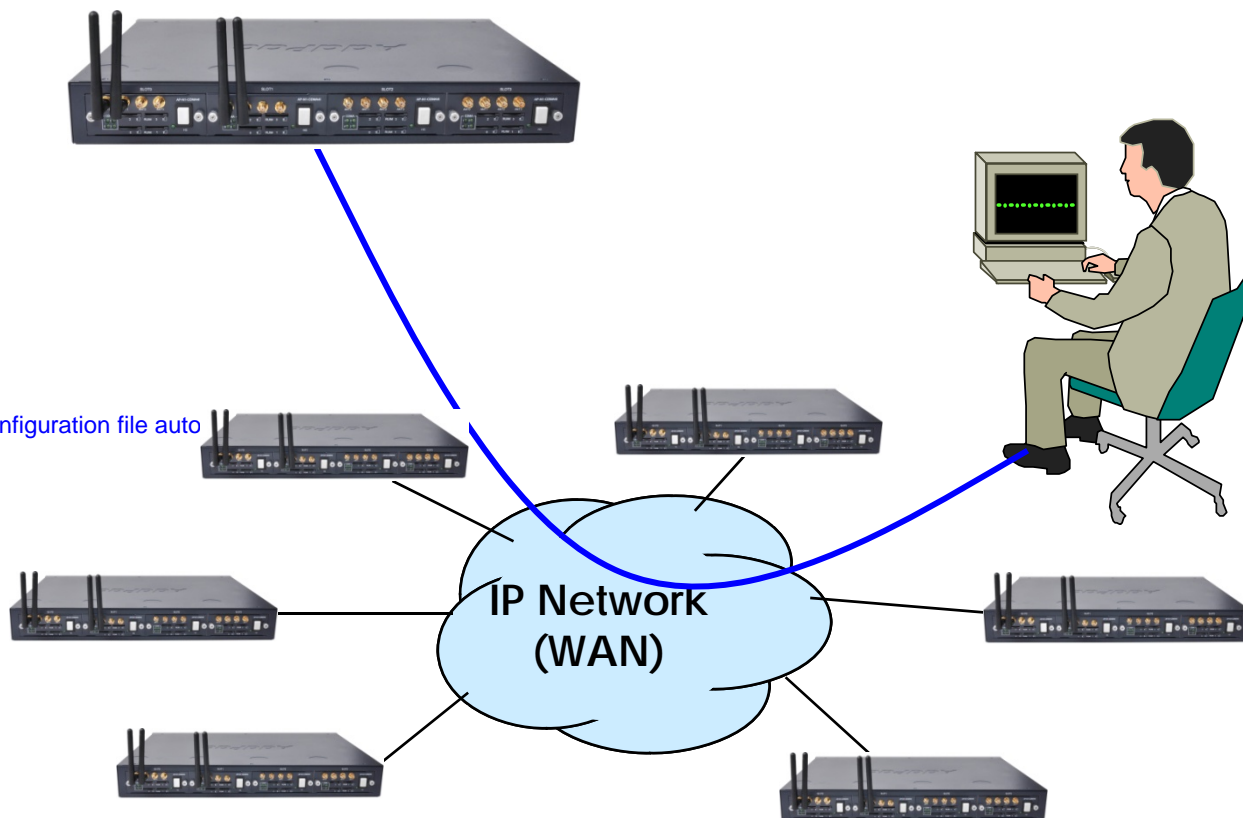

Smart Web Manager : Main Page Layout

AP-CD916 16-Port CDMA VoIP Gateway

Main Menu
For easy system setup, provide the various menu and category

- System
 - Network Setup
 - Language
 - NTP
 - Backup/Restore
- Basic
 - Protocol
 - Server SIP
 - Server H.323
 - Tel Number
 - FXS/FXO/E1 Group
 - E1 Trunk
 - DTMF/CODEC
 - Dial Plan/Prefix
 - Static Route
 - Hot Line
- Advanced
 - Gain
 - Fax
 - Service
 - Filtering
 - Security
 - SNMP
- Miscellaneous
 - Call Status
 - System Status
 - Alarm Status
 - Call Log
 - System Log
 - Test Call
 - Ping

Tool Bar
Provide frequently used tools like as System Update, Configuration Backup, Initialization, Restart, Telnet

System Information

HW Version	2.0
S/W Version	ap1800k_web_g2_v8_47T.bin 8.47
MAC Address	0002.a511.2245
VoIP Protocol	SIP
Voice Interface Module	S(4)O(4) : E1(2)
Registration Status	Unregistered
Supported Codec List	g711alaw g711ulaw g7231r53 g7231r63 g726r32 g729
Network Information	Static 172.16.50.114
WAN LINK Status	100Mbps FULL Duplex Link UP
LAN LINK Status	Link Down
Current Time	Thu Oct 1 13:06:23 2009
System Startup Time	Thu Oct 1 12:56:46 2009
System Running Time	0 days 00:09:37
Total Calls	0

Information
Display the current system version and status summary

Information

AddPac Tehonology
Model : AP1800K_G2
HW Version : 2.0
S/W Version : 8.47
Smart Web Version : 0.3
Smart Web Build : Oct 1 2009
Voice Interface
S(4)O(4) : E1(2)
Protocol : SIP
Status : Unregistered
CurrentCalls : 0 Call
Network : Static 172.16.50.114
Mac Address: 0002.a511.2245

Description

WAN 포트에 대한 설정입니다. Static IP의 경우 고정 IP 주소로 사업자로 부터 할당 받은 주소 정보를 입력합니다. DHCP와 PPPoE의 경우 유동 IP로 장비의 주소가 변경될 수 있습니다. DHCP 및 PPPoE는 사용자 환경에 맞도록 설정하십시오. MAC 주소 변경은 필요시 장비에 설정된 주소를 사용하지 않고사용자가 설정한 주소를 사용하는 방안으로 반드시 필요한 경우에 한하여 사용하여야 합니다.

Workspace
Workspace for detailed action

Description
Display the help message if you move mouse over main menu

©AddPac Tehonology 2008-2009. all rights reserved.

Smart Web Manager : SIP Server (Example)

AP-CD916 16-Port CDMA VoIP Gateway

Smart Web Manager
www.addpac.com

SIP (Session Initiation Protocol)

Use SIP Server Yes No

Primary SIP Server Server address (IP or Domain Name) and Port (default 5060)

Secondary SIP Server Server address (IP or Domain Name) and Port (default 5060)

Local Domain name (SIP userpart of authentication)

SIP Signaling Port (default 5060, between 1 to 65535)

Register Expiration (in seconds, default 60, between 10 to 86400)

Session Re-Fresh INVITE UPDATE

Session Expire Time (in seconds, default 1800, between 30 to 86400, 0 = disable)

Apply

SIP Server
Primary & Secondary server,
Local domain name,
SIP Signaling Port (**reboot necessary**)
Timer
* register expire
* session refresh
* session expire

Information
AddPac Technology
Model : GS1002_G2
H/W Version : 2.0
S/W Version : 8.00d
Smart Web Version : 0.4
Smart Web Build : Mar 24 2010
Voice Interface
G(2)S(2)
Protocol : SIP
Status : Unregistered
CurrentCalls : 0 Call
Network : Static 172.16.9.16
Mac Address : 0002.a400.0000
Unread Message:
P0:0(0)
P0:1(0)

Description
Configure the settings for SIP.
Contact your service provider
for the settings

Security Management

AP-CD916 16-Port CDMA VoIP Gateway

- IP packet filtering
- IP access list
- User authentication function
 - Password Authentication Protocol (PAP)
 - Challenge Handshake Authentication Protocol (CHAP)
- Enable/Disable specific protocols
- Auto-square connect of Telnet session
- Account Management function for multi-level user
- SNMP/TELNET/FTP/HTTP/TFTP port assignment function
- SNMP/TELNET/FTP access list management
- Boot mode security checking function

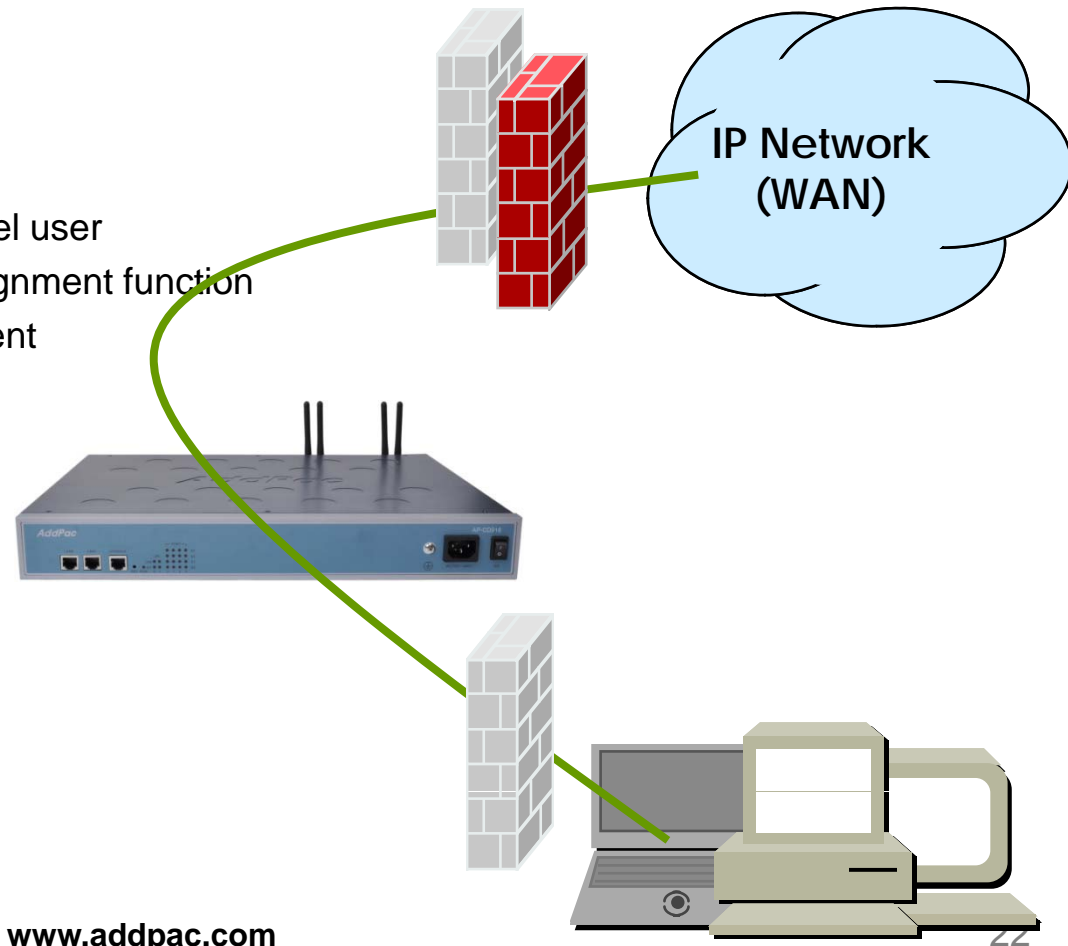

Standard Application

AP-CD916 16-Port CDMA VoIP Gateway

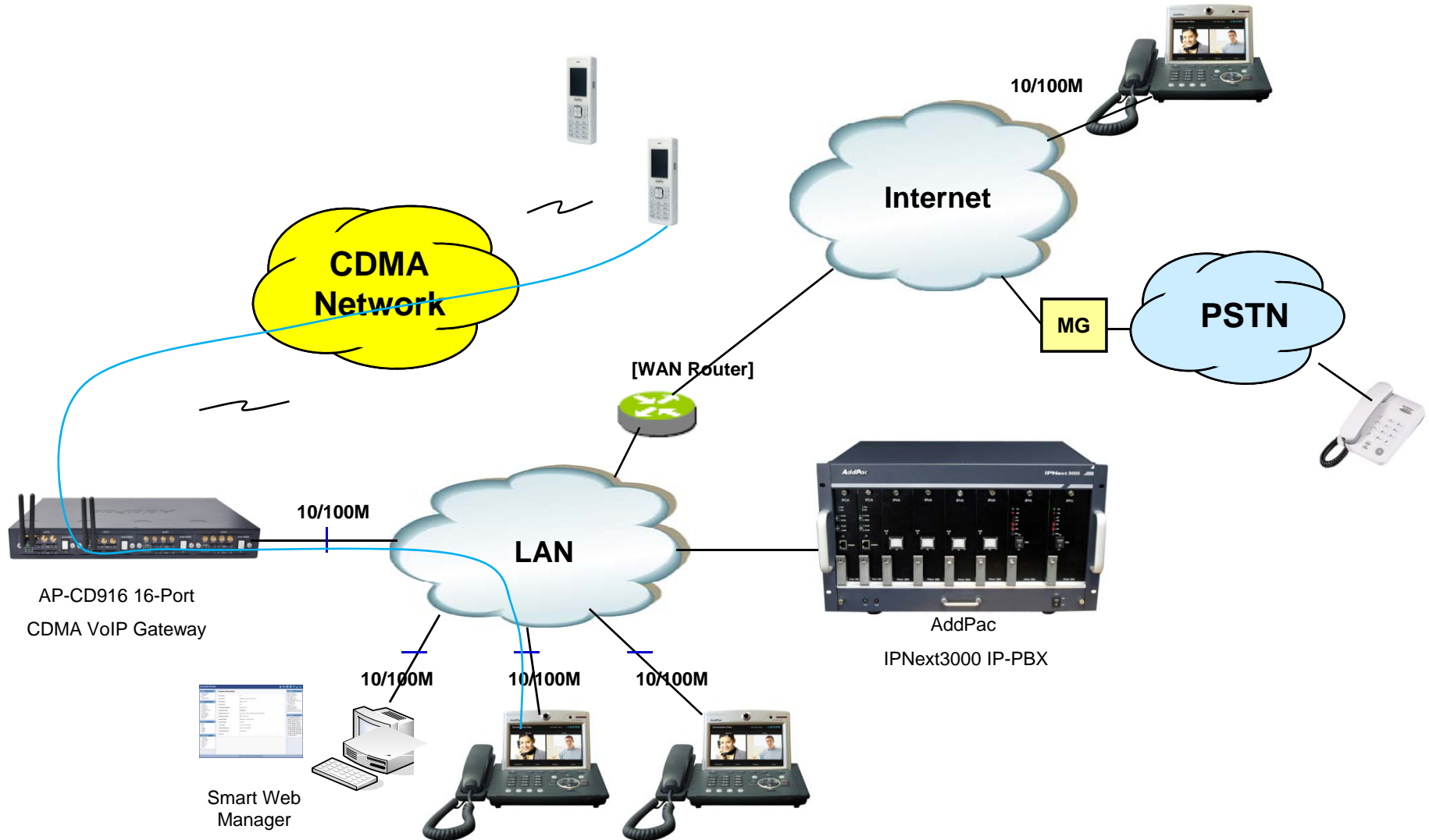

AddPac

www.addpac.com

Ordering Information

- **AP-CD916 CDMA Gateway Hardware**
 - AP-CD916 CDMA VoIP Gateway Main Body
 - RISC Microprocessor with High-end Programmable DSP Architecture
 - 2-port 10/100Mbps Fast Ethernet(RJ45)
 - 1-Port RS232C Console Interface(RJ45)
 - Including Network Cable, Antenna, etc.
- **Built-in APOS Internetworking Software for AP-CD916**
- **Including 1 Year Hardware Warranty**
- **Product Documents**
 - Install and Operation Guide (PDF)
- **Pricing**
 - AddPac Technology Regional Sales Manager
 - Authorized Sales and Marketing Representatives
 - Please Contact www.addpac.com

CDMA VoIP Gateway Series

Thank you!

AddPac Technology Co., Ltd.
Sales and Marketing

Phone +82.2.568.3848 (KOREA)

FAX +82.2.568.3847 (KOREA)

E-mail sales@addpac.com