



IPNext50™

Small, Powerful IP-PBX

Next Generation IP-PBX System for the Small Business and Home Office

New Models for GSM Interworking Service
(IPNext50 : Model G series)

Preliminary Product Overview



AddPac

AddPac Technology

2010, Sales and Marketing

www.addpac.com

Contents

- Product Overview
- APOS Technology
- Hardware Specification
- GSM Module Specification
- IP-PBX Features
- IP-PBX Advanced Features with AddPac IP, Video Phones
- VoIP Gateway Service Features
- RTP Proxy Function for Private IP solution
- Advanced QoS Features
- Network Protocols, Network & Security Management
- Smart Multimedia Manager (SMM)
- VPMS VoIP Management
- IP Multimedia Telephony Terminals
- Application Service
- Ordering Information

Product Overview

IPNext50 IP-PBX for GSM service

- SIP Application Server, Proxy, Registrar and Location Server
- Multiple ITSP Trunk with SIP & H.323 Accounts Support
- High Performance RISC & Programmable DSP Architecture
- Two(2) 10/100Mbps Fast Ethernet (IP Share ,etc)
- Up to Two(2) PSTN FXS VoIP Interface
- High Performance LAN-to-LAN Routing Capability
- VoIP Gateway : G.711/G.726/G.723/G.729, T.38 Fax , VAD, etc
- Powerful Network Protocols (PPPoE, DHCP, Static Routing, etc)
- IPv4/IPv6 Dual Stack
- RTP Proxy Function Embedded for Private IP and IPv6 Address Interworking
- Presence Service Features for Smart Multimedia Messenger and Smart IP Phone
- IVR Scenario Editor, Voice Mail, Third Party Conference (G.711)
- Firmware Upgradeable Architecture
- Smart Multimedia Manager for IP-PBX Management
- Smart Messenger Service for UC
- NMS(Network Management System) for Large Scale Deployment
- Advanced Voice QoS Mechanism
- Small, Light and Compact Design
- Power Switch for Stability and Status LEDs

Product Highlights

IPNext50 IP-PBX for GSM service

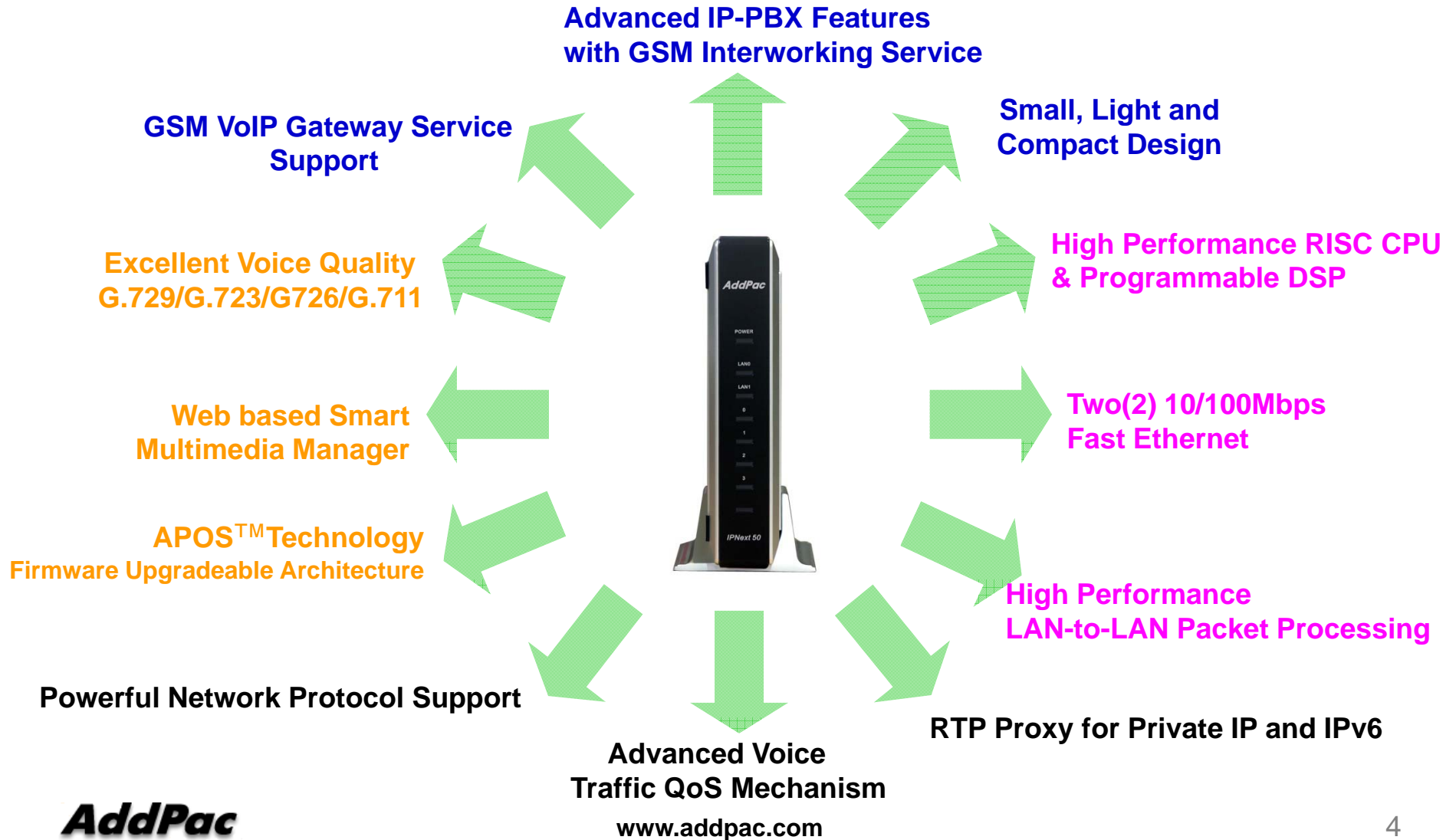

APOS Technology

IPNext50 IP-PBX for GSM service

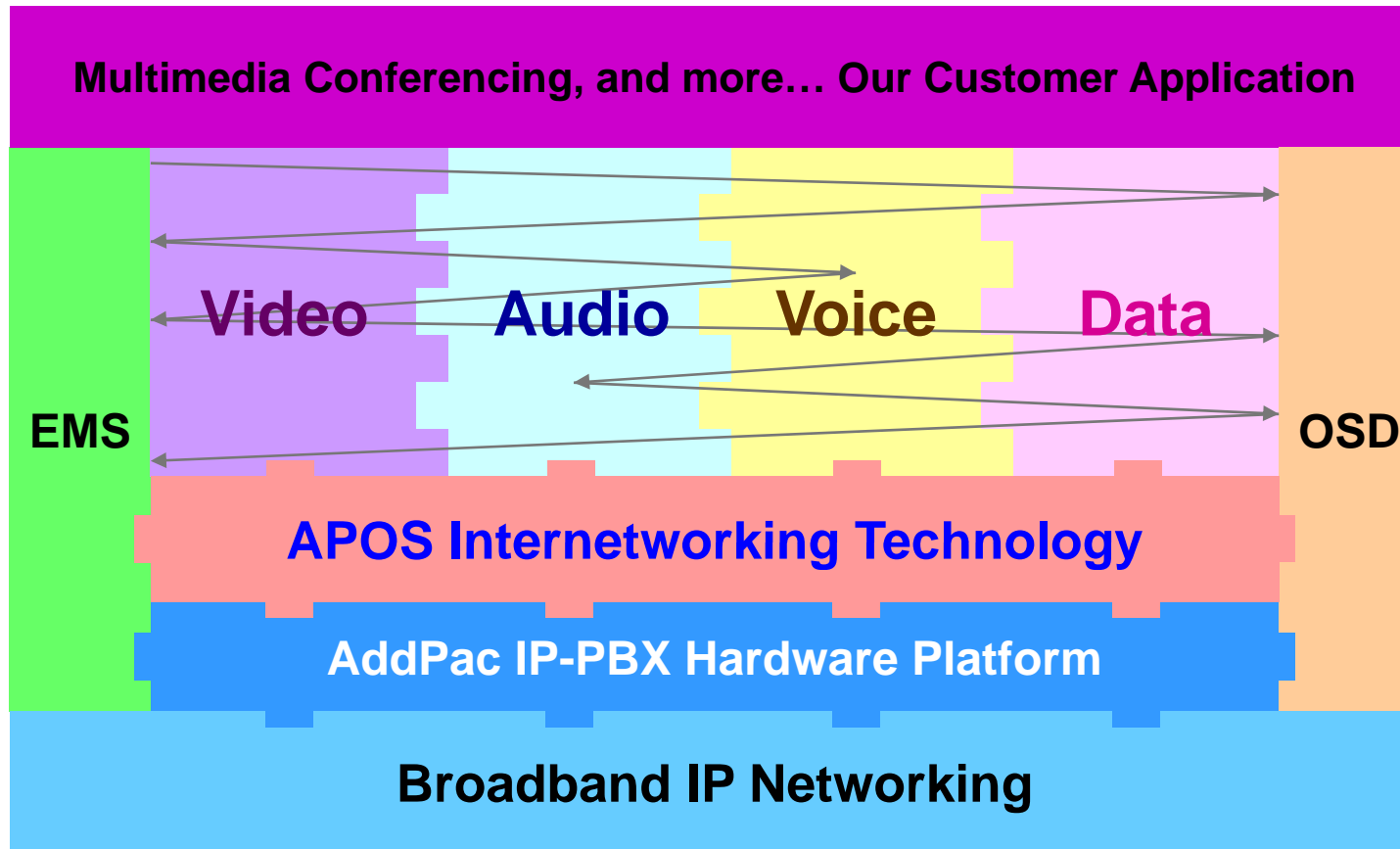

- APOS : AddPac Internetworking Operating System
- OSD : On- Screen Display
- EMS : Element Management System

Hardware Specification

IPNext50 IP-PBX for GSM service

RISC
CPU

High-end
DSP

- RISC Microprocessor Computing Power
+ High End Programmable DSP
- VoIP Gateway Interface
 - IPNext50 Model G1: Two(2) GSM Port
 - IPNext50 Model G2: Two(2) GSM Port + Two(2) FXS Port
- Network Interface
 - Two(2) 10/100Mbps Fast Ethernet (RJ45)
- RS232C Interface for Command Line Interface
- Power Supply
 - External Power Adaptor
- Power On/Off Switch
- Power LED, LAN LEDs, GSM, FXS Port LEDs

Hardware Specification

IPNext50 IP-PBX for GSM service

RISC
CPU

High-end
DSP

IP-PBX Service Diagram for GSM Interworking

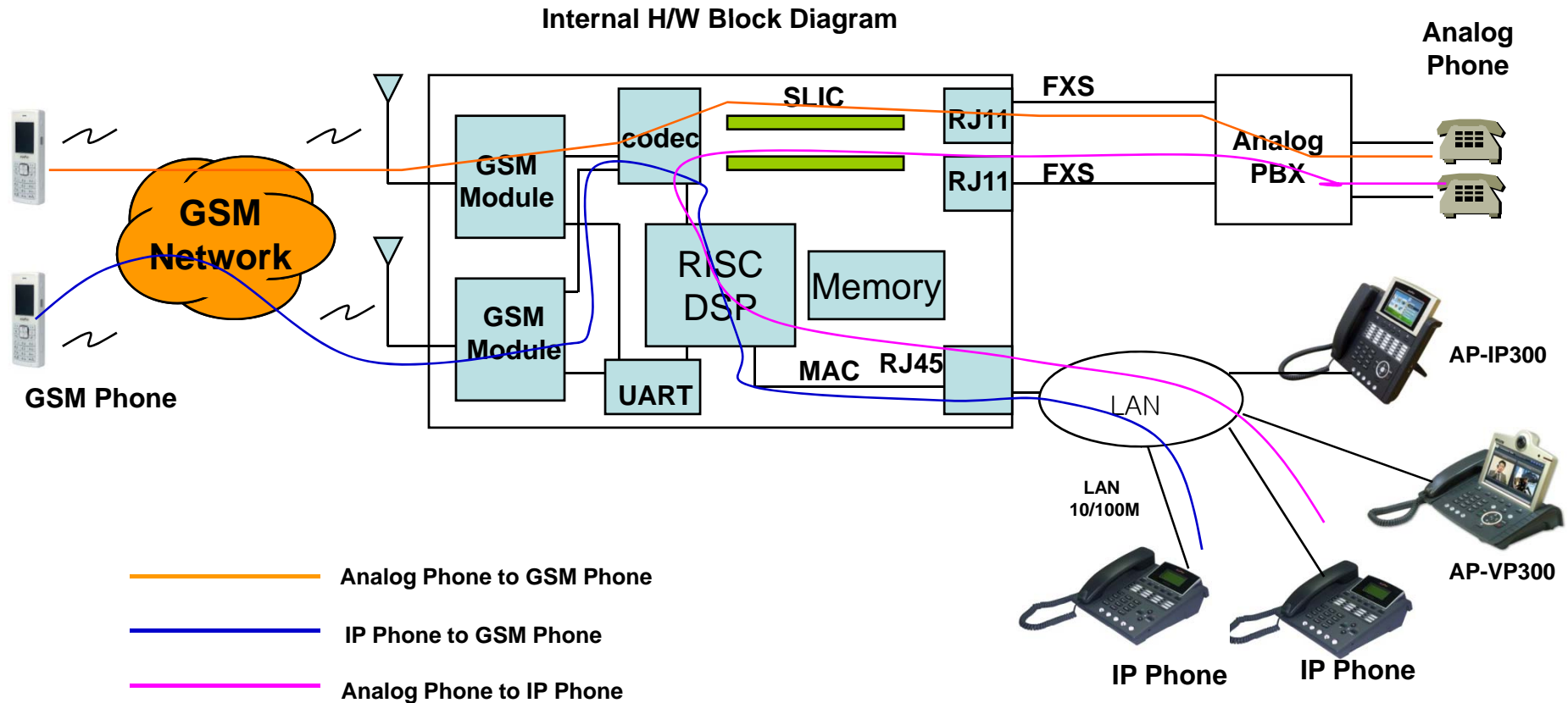

Hardware Specification

IPNext50 IP-PBX for GSM service

Hardware Specifications

IPNext 50 Series	Basic Specifications
CPU	High End RISC Microprocessor
Voice Interface	Mode B : 2FXO Interface(RJ11)
	Model C: 4FXO Interface(RJ11)
	Model D : 2FXO+ 2FXS Interface(RJ11)
	Model G1 : 2GSM Interface
	Model G2 : 2GSM+2FXS Interface
Ethernet Interface	2-Ports 10/100Mbps Ethernet Interface(RJ-45)
Flash Memory	High-speed Flash Memory for System, Voice Mail, etc
System Main Memory	128Mbyte High-speed SDRAM
Power Requirement	External Power Supply Adaptor / VAC 110~220V, 50/60Hz, 5V 3A
Operating Temperature	0°C ~ 45°C (32 °F ~ 122°F)
Storage Temperature	-40°C ~ 85°C (-40°C ~ 185°F)
Relative Humidity	5% ~ 95% (Non-condensing)
Dimensions	182mm x 182mm x 38mm (W x D x H)

Network interface Configurations

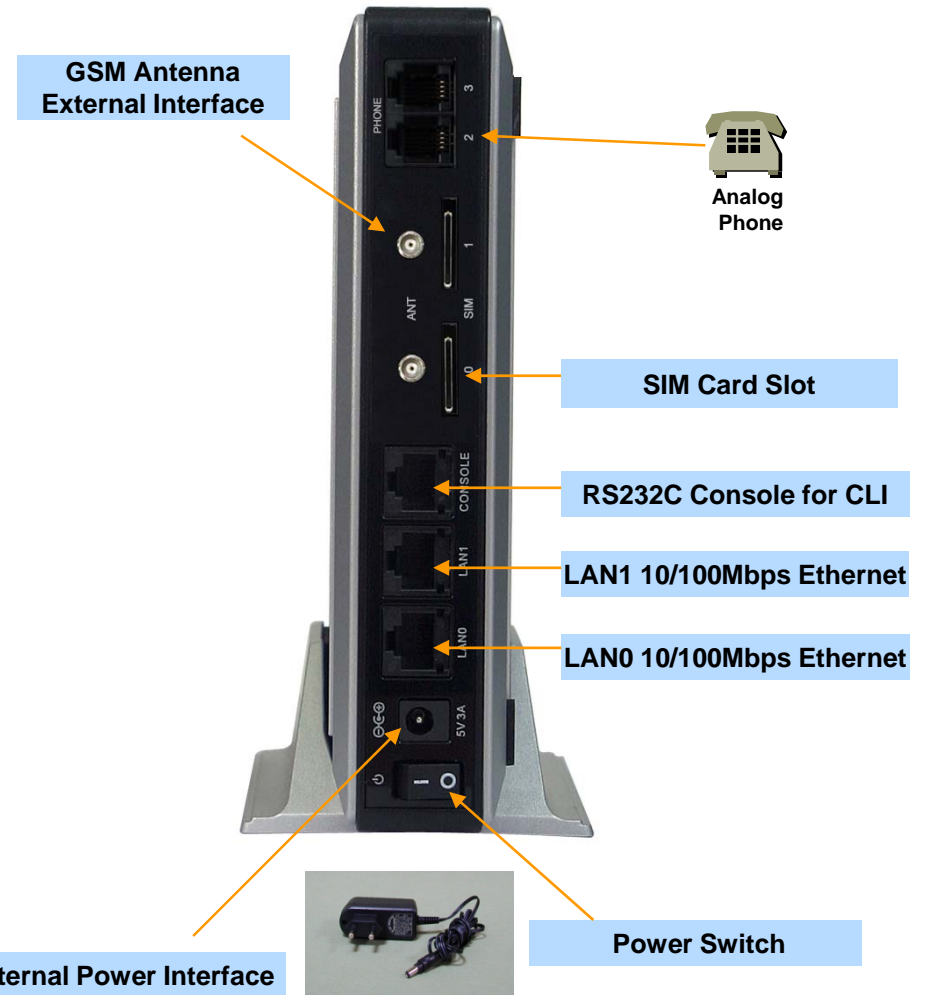

GSM Module Specification

IPNext50 IP-PBX for GSM service

- Bearers : GSM + GPRS multislots class 10
- Quad-Band EGSM 850/900/1800/1900MHz
- Normal Sensitivity
 - 850MHz Rx -102 dBm (min.) -110 dBm (typ)
 - 900MHz Rx -102 dBm (min.) -110 dBm (typ)
 - 1800MHz Rx -102 dBm (min.) -109 dBm (typ)
 - 1900MHz Rx -102 dBm (min.) -109 dBm (typ)
- Tx Performances
 - 850MHz Tx +33 dBm (max.)
 - 900MHz Tx +33 dBm (max.)
 - 1800MHz Tx +30 dBm (max.)
 - 1900MHz Tx +30 dBm (max.)
- Power Class 4 (33dBm nominal maximum output power)
- Codec
 - FR-EFR-HR-AMR

IP-PBX Features

IPNext50 IP-PBX for GSM service

- Signaling Server
 - SIP Application Server, Proxy, Registrar and Location Server (RFC3261)
 - Multiple ITSP Trunk with SIP & H.323 Accounts Support
 - IP UA Client Role for Registering to ITSP SIP Server
 - H.323 Gatekeeper Client Role for Registering to ITSP H.323 Gatekeeper Server
- IVR & Auto Attendant
 - Default Auto Attendant Support
 - Interactive Voice Response (IVR)
 - Provides with GUI-based Smart IVR Scenario Editor
 - Upload/Download Scenario by Smart IVR Scenario Editor
 - Supports Multiple Concurrent Scenarios
 - Supports Recordable IVR Prompts
- Voice Mail
 - Support Voice Mail with IVR
 - Access from Remote Site via Trunk Support
 - Voice Mail Notification Support

IP-PBX Features

IPNext50 IP-PBX for GSM service

- Conference
 - G.711 u-law, G.711 a-law Internal 3-Party Audio Conference Support
 - Ad-hoc Conference
 - Dial-Out Conference
 - Meet-me Conference
 - Multiple External MCU support(Video, Audio, etc) : AddPac AP-MC1000, etc
 - Conference Chair and Participants Management
- Music & Announcement
 - Music on Hold
 - Replaceable Announcements
 - Dialing Music / Tone Service

IP-PBX Features

IPNext50 IP-PBX for GSM service

- Number & Call Routing
 - Trunk Hunting by Preference or Sequential
 - Call Hunting by Preference, Simultaneous, Random
 - Call Hunting by Chained Hunting Group
 - Partition for Address Grading
 - Call Class for Call Access Control
 - Number Translation Rule for Inbound/Outbound Call
 - Centrex with Prefix Support
 - Multiple Shared Devices with One Number
 - Multiple Numbers on One Device
 - Individual Call Park within Park Number Pool
 - Group Call Park within a Group or Other Group
 - Call Pickup of Ringing Call of Same Group or Other Group
 - Call Pickup of Parked Call
 - Call Transfer - Blind, Consult
 - Call Forwarding - Unconditional, Busy, No Answer, Voice Mail
 - Call Waiting
 - Call Swapping
 - Call Hold

IP-PBX Features

IPNext50 IP-PBX for GSM service

- IP-PBX Advanced Features with AddPac IP, Video Phones
 - Multiple Call Handling with Call Status and Calling Line Number and Name
 - Plug and Play with Auto Discovery Function
 - Softkey Map Download and Control
 - Time and Date Setting
 - Voice Mail List View
 - Parked Call List View
 - Call Forward Setting
 - Recent Call List View
 - Calling Number and Name Identification
 - Individual Call Park within Park Number Pool by Softkey
 - Group Call Park within a Group or Other Group by Softkey
 - Call Pickup of Ringing Call of Same Group or Other Group by Softkey
 - Call Pickup of Parked Call by Softkey
 - Call Transfer - Blind, Consult by Softkey
 - Call Waiting Indication
 - Call Swapping by Softkey
 - Call Hold by SoftKey
 - Conference Control

IP-PBX Features

IPNext50 IP-PBX for GSM service

- User & Device Management
 - LDAP (Lightweight Directory Access Protocol) Support
 - Supports Hierarchical Organization
 - Auto Discovery of IP Phones & Video Phones
 - Monitoring Status of Phones
- Miscellaneous*
 - Distinctive Ring by Calling User
 - Auto Config & Upgrade
 - Intercom
 - Personal Directory
 - Downloadable Ring
 - Do not Disturb



RTP Proxy Function

IPNext50 IP-PBX for GSM service

- Protocol Independence (H.323, SIP)
- Built-In RTP Proxy for Small Office
- Support RTP Proxy without NAT
- Support Symmetric / Asymmetric NAT
- Support IPv4/IPv6 RTP Proxy
- Support RTP Broadcast
- Support RTP Conference

RTP Proxy Features

IPNext50 IP-PBX for GSM service

Public/Private RTP Proxy without NAT Router

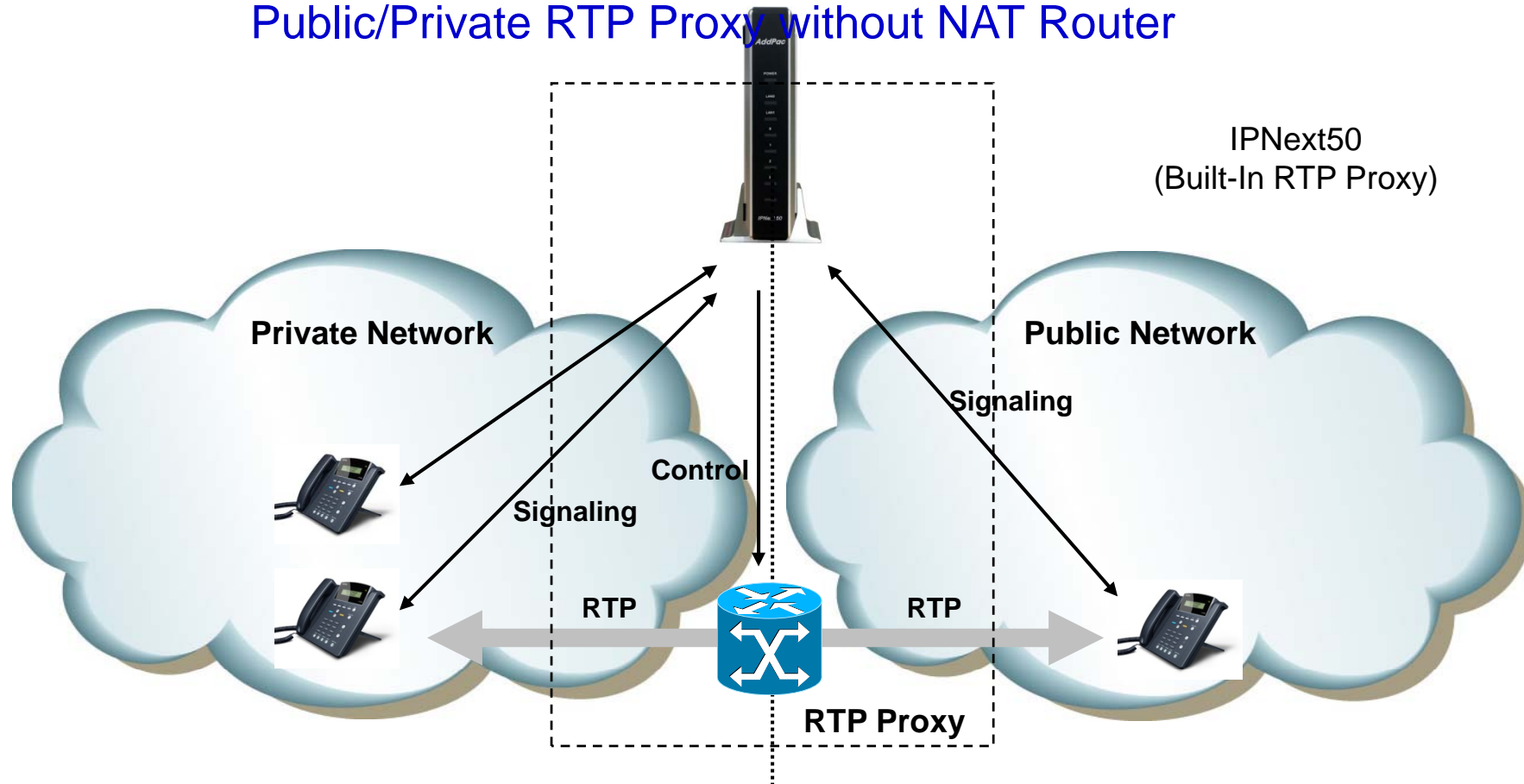

- Located between public and private network
- Call manager and RTP proxy has public and private address
- Call manager determine that the call is internal or external

RTP Proxy Features

IPNext50 IP-PBX for GSM service

Asymmetric/Symmetric NAT

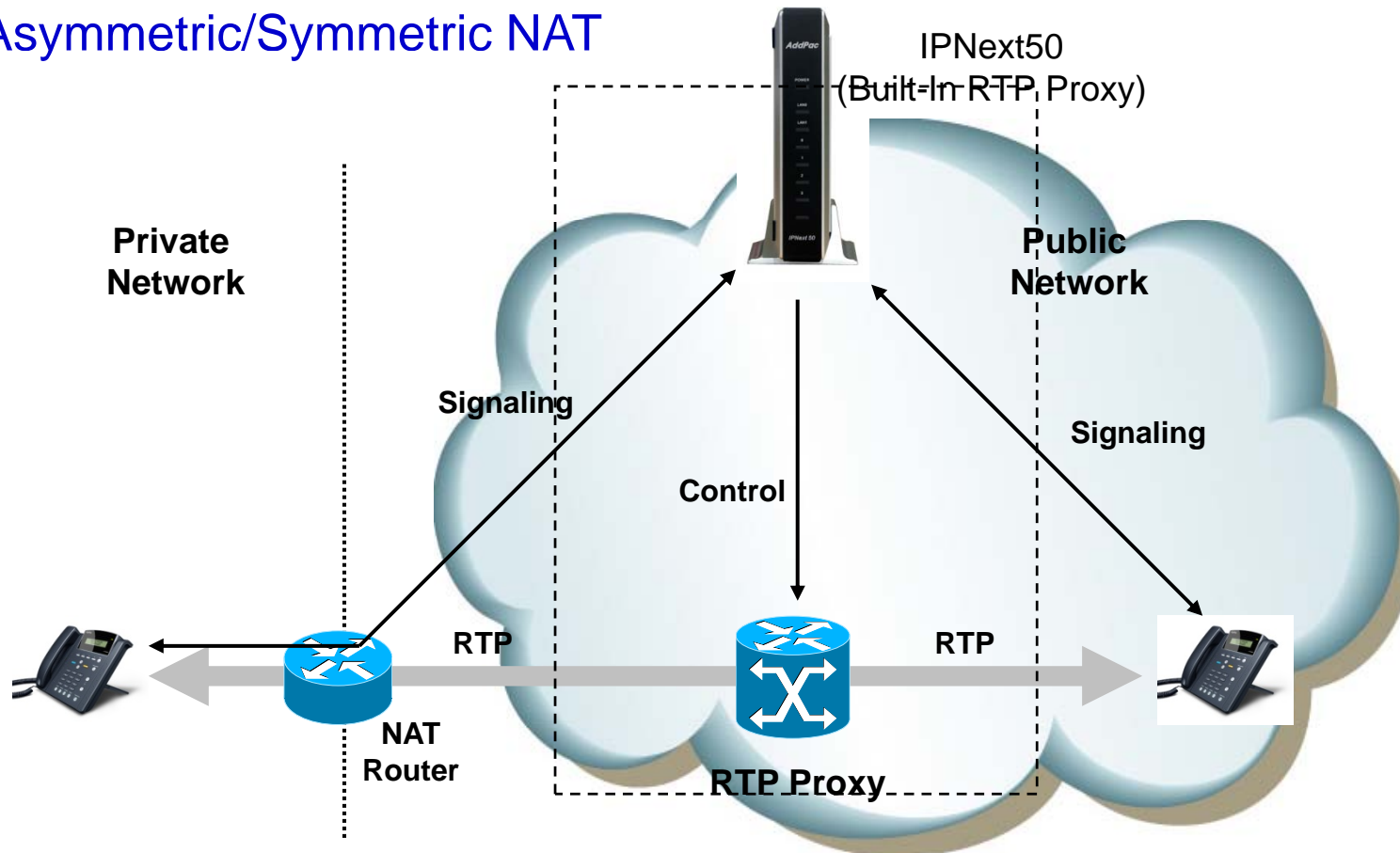

- Located in public network
- RTP Proxy has single public address
- Auto detect for asymmetric NAT via incoming RTP packet

RTP Proxy Features

IPNext50 IP-PBX for GSM service

RTP Proxy Communication between Private IP

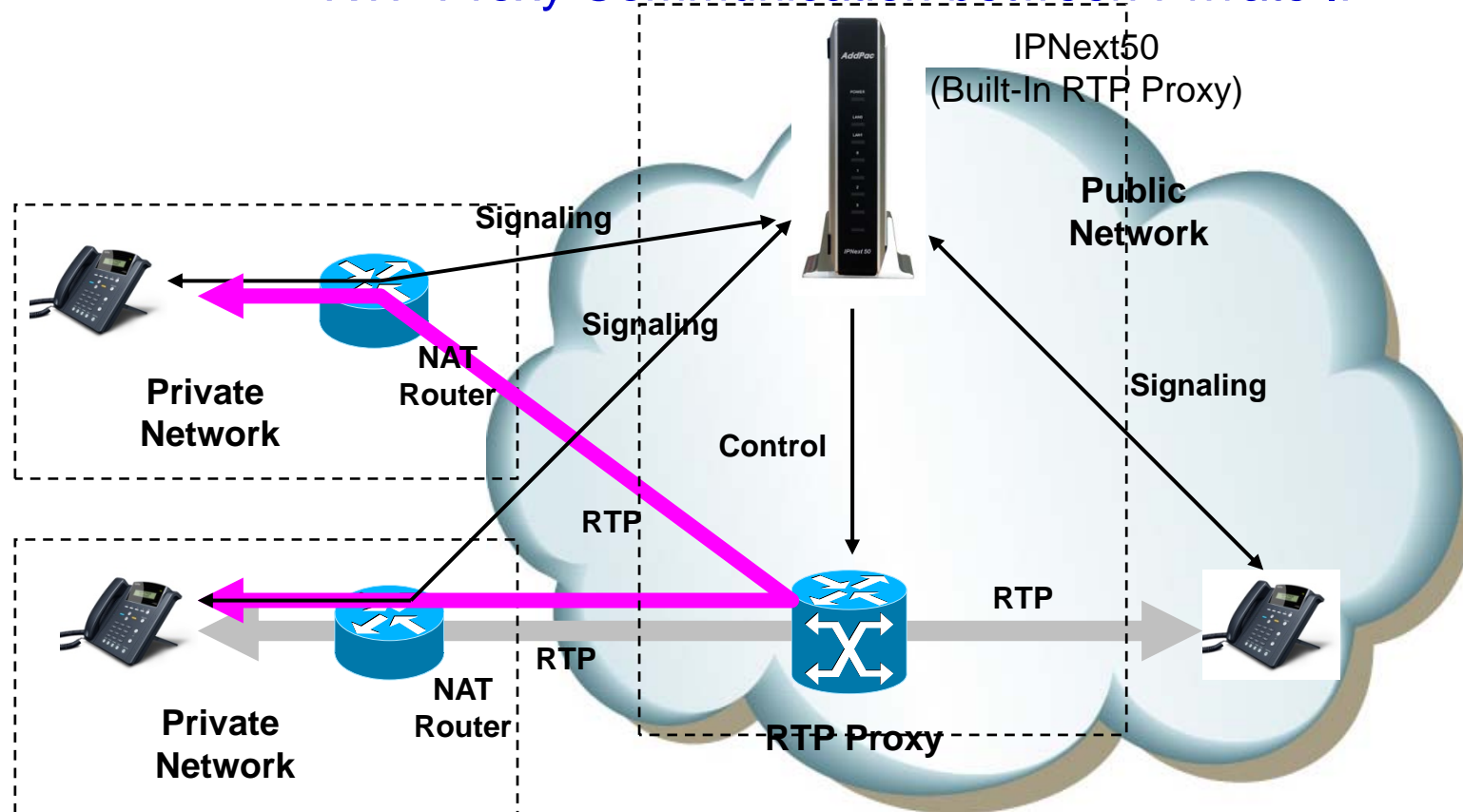

- Located in public network
- RTP Proxy has single public address
- Auto detect for asymmetric NAT via incoming RTP packet

RTP Proxy Features

IPNext50 Next Generation IP-PBX

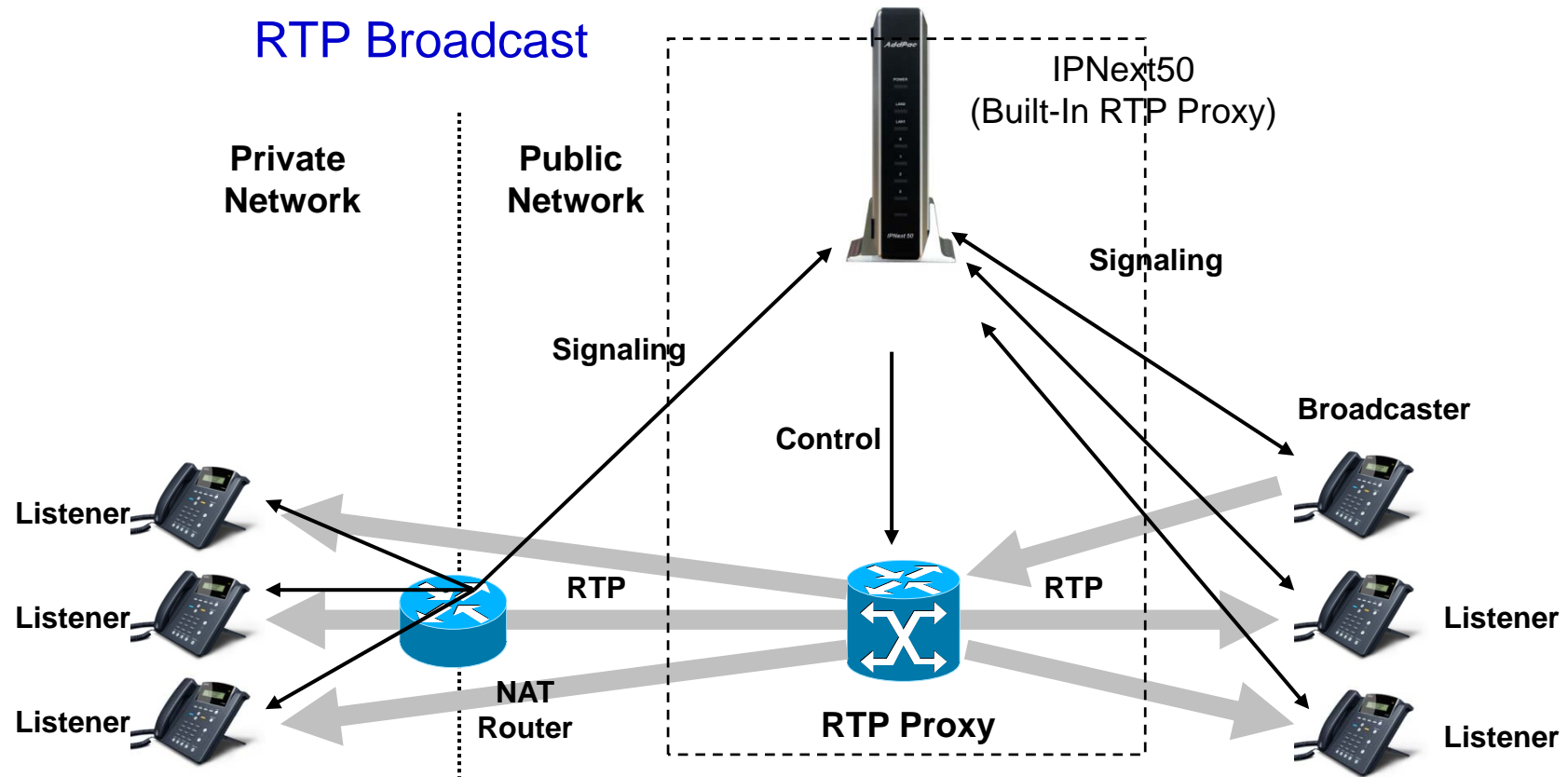

- Call Manager set the broadcaster and listener via control message
- One broadcaster and multiple listener
- RTP proxy relay for broadcaster RTP traffic
- RTP proxy never relay for listener traffic

RTP Proxy Features

IPNext50 IP-PBX for GSM service

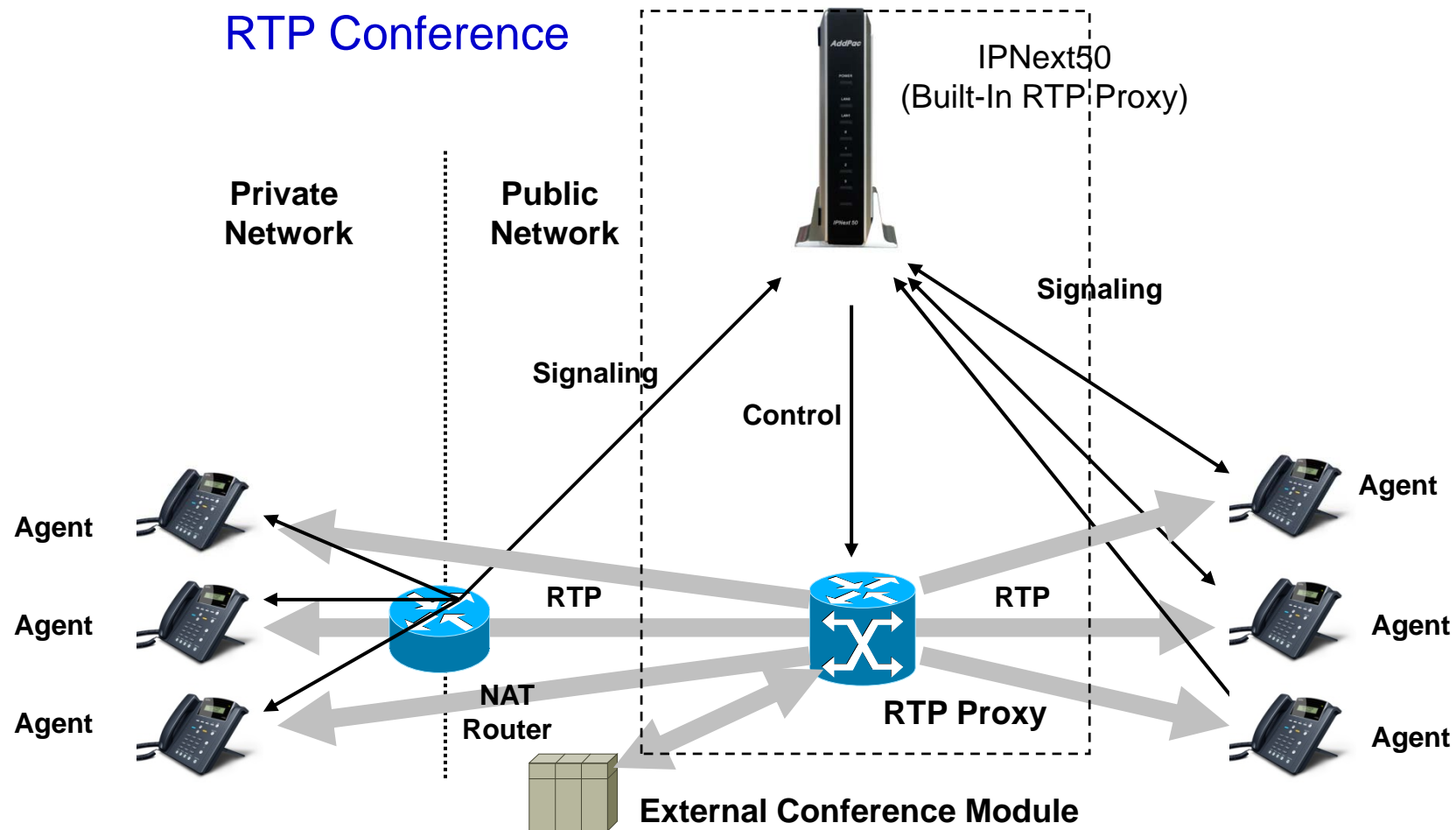

- RTP Proxy communicate with external/internal conference module (mixer)
- Conference support for private address, asymmetric NAT

VoIP Gateway Service

IPNext50 IP-PBX for GSM service

- H.323, SIP, and MGCP Triple Stack
- H.323
 - ITU-T Standard H.323 v3 Support
 - Support H.245 Tunneling
 - Including H.235 Security Features
- SIP
 - IETF RFC3261 or RFC2543 SIP Standard
- MGCP
 - IETF RFC2705bis-02 Standard MGCP 1.0

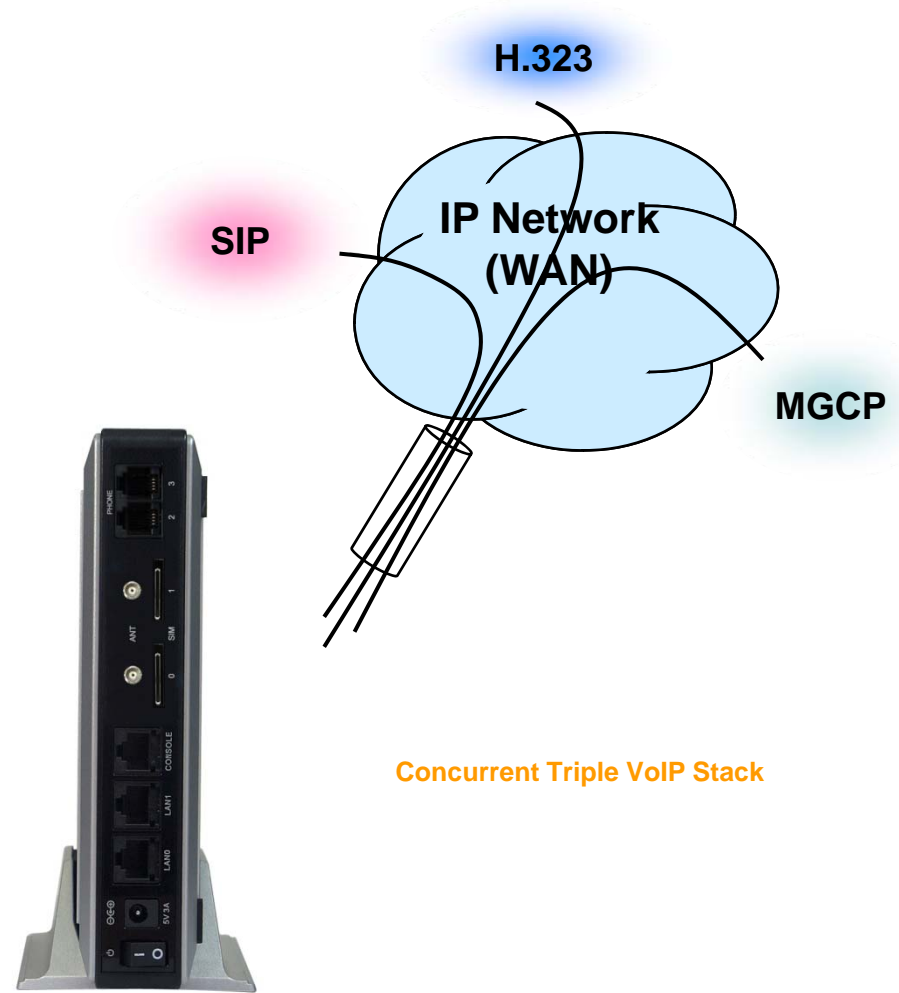
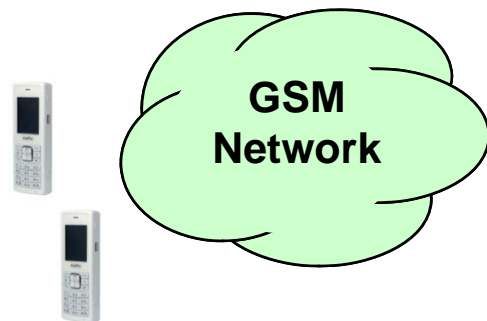

VoIP Gateway Service

IPNext50 IP-PBX for GSM service

- H.323

- Fast connect, normal connect support
- H.245 tunneling support
- Q.931 response message setting for inbound VoIP calls
- H.245 logical channel open timing selection function
- Start H.245 procedure support
- DTMF / Hook flash relay with H.245 alphanumeric / signal
- Secondary gatekeeper support
- Gatekeeper assignment according to the domain name
- Gatekeeper discovery with multicast
- Lightweight RRQ support
- Signaling TCP port assignment
- Resource threshold setting with RAI
- H.235 clear-token, crypto-token support
- canMapAlias support
- Technical prefix (supported prefix) support
- Public IP assignment in NAT environment

- SIP

- Gateway-based / Endpoint-based registration support
- Secondary proxy-server assignment function
- SIP signaling port change function
- SIP proxy server assignment according to the domain name
- T.38 real-time fax relay support
- DTMF relay support with RFC2833 / OPTION message
- Re-INVITE support

- MGCP

- Secondary call agent assignment function
- Default package assignment
- Announcement Server Package, Generic Media Package, Handset Package, Line Package, Trunk Package support
- MGCP call agent assignment according to the domain name
- T.38 real-time fax relay support
- DTMF relay support based on RFC2833



VoIP Gateway Service

IPNext50 IP-PBX for GSM service

- Voice Codec

- G.711 A-Law, G.711 U-Law
- G.726 r16, G.726 r32
- G.729A
- G.723.1 r63, G.723.1 r53
- VAD (Voice Activity Detection) function support
- DTMF relay support (H.323, SIP, MGCP common) based on RFC2833

- RTP

- Redundant RTP packet transmission in case of severe packet loss
- Dynamic jitter buffer management and RPT packet jitter and loss compensation with heuristic & DSP error concealment
- Static jitter buffer setting support
- Voice frame per RTP packet number control for each codec
- In-band ring-back tone support
- Virtual ring-back tone support
- Tone parameter change support

- FAX

- Fax relay mode supporting T.38, inband-T.38, bypass mode
- Lost packet compensation with redundant setting in case of T.38 fax relay
- Fax relay mode, rate setting for remote end

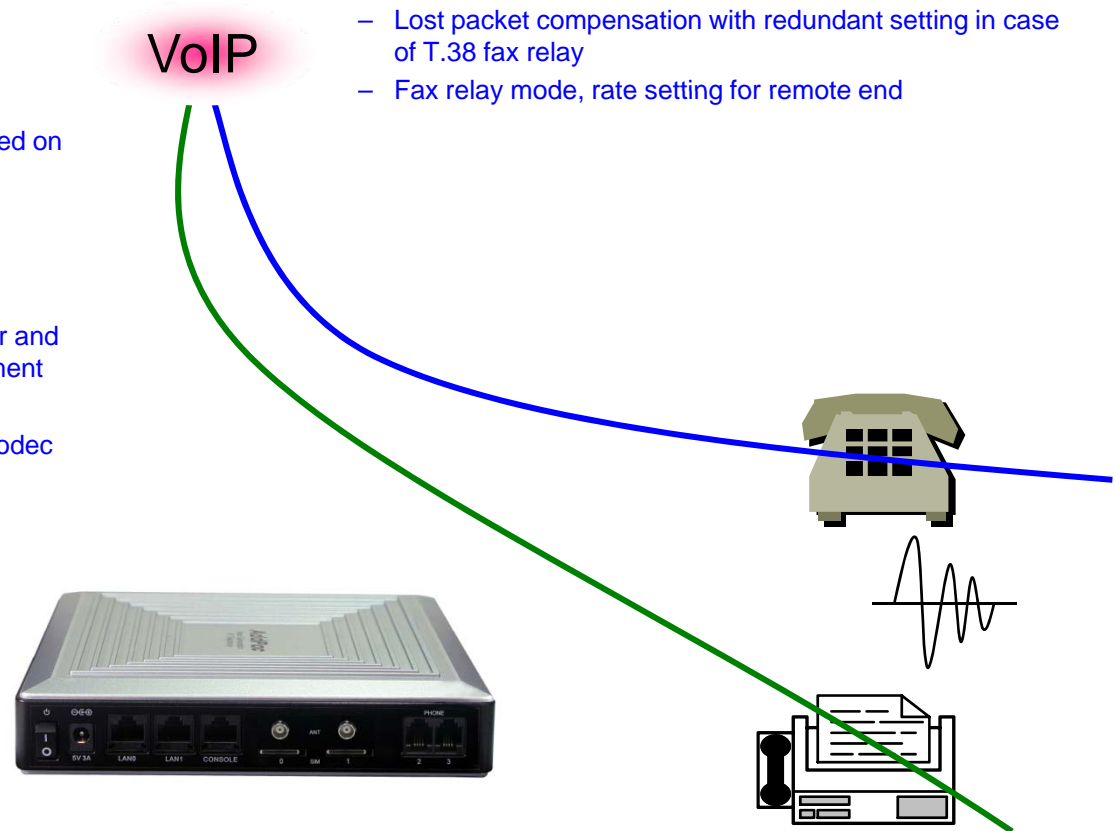

VoIP Gateway Service

IPNext50 IP-PBX for GSM service

• VoIP Call Controls

- Hot line connection function with PLAR (Private Line Auto Ring Down)
- Leased line emulation function
- Connection monitoring function
- Fault tolerant with Redundancy and Call Distribution among Gateways for load balancing
- Call attempt with IP address
- H.323, SIP, MGCP inbound call connection for each voice port
- Multiple E.164 setting for one voice port
- One E.164 or digit pattern can be assigned to more than one voice port
- Hunting with Longest match/ priority/ sequence/ random
- One stage call setup by Digit forwarding
- Call barring with specific digit patterns
- Calling and called number conversion for PSTN outbound calls
- PSTN rerouting in case of VoIP call attempt failure

• VoIP Call Controls (cont.)

- Call transfer for internal calls
- Call pickup for internal calls
- Calling and called number conversion for VoIP outbound calls
- Calling and called number conversion for VoIP inbound calls
- Fax broadcasting call control

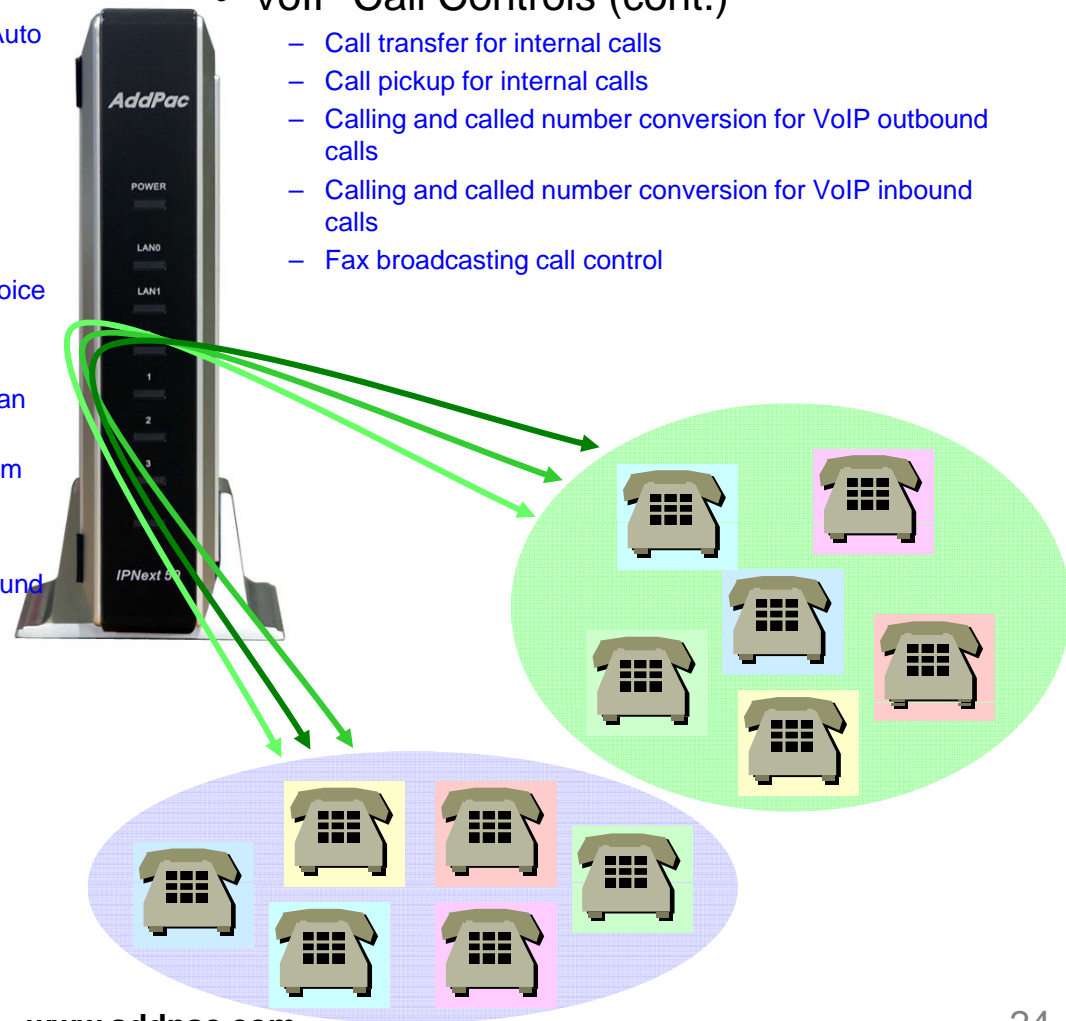

Advanced QoS Features

IPNext50 IP-PBX for GSM service

- Enhances **Transmit** Voice QoS Features

- Voice Traffic Priority Queuing
- QoS Service Profiling
- Providing Virtual Network Transmit Algorithm
- Real-time Voice Traffic QoS Support
- RTP Packet Transmit Interval Control
- Supporting RTP Packet Redundancy Scheme
- IP Header Control such as ToS, Diffserv

- Enhances **Receive** Voice QoS Features

- Dynamic Jitter Buffer Management
- Error Concealment
- Support T.38 FAX Data Error Recovery Scheme

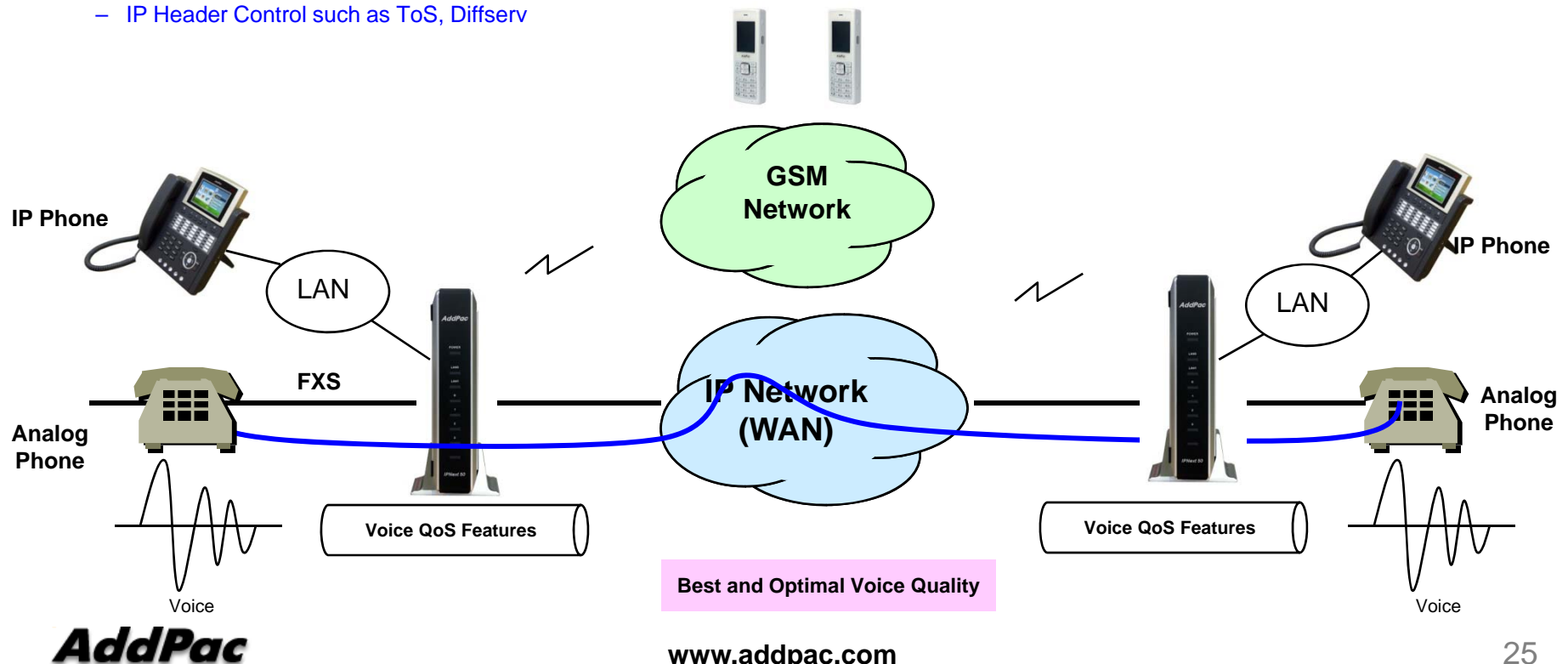

Network Protocols (Cont.)

IPNext50 IP-PBX for GSM service

Basic Network Protocols

- ARP, IPv4, TCP, UDP, ICMP, SCTP, IGMP, MLD

Routing Protocol

- IPv4 : Static
- IPv6 : Static

Service Protocol

- FTP, Telnet, TFTP, DHCP Server/Relay, SNMP Server
- CDP (Cisco Discovery Protocol)
- DNS Resolver , DDNS(nsupdate)
- Bridge
- Syslog
- IP/IPv6 policy control (QoS)
- VPDN (Virtual Private Dial-up Network : L2TP Server)

Miscellaneous

- Cisco Style CLI
- Standard & Extended IPv4 Access List
- Multi-level User Account Management
- IP accounting
- STUN Client

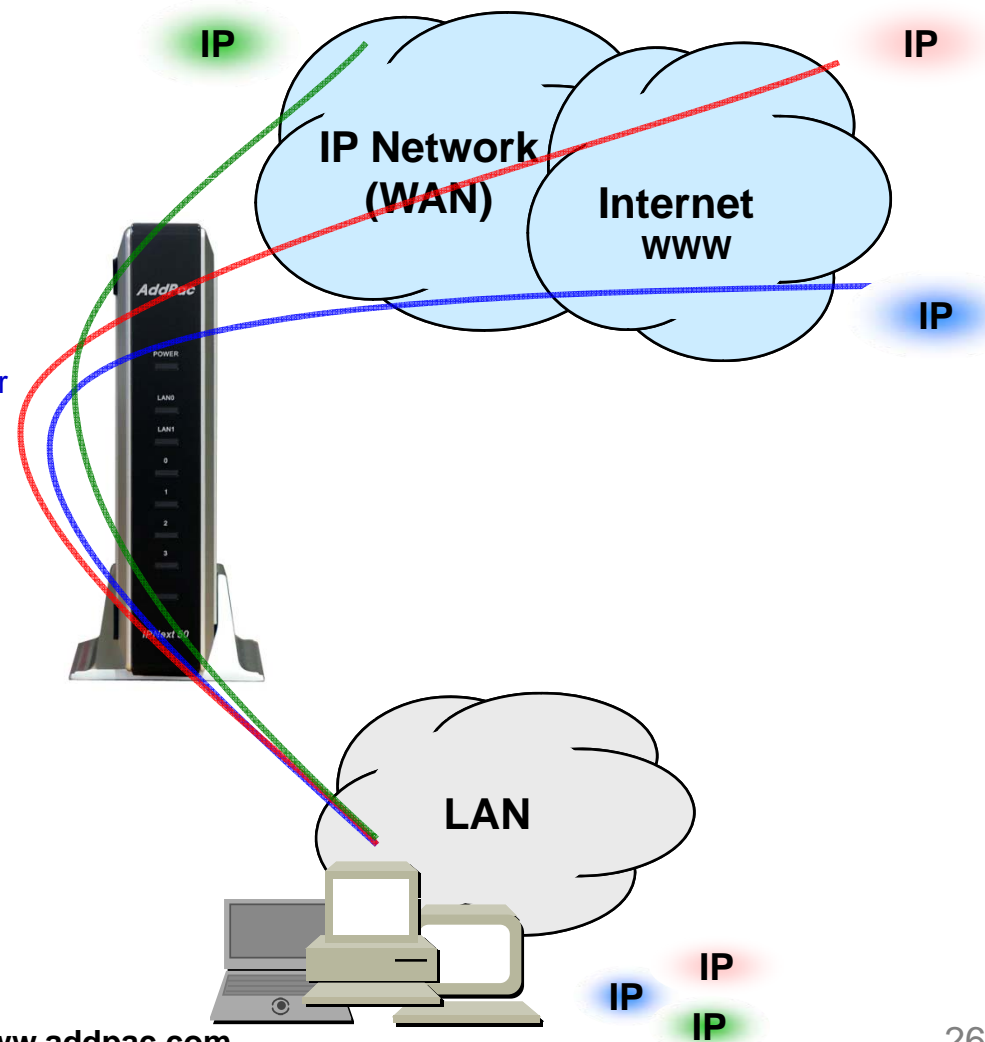

Network Protocols

IPNext50 IP-PBX for GSM service

IPv4/IPv6 Interworking

- NAT/PAT for IPv4
- IP connect (formerly ip-share) and device cascade for IPv4
- IP/IP, IP/GRE tunneling
- NAT-PT
- 6to4, Autoconfig tunneling

IPv4 Address Configuration

- Fixed (Static)
- DHCP
- PPPoE

IPv6 Address Configuration

- Fixed (Static)
- EUI-64
- Autoconfig (Neighbor Advertisement and Solicitation)

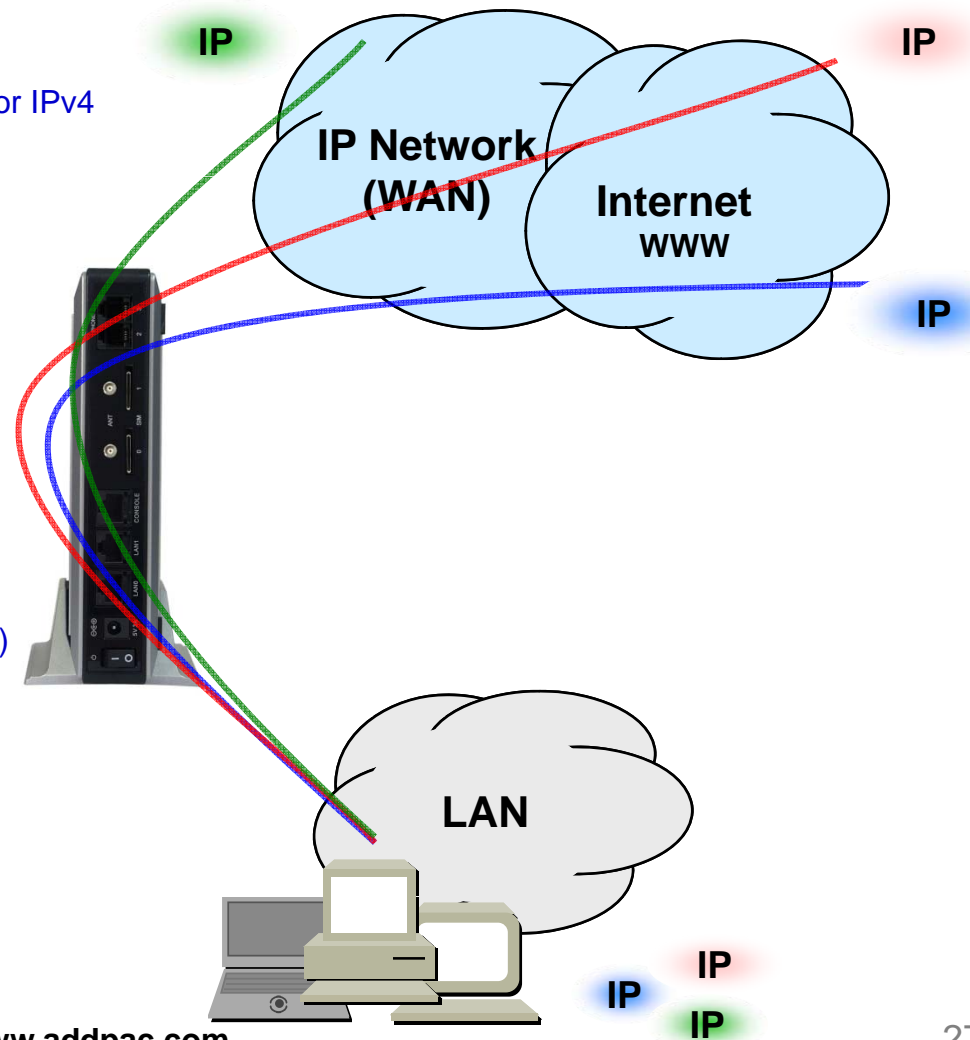

Security Management

IPNext50 IP-PBX for GSM service

- IP packet filtering
- IP access list
- User authentication function
 - Password Authentication Protocol (PAP)
 - Challenge Handshake Authentication Protocol (CHAP)
- Enable/Disable specific protocols
- Auto-square connect of Telnet session
- Account Management function for multi-level user
- SNMP/TELNET/FTP/HTTP/TFTP port assignment function
- SNMP/TELNET/FTP access list management
- Boot mode security checking function

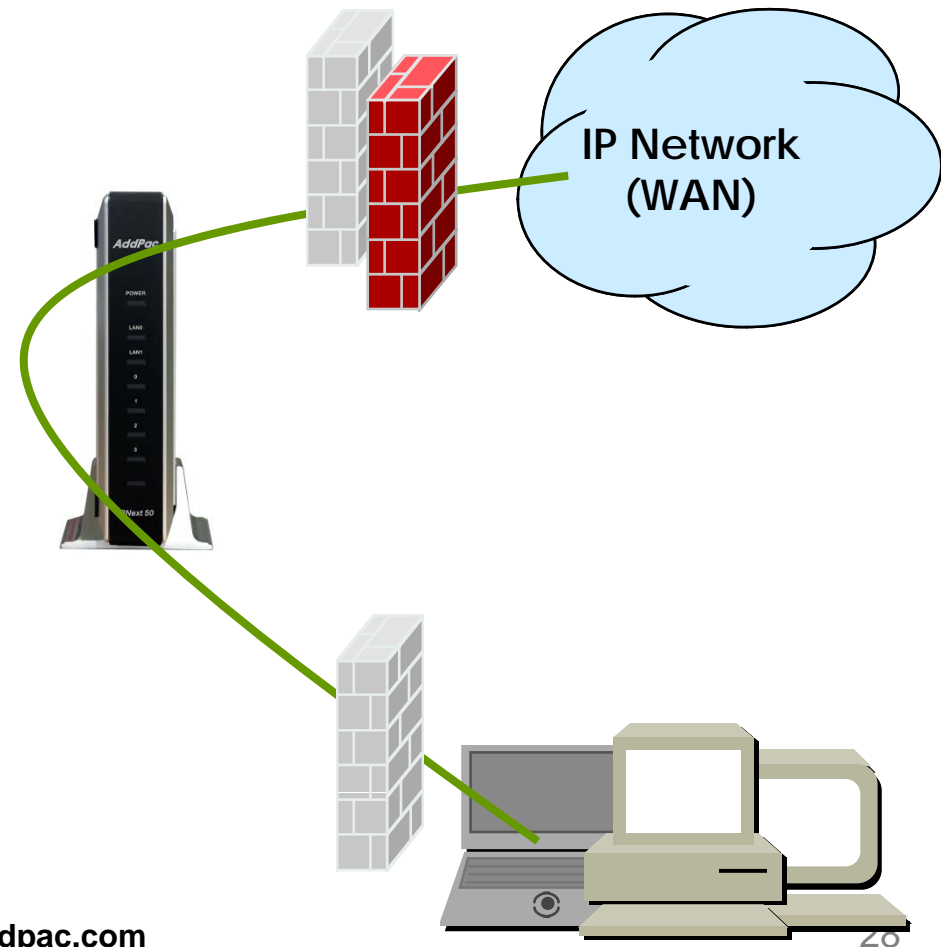

Smart Multimedia Manager

IPNext50 IP-PBX for GSM service

- Web based Smart and Easy Management Tool Support
- User, Device, Call, Conference Management with Intuitive User Interface
- Built in Event Manager or External Event Manager Support
 - Event Configuration with Event Source Filter and Event Logging Filter
 - Event Monitoring with Colorful Format
 - Debug Level Syslog Monitoring Support
 - Event Analysis by Smart Event Analyzer
- Active Call Monitoring Support
- Call Tracing Support
- Active Conference Monitoring Support
- Call History Viewer Support
- Backup, Restore and Initializing of Database Support
- Export and Import of Database to Excel File Support

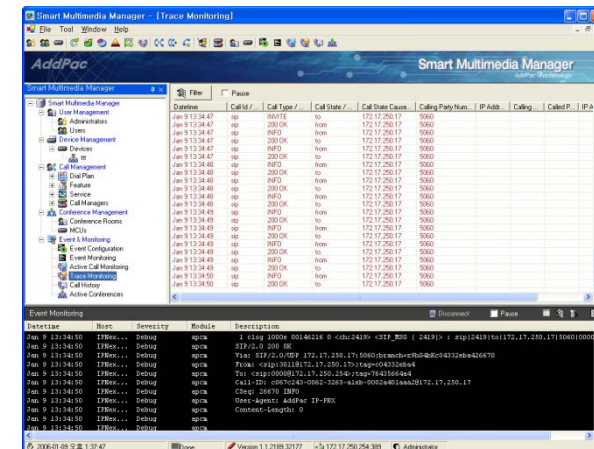

IP Multimedia Terminals

IPNext50 IP-PBX for GSM service

- AP-VP500 Video Phone
- AP-VP350 MCU Video Phone
- AP-VP300 Video Phone
- AP-VP280 Video Phone
- AP-VP250 Video Phone
- AP-VP150 Video Phone
- AP-VP120 Video Phone
- AP-IP300 Premium IP Phone
- AP-IP250 IP Phone
- AP-IP160 IP Phone
- AP-IP120 IP Phone
- AP-IP90 IP Phone
- AP-WP100 WiFi Phone
- AP-SMP100 Soft Phone



AP-VP500



AP-VP300



AP-VP150



AP-WP100



AP-VP120



AP-IP300











AP-IP160



AP-IP120





IP Video Phones

IPNext50 IP-PBX for GSM service

	AP-VP500	AP-VP350	AP-VP300N	AP-VP280	AP-VP250	AP-VP230	AP-VP150	AP-VP120
								
LCD Size	12.1 Inch Touch Screen	7Inch Touch Screen	7Inch Touch Screen	7Inch Touch Screen	4.3Inch Touch Screen	5Inch Touch Screen	4.3Inch Touch Screen	4.3Inch
Camera	CCD	CCD	CCD	CMOS	CMOS	CMOS	CCD	CMOS
Video Codec	H.263 MPEG4 H.264	H.263 MPEG4 H.264	H.263 MPEG4 H.264	H.263 MPEG4 H.264	H.263 MPEG4 H.264	H.263 MPEG4 H.264	H.263 MPEG4 H.264	H.263 MPEG4 H.264
Signaling	H.323/SIP	H.323/SIP	H.323/SIP	H.323/SIP	H.323/SIP	H.323/SIP	H.323/SIP	H.323/SIP
Video MCU	N/A	4-Party Video MCU	N/A	N/A	N/A	N/A	N/A	N/A
Voice MCU	3-Party	3-Party	3-Party	3-Party	3-Party	3-Party	3-Party	3-Party
LAN Port	2	2	2	2	2	2	2	2
PoE	N/A	N/A	Support	N/A	Support	Support	Support	Support



IP Phones

IPNext50 IP-PBX for GSM service

	AP-IP300	AP-IP250	AP-IP230	AP-IP160	AP-IP120	AP-IP90
						
LCD Size	4.3 Inch Color LCD	4.3 Inch Color LCD	5 Inch Color LCD	4 Text Line Graphic LCD	4 Text Line Graphic LCD	4 Text Line Graphic LCD
Touch Screen	N/A	Support	Support	N/A	N/A	N/A
Speed-Dial Keys	25 Key with Presence LED	Touch Screen based 25 Keys	Touch Screen based 25 Keys	16 Key with Presence LED	12 Key with Presence LED	N/A
Voice Codec	G.711/G.726/G.729/G.723	G.711/G.726/G.729/G.723	G.711/G.726/G.729/G.723	G.711/G.726/G.729/G.723	G.711/G.726/G.729/G.723	G.711/G.726/G.729/G.723
Signaling	H.323/SIP	H.323/SIP	H.323/SIP	H.323/SIP	H.323/SIP	H.323/SIP
3-Party Conversation	Support	Support	Support	Support	Support	Support
LAN Port	2	2	2	2	2	2
PoE(Optional)	Support	Support	Support	Support	Support	Support
FXO(Optional)	Support	Support	Support	Support	Support	Support

IP Extend Key Terminals

IPNext50 IP-PBX for GSM service

Model	AP-PT100	AP-PT50	AP-PT20
Service Features			
Key Type	7 inch LCD Touch Screen	Push Button with User Presence Indication LAMP	Push Button with User Presence Indication LAMP
Key Number	Default : 9(row) x 4(column) = 36	60 Key	40 Key
User Presence Indication	Support	LED on, LED off, LED Blink	LED on, LED off, LED Blink
Multiple Cascading	Support	Support	Support
Speaker	Support	Support	Support
LAN Port	2	2	2
PoE(Optional)	Support	Support	Support
Application	IP Phone or Video Phone Extend Key Pack	IP Phone or Video Phone Extend Key Pack	IP Phone or Video Phone Extend Key Pack

IP Wifi Phone

IPNext50 IP-PBX for GSM service

- Wi-Fi IP Phone Solution
- Various Call Scenario Support (IP-PBX)
- State-of-art SIP Signaling
- IEEE802.11b/g up to 54Mbps
- WPA(Wifi Protected Access), 802.11i Security Standard
- Wi-Fi IP Audio Broadcasting Terminal Solution
- External Audio In/Out Port for Headset
- Firmware Upgradeable Architecture
- VoIP Solution with Outstanding Network Service Capability
- Audio Privacy Protection



Smart Messenger

IPNext50 IP-PBX for GSM service

- Support Messenger Service
- Support Various Address Book
- Support User Presence Information
- Support User Search Feature
- Interoperation with Address Book and Smart Phone
- Support Smart Phone Control and Setup
 - Call Control and Forward Setup
- Support Unified Message Box
 - Voice Mail Box
 - Short Message Box



IPNext50
IP-PBX



AddPac Smart Messenger

Standard IP-PBX Application

IPNext50 IP-PBX for GSM service

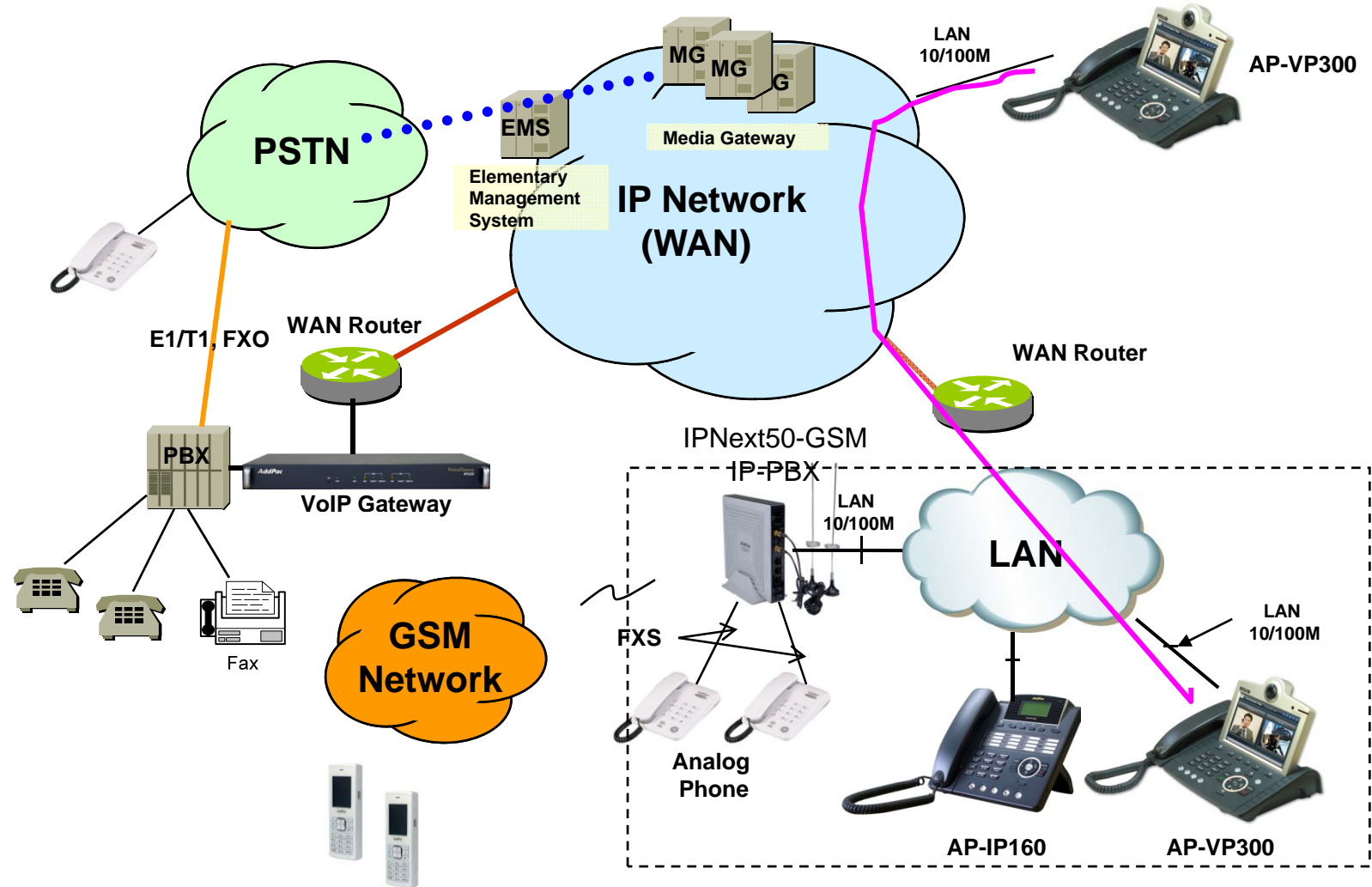

Ordering Information

- **IPNext50 IP-PBX Hardware**
 - RISC Microprocessor with High-end Programmable DSP Architecture
 - 2-ports 10/100Mbps Fast Ethernet(RJ45)
 - 1-Port RS232C Interface for Command Line Interface
 - VoIP Gateway Interface
 - GSM Interface (IPNext50 Model G1,G2)
 - Including Network Cable, Antenna & Ext. Power Supply, etc.
- **Built-in APOS Internetworking Software for IPNext50**
- **Including 1 Year Hardware Warranty**
- **Product Documents**
 - Install and Operation Guide (PDF)
- **Pricing**
 - AddPac Technology Regional Sales Manager
 - Authorized Sales and Marketing Representatives
 - Please Contact www.addpac.com

IPNext IP-PBX Series

Thank you!

AddPac Technology Co., Ltd.
Sales and Marketing

Phone +82.2.568.3848 (KOREA)

FAX +82.2.568.3847 (KOREA)

E-mail sales@addpac.com