



IPNext2000™ NGN IP-PBX

High-performance Next Generation IP-PBX Solution

Preliminary Product Overview

(Without notice, following described technical spec. can be changed)



AddPac

AddPac Technology

2012, Sales and Marketing

Contents

- Product Overview
- Hardware Specification
- System Redundancy Features
- Software Service
- IP Telephony Service and Features
- RTP Proxy Service
- User Presence Service
- Network Service and Features
- User Terminals
- Application Area
- Ordering Information



Product Overview

IPNext2000 Next Generation IP-PBX System

- SIP Application Server, Proxy, Registrar and Location Server
- Multiple ITSP Trunk with SIP & H.323 Accounts Support
- Dual System Redundancy Architecture
 - Two(2) Gigabit Ethernet Interface / System
- High Performance RISC Architecture
- Powerful Network Protocols (PPPoE, DHCP, Static Routing, etc)
- IPv4/IPv6 Dual Stack
- RTP Proxy Function Embedded for Private IP and IPv6 Address Interworking
- User Presence Service Features for Smart Multimedia Messenger and Smart IP Phone
- IVR Scenario Editor, Voice Mail, Media Service (Coloring), Conference
- Firmware Upgradeable Architecture
- Smart Multimedia Manager for IP-PBX Management
- Smart Messenger Service (click to dial) for Unified Communication
- Smart NMS for Large Scale Deployment
- Advanced Voice QoS Mechanism
- Dual Redundancy Power Module

Product Highlights

IPNext2000 Next Generation IP-PBX System

IP based Advanced IP-PBX

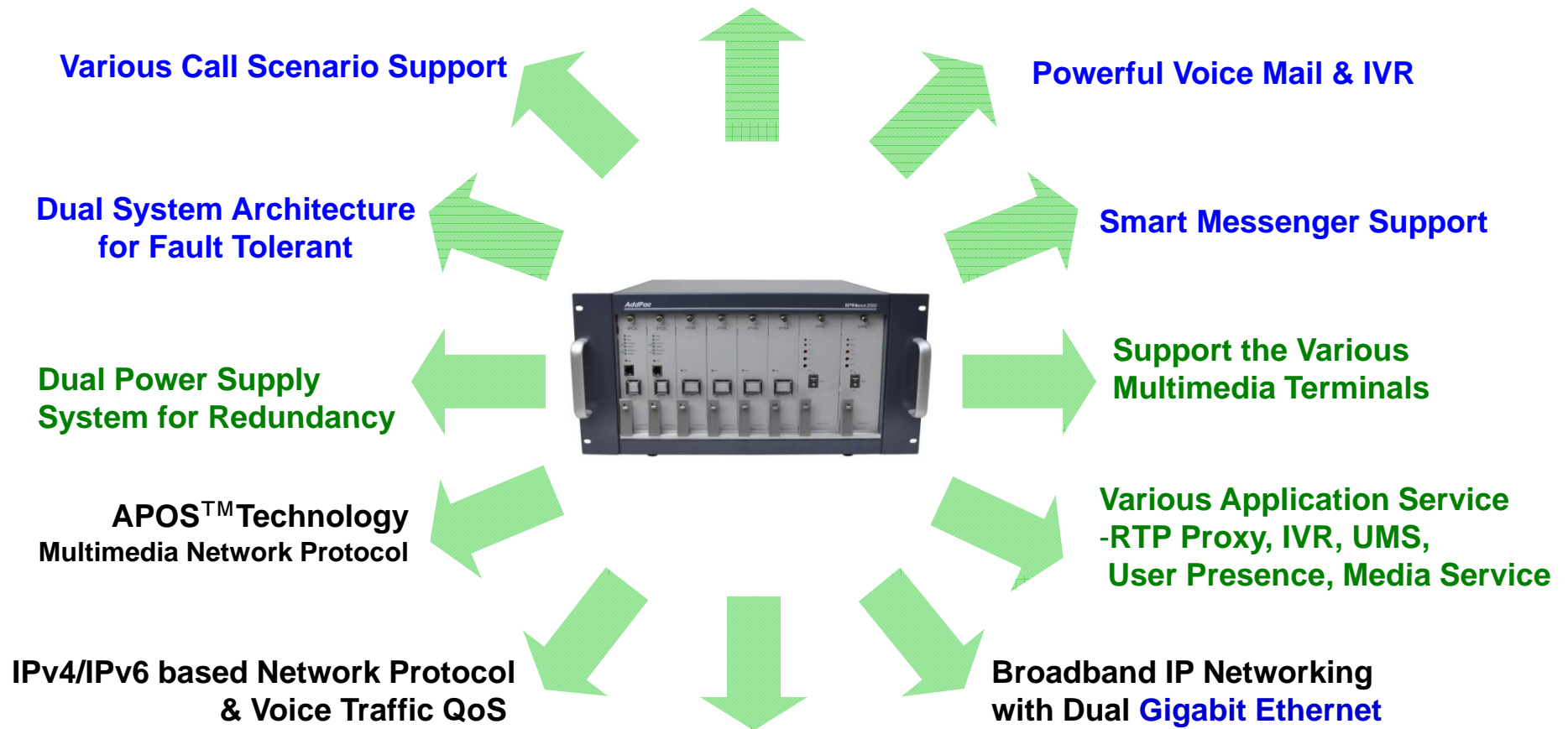

AddPac

www.addpac.com

Hardware Specification

IPNext2000 Next Generation IP-PBX System

A square logo with a dark blue background and a white border. The text "RISC" is positioned above "CPU" in white, sans-serif, uppercase letters.

RISC
CPU

- 64bit High-End Microprocessor Computing Power
- Main Chassis
 - Dual Redundancy CPU Boards for System Fault Tolerant
 - Two(2) 10/100/1000Mbps Gigabit Ethernet
 - One(1) RS-232C Console (RJ45)
 - Two(2) 3.5 Inch Hard Disk Interface Slot (RAID 1)
 - Dual Redundancy Power Supply Module
 - Hot-Swap Features

Hardware Specification

IPNext2000 Next Generation IP-PBX System



IPNext2000 Front Side

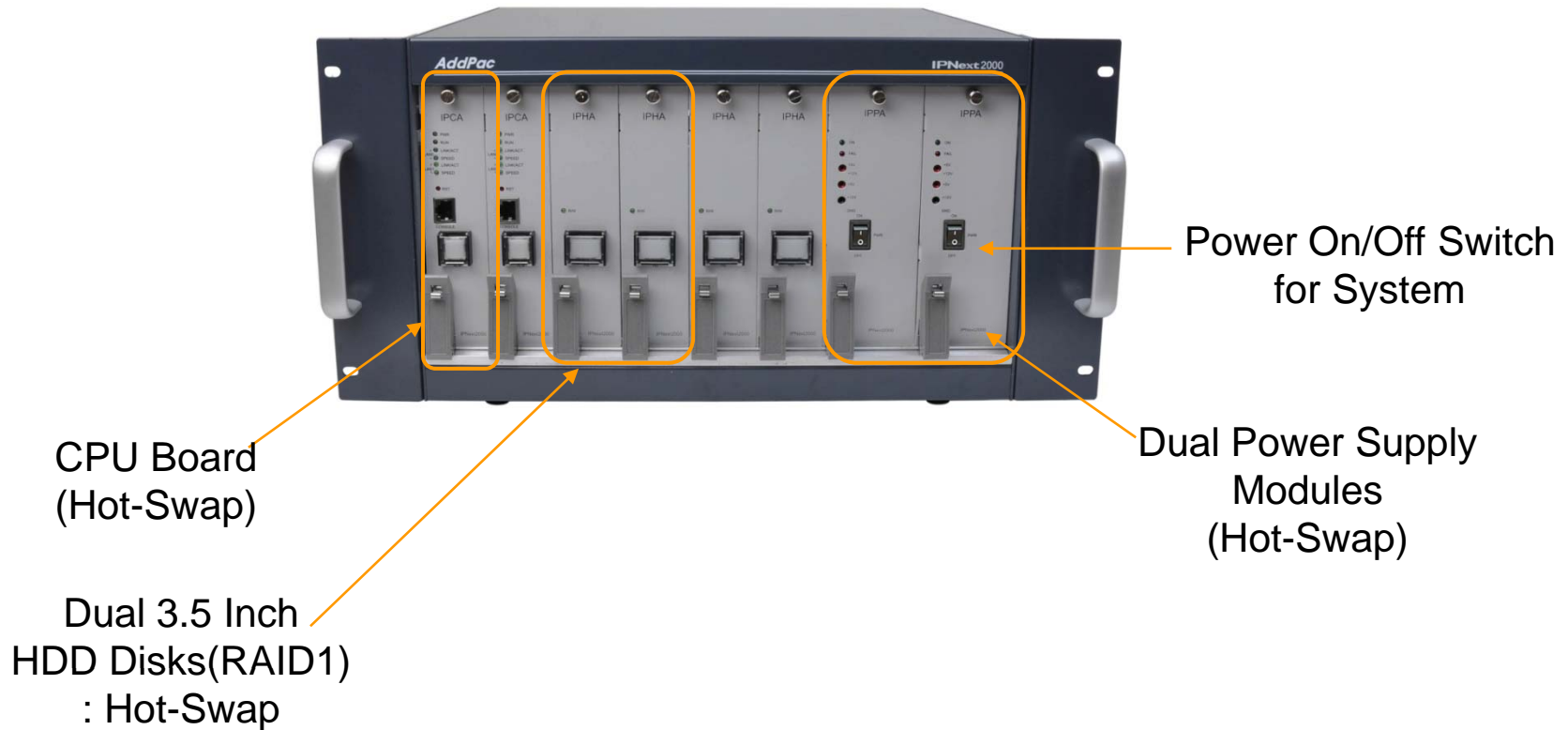

Hardware Specification

IPNext2000 Next Generation IP-PBX System

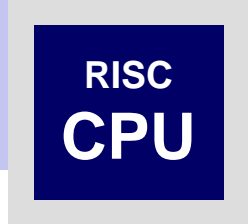

IPNext2000 Back Side

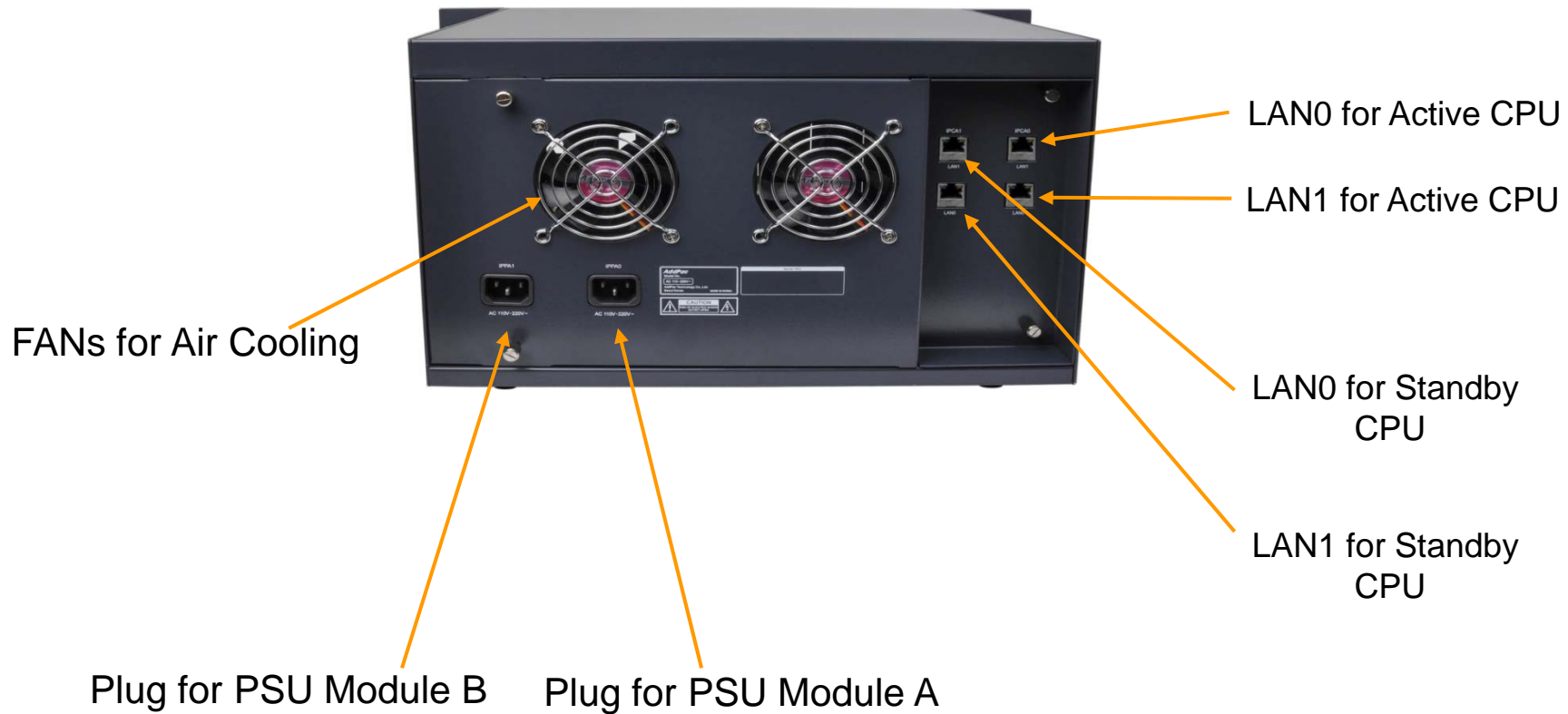

System Redundancy Features

IPNext2000 Next Generation IP-PBX System

IPNext2000 System Block Diagram

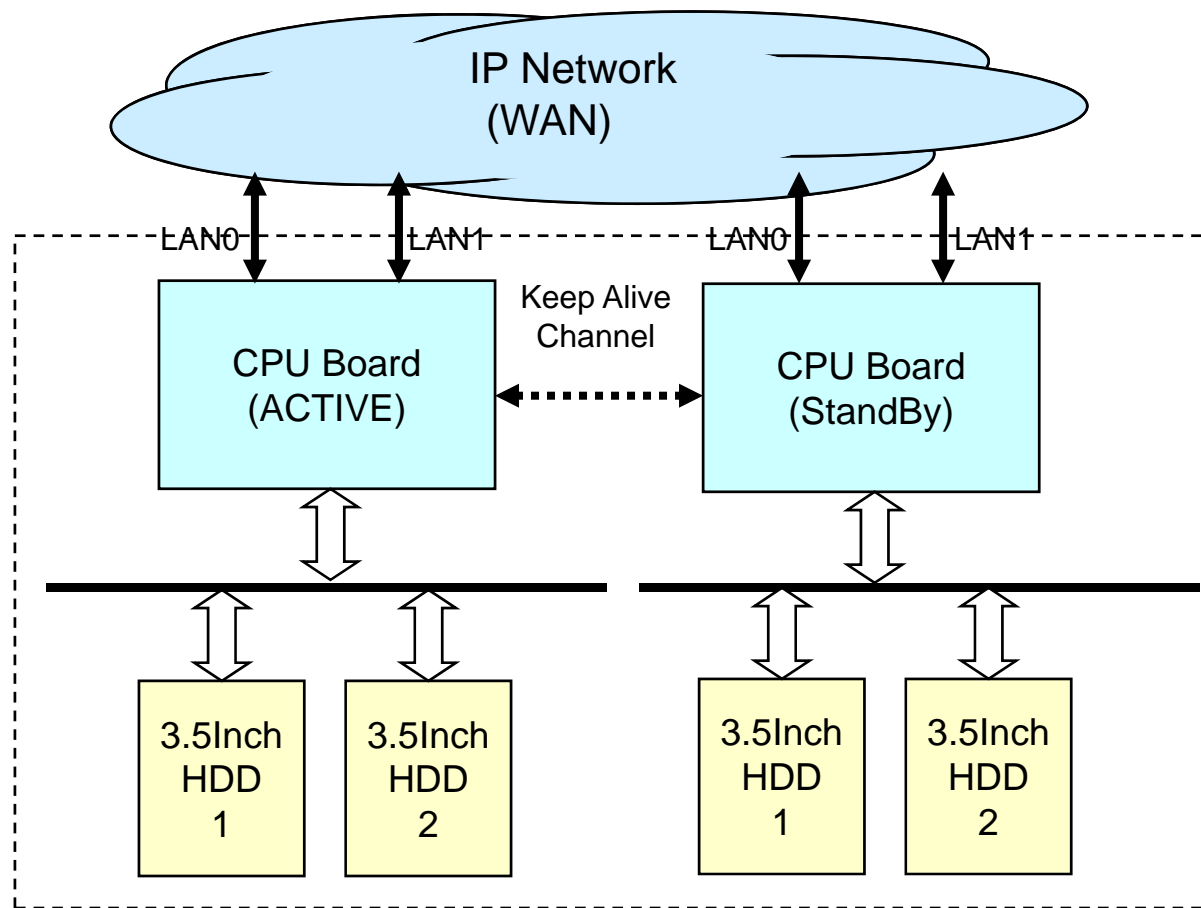

System Redundancy Features

IPNext2000 Next Generation IP-PBX System

- Active– Active Duplication Scheme
- Active – Standby Duplication Scheme
- VRRP based Duplication Scheme

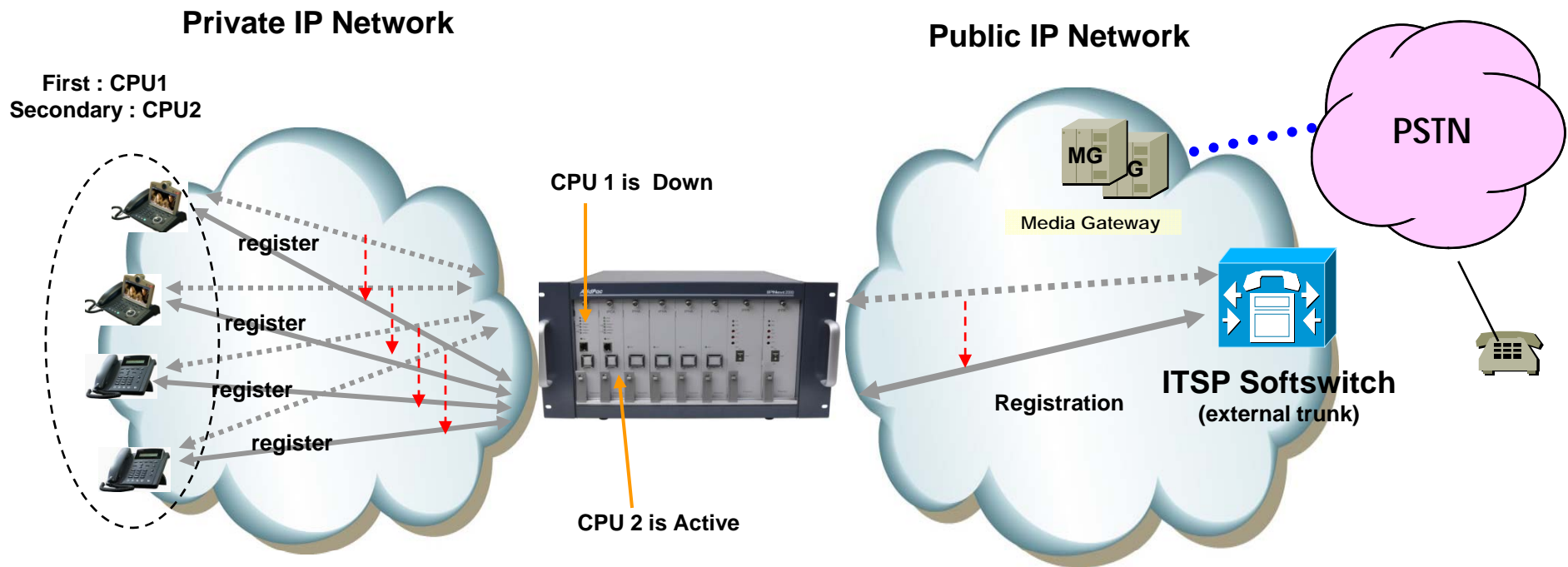

Active – Standby Duplication Scheme (example)

Software Service

IPNext2000 Next Generation IP-PBX System

- **Built-in AddPac APOS Internetworking Software**

- Scalability, Functionality, and Stability Features
- Advanced IP-PBX Call Manager Features
- QoS Control Features

- **Programmable Video, Audio, and Voice Services**

- Audio, Video and Voice Codec

- **Firmware Upgradeable Architecture**

- **Industry Standard Network Protocol Features**

- **Highly User Friendly Management Features**

- PC based Smart Messenger
- Smart Multimedia Manager for Operation & Management

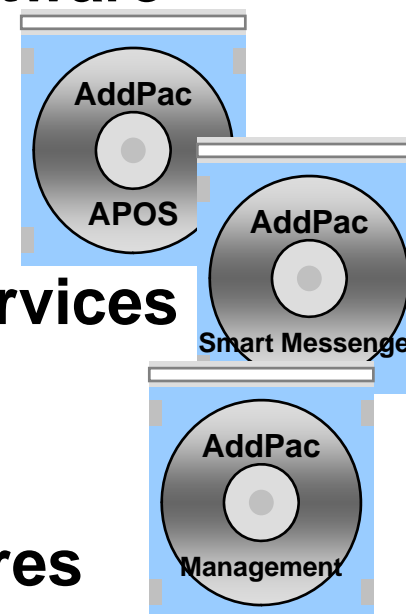

IP-PBX Software Components

IPNext2000 Next Generation IP-PBX System

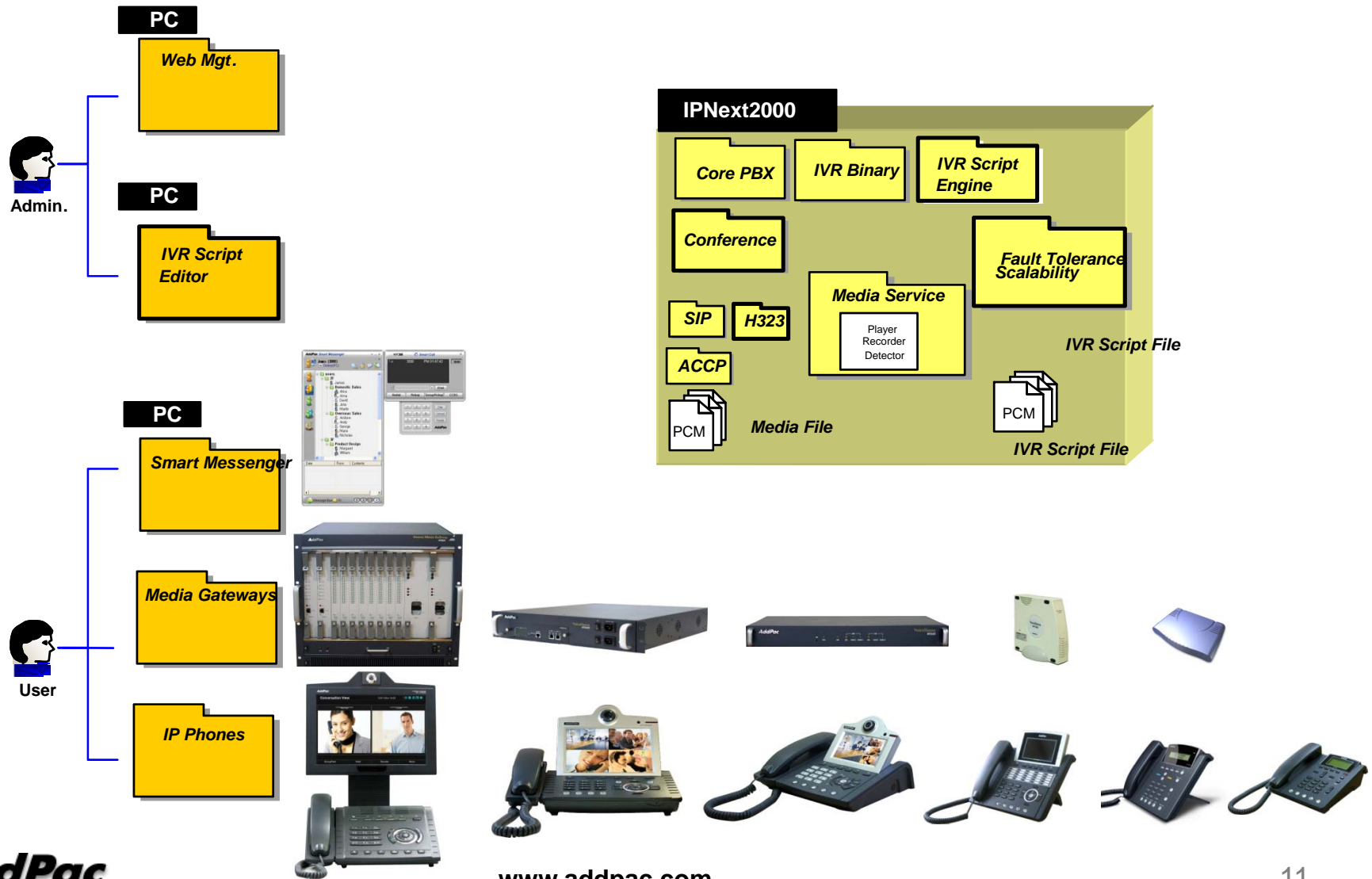

AddPac

www.addpac.com

IP Telephony Service and Features

IPNext2000 Next Generation IP-PBX System

- **Signaling Server**

- SIP Application Server, Proxy, Registrar and Location Server (RFC3261)
- Multiple ITSP Trunk with SIP & H.323 Accounts Support
 - IP UA Client Role for Registering to ITSP SIP Server
 - H.323 Gatekeeper Client Role for Registering to ITSP H.323 Gatekeeper Server

- **IVR & Auto Attendant**

- Default Auto Attendant Support
- Interactive Voice Response (IVR)
 - Provides with GUI-based Smart IVR Scenario Editor
 - Upload/Download Scenario by Smart IVR Scenario Editor
 - Supports Multiple Concurrent Scenarios
 - Supports Recordable IVR Prompts

- **Voice Mail**

- Support Voice Mail with IVR
- Access from Remote Site via Trunk Support
- Voice Mail Notification Support

IP Telephony Service and Features

IPNext2000 Next Generation IP-PBX System

- **Number & Call Routing**

- Trunk Hunting by Preference or Sequential
- Call Hunting by Preference, Simultaneous, Random
- Call Hunting by Chained Hunting Group
- Partition for Address Grading
- Call Class for Call Access Control
- Number Translation Rule for Inbound/Outbound Call
- Centrex with Prefix Support
- Multiple Shared Devices with One Number
- Multiple Numbers on One Device
- Individual Call Park within Park Number Pool
- Group Call Park within a Group or Other Group
- Call Pickup of Ringing Call of Same Group or Other Group
- Call Pickup of Parked Call
- Call Transfer - Blind, Consult
- Call Forwarding - Unconditional, Busy, No Answer, Voice Mail
- Call Waiting
- Call Swaping
- Call Hold

IP Telephony Service and Features

IPNext2000 Next Generation IP-PBX System

- **IP-PBX Advanced Features with AddPac IP Phones**

- Multiple Call Handling with Call Status and Calling Line Number and Name
- Plug and Play with Auto Discovery Function
- Softkey Map Download and Control
- Time and Date Setting
- Voice Mail List View
- Parked Call List View
- Call Forward Setting
- Recent Call List View
- Calling Number and Name Identification
- Individual Call Park within Park Number Pool by Softkey
- Group Call Park within a Group or Other Group by Softkey
- Call Pickup of Ringing Call of Same Group or Other Group by Softkey
- Call Pickup of Parked Call by Softkey
- Call Transfer - Blind, Consult by Softkey
- Call Waiting Indication
- Call Swaping by Softkey
- Call Hold by SoftKey
- Conference Control

IP Telephony Service and Features

IPNext2000 Next Generation IP-PBX System

- **User & Device Management**

- LDAP (Light weight Directory Access Protocol) Support
 - Supports Hierarchical Organization
- Auto Discovery of IP Phones & Video Phones
- Monitoring Status of Phones

- **Miscellaneous***

- Distinctive Ring by Calling User
- Auto Config & Upgrade
- Personal Directory
- Downloadable Ring
- Do not Disturb



IP Telephony Service and Features

IPNext2000 Next Generation IP-PBX System

- **Conference**

- G.711 (4-party Conference, 2 session) : Basic
- Ad-hoc Conference
- Dial-Out Conference
- Meet-me Conference
- Multiple External MCU support(Video, Audio, etc) : AddPac AP-MC1000, etc
- Conference Chair and Participants Management

- **Music & Announcement**

- Music on Hold
- Replaceable Announcements
- Dialing Music / Tone Service

IP Telephony Basic Call Scenario

IPNext2000 Next Generation IP-PBX System

IPNext2000 IP-PBX

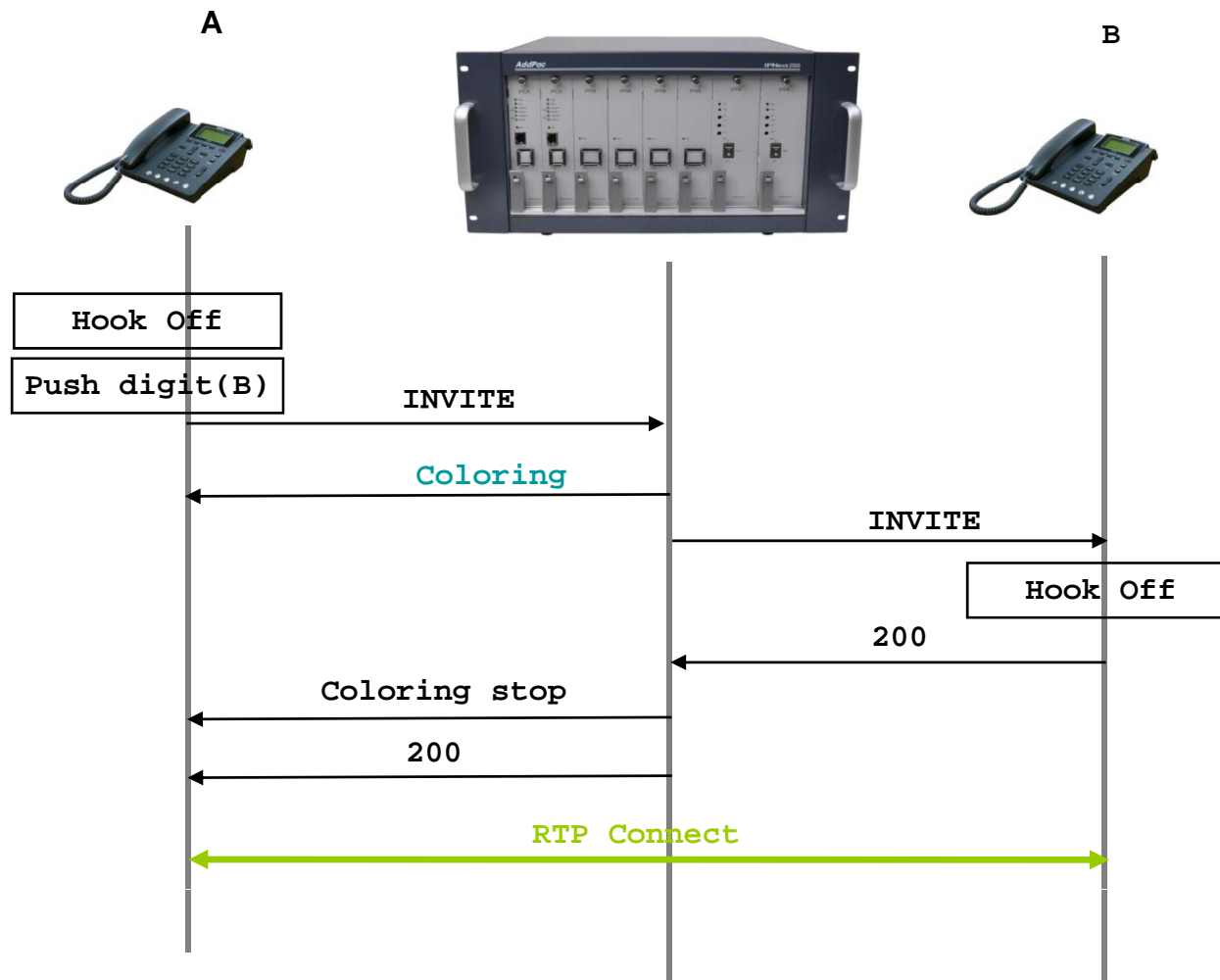

RTP Proxy Service

IPNext2000 Next Generation IP-PBX System

Public/Private RTP Proxy
without NAT Router

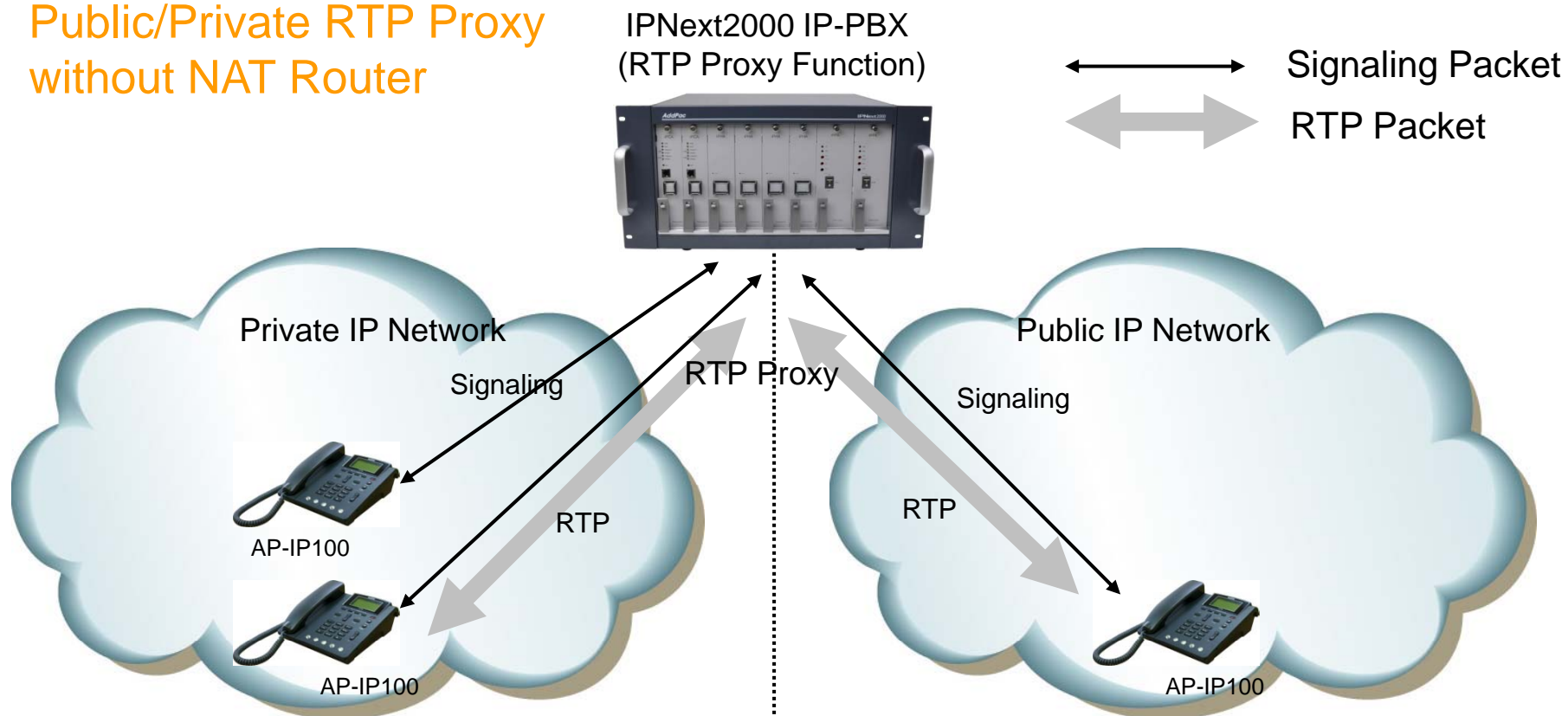

- Located between public and private network
- IPNext2000(Call manager + RTP proxy) has public and private address
- IPNext2000 determine that the call is internal or external

RTP Proxy Service

IPNext2000 Next Generation IP-PBX System

Asymmetric/Symmetric NAT

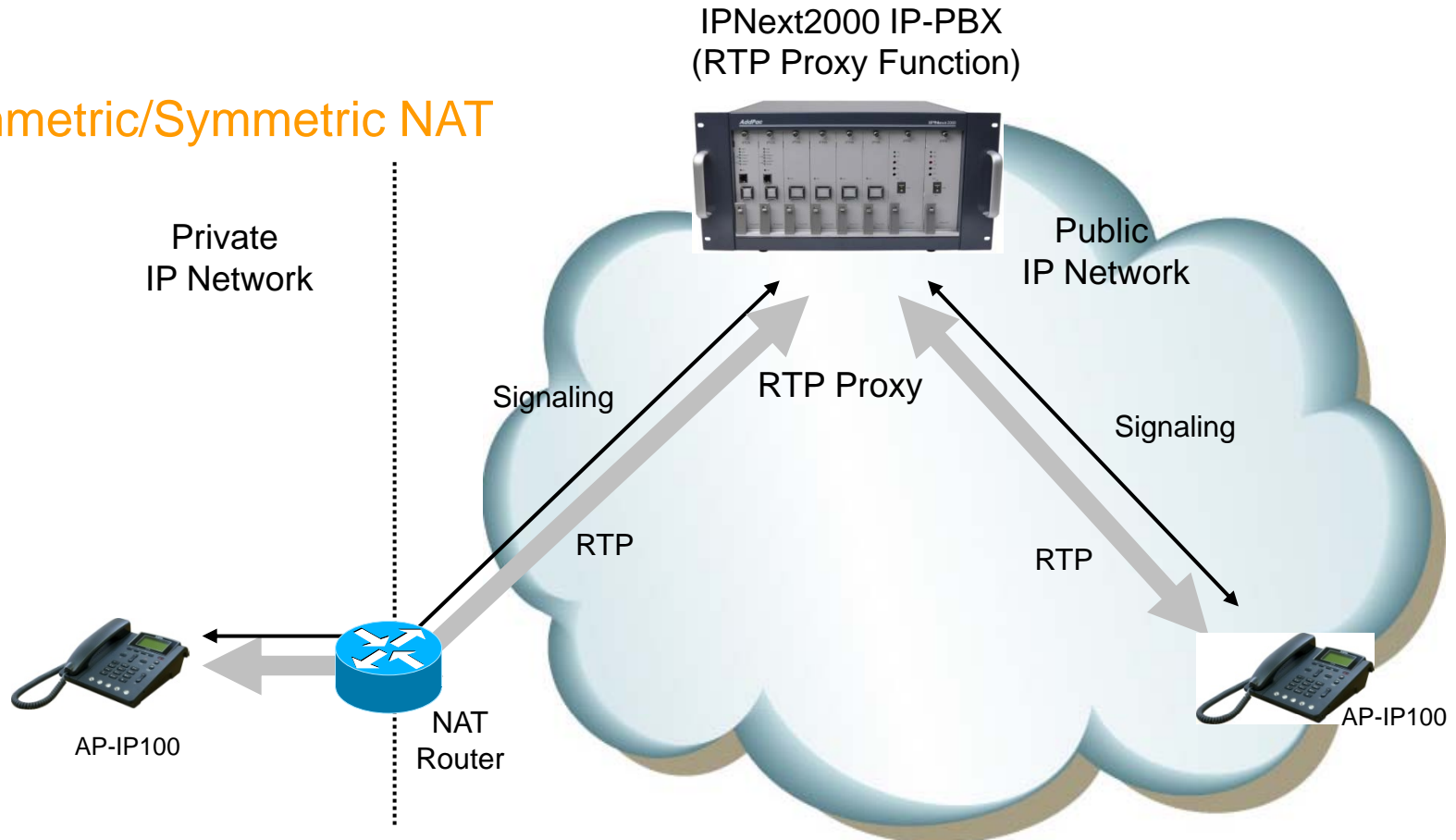

- Located in public network
- RTP Proxy has single public address
- Auto detect for asymmetric NAT via incoming RTP packet

www.addpac.com

RTP Proxy Service

IPNext2000 Next Generation IP-PBX System

RTP Proxy Communication between Private IP

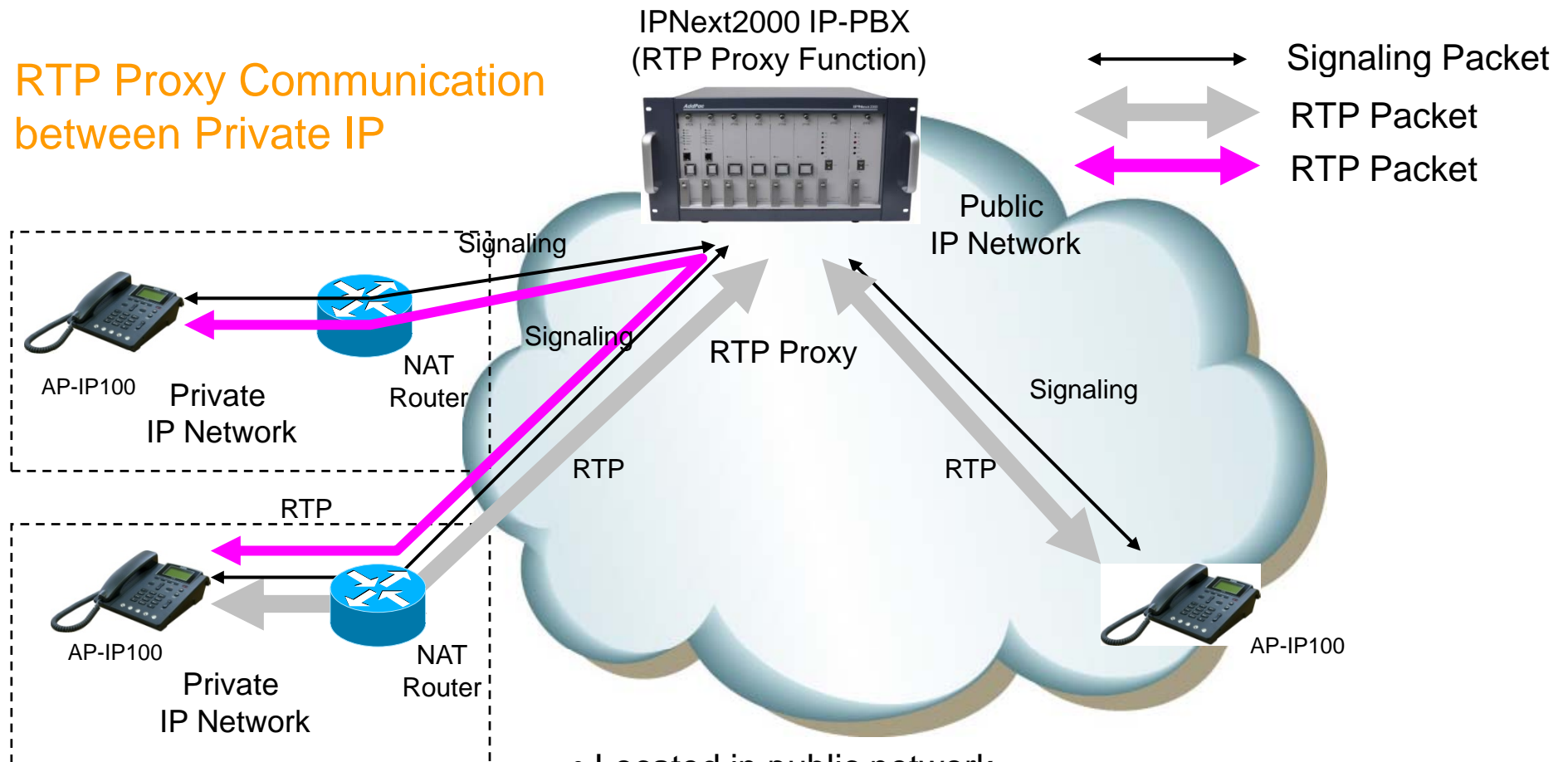

- Located in public network
- RTP Proxy has single public address
- Auto detect for asymmetric NAT via incoming RTP packet

RTP Proxy Service

IPNext2000 Next Generation IP-PBX System

IPv4/IPv6 RTP Proxy

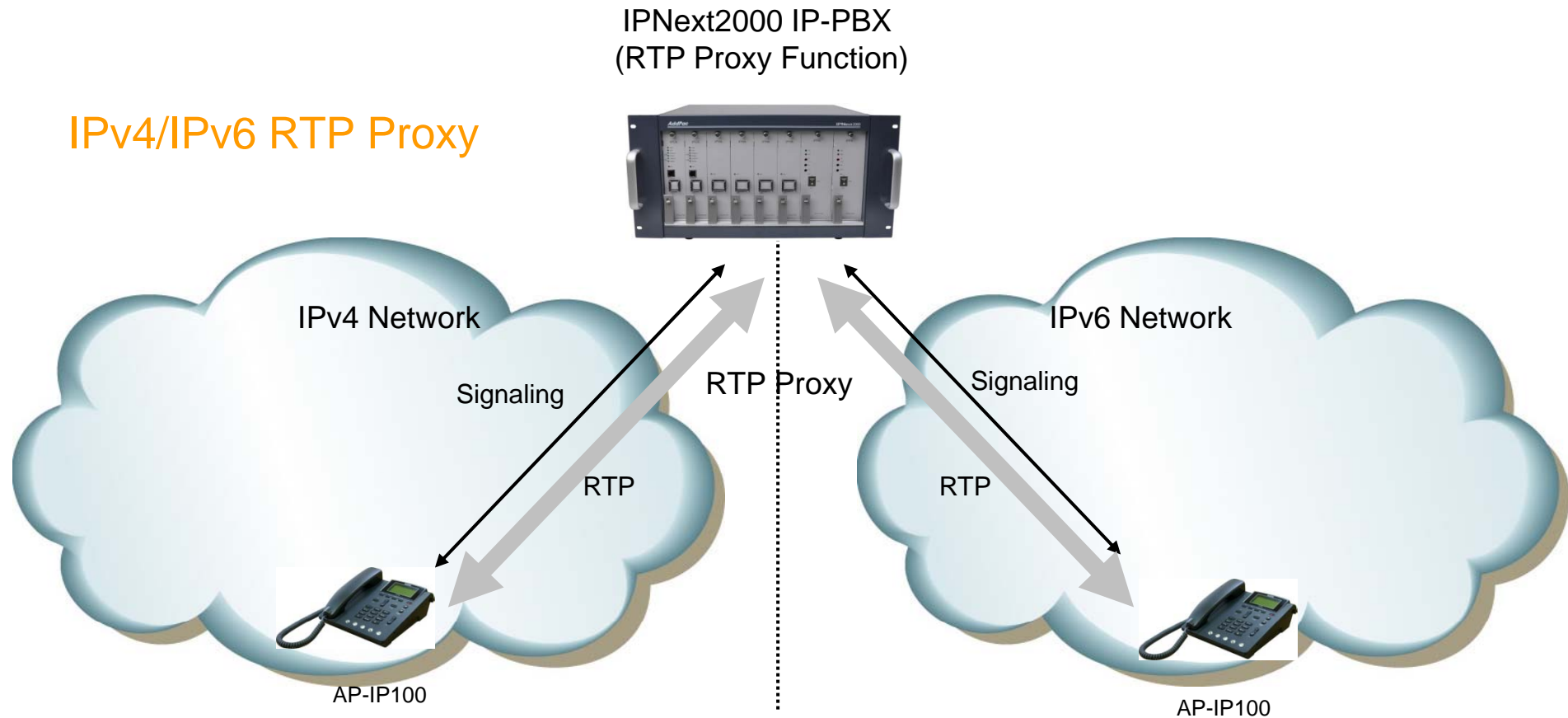

- IPNext2000(Call manager + RTP proxy) has IPv4 and IPv6 address

User Presence Service for UC

IPNext2000 Next Generation IP-PBX System

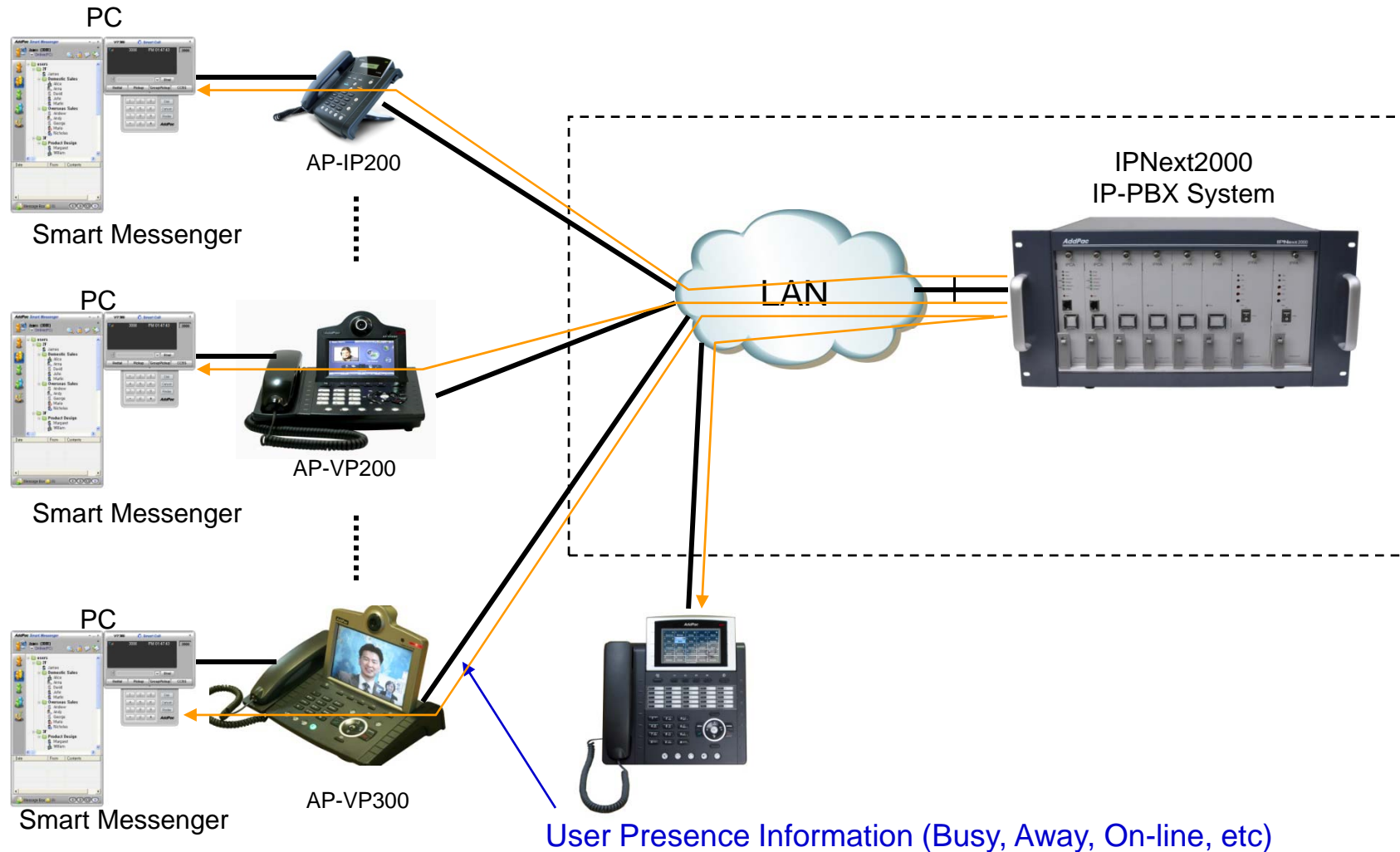

Network Service and Features

IPNext2000 Next Generation IP-PBX

- **Basic Network Protocols**
 - ARP, IP, IPv6, TCP, UDP, ICMP, ICMPv6, SCTP, IGMP, MLD
- **Routing Protocol**
 - IPv4 : Static
 - IPv6 : Static
- **Service Protocol**
 - FTP, Telnet, TFTP, DHCP Server/Relay, SNMP Server
 - CDP (Cisco Discovery Protocol)
 - DNS Resolver , DDNS(nsupdate)
 - Bridge
 - Syslog
 - IP/IPv6 policy control (QoS)
 - VPDN (Virtual Private Dial-up Network : L2TP Server)

Network Service and Features

IPNext2000 Next Generation IP-PBX

- **IPv4/IPv6 Interworking**
 - NAT/PAT for IPv4
 - IP connect (formerly ip-share) and device cascade for IPv4
 - IP/IP, IP/GRE tunneling
 - NAT-PT
 - 6to4, Autoconfig tunneling
- **IPv4 Address Configuration**
 - Fixed (Static)
 - DHCP
 - PPPoE
- **IPv6 Address Configuration**
 - Fixed (Static)
 - EUI-64
 - Autoconfig (Neighbor Advertisement and Solicitation)

Network Service and Features

IPNext2000 Next Generation IP-PBX

- **Miscellaneous**

- Standard & Extended IPv4/IPv6 Access List
- Multi-level User Account Management
- IP accounting
- fsh (Embedded file system shell)
- STUN Client

Network Service and Features

IPNext2000 Next Generation IP-PBX

SNMP MIBs

- MIB-II
- RMON MIBs (Statistics, History, Alarm, Hosts Group)
- RFC2465 Management Information Base for IP Version 6: Textual Conventions and General Group
- RFC2466 Management Information Base for IP Version 6: ICMPv6 Group
- RFC2452 IP Version 6 Management Information Base for the Transmission Control Protocol
- RFC2454 IP Version 6 Management Information Base for the User Datagram Protocol
- AddPac Enterprise MIBs
- etc



AddPac IP Terminals

AddPac IP Terminals

- AP-VP500 Video Phone
- AP-VP350 MCU Video Phone
- AP-VP300 Video Phone
- AP-VP280 Video Phone
- AP-VP250 Video Phone
- AP-VP230 Video Phone
- AP-VP150 Video Phone
- AP-VP120 Video Phone
- AP-IP300 IP Phone
- AP-IP250 IP Phone
- AP-IP230 IP Phone
- AP-IP160 IP Phone
- AP-IP120 IP Phone
- AP-IP90 IP Phone
- AP-WP100 Wi-Fi Phone
- AP-SMP100 Soft Phone



AP-VP500



AP-VP300



AP-VP150



AP-WP100



AP-VP120



AP-IP300



AP-IP230



AP-IP160









AP-IP120



IP Video Phones for AddPac IP-PBX



IP Video Phones for AddPac IP-PBX

	AP-VP500	AP-VP350	AP-VP300N	AP-VP280	AP-VP250	AP-VP230	AP-VP150	AP-VP120
								
LCD Size	12.1 Inch Touch Screen	7Inch Touch Screen	7Inch Touch Screen	7Inch Touch Screen	4.3Inch Touch Screen	5Inch Touch Screen	4.3Inch Touch Screen	4.3Inch
Camera	CCD	CCD	CCD	CMOS	CMOS	CMOS	CCD	CMOS
Video Codec	H.263 MPEG4 H.264	H.263 MPEG4 H.264	H.263 MPEG4 H.264	H.263 MPEG4 H.264	H.263 MPEG4 H.264	H.263 MPEG4 H.264	H.263 MPEG4 H.264	H.263 MPEG4 H.264
Signaling	H.323/SIP	H.323/SIP	H.323/SIP	H.323/SIP	H.323/SIP	H.323/SIP	H.323/SIP	H.323/SIP
Video MCU	N/A	4-Party Video MCU	N/A	N/A	N/A	N/A	N/A	N/A
Voice MCU	3-Party	3-Party	3-Party	3-Party	3-Party	3-Party	3-Party	3-Party
LAN Port	2	2	2	2	2	2	2	2
PoE	N/A	N/A	Support	Support	Support	Support	Support	Support



IP Phones for AddPac IP-PBX



IP Phones for AddPac IP-PBX

	AP-IP300	AP-IP250	AP-IP230	AP-IP160	AP-IP120	AP-IP90
						
LCD Size	4.3 Inch Color LCD	4.3 Inch Color LCD	5 Inch Color LCD	4 Text Line Graphic LCD	4 Text Line Graphic LCD	4 Text Line Graphic LCD
Touch Screen	N/A	Support	Support	N/A	N/A	N/A
Speed-Dial Keys	25 Key with Presence LED	Touch Screen based 25 Keys	Touch Screen based 25 Keys	16 Key with Presence LED	12 Key with Presence LED	N/A
Voice Codec	G.711/G.726/G.729/G.723	G.711/G.726/G.729/G.723	G.711/G.726/G.729/G.723	G.711/G.726/G.729/G.723	G.711/G.726/G.729/G.723	G.711/G.726/G.729/G.723
Signaling	H.323/SIP	H.323/SIP	H.323/SIP	H.323/SIP	H.323/SIP	H.323/SIP
3-Party Conversation	Support	Support	Support	Support	Support	Support
LAN Port	2	2	2	2	2	2
PoE(Optional)	Support	Support	Support	Support	Support	Support
FXO(Optional)	Support	Support	Support	Support	Support	Support



IP Extend Key Pack for AddPac IP-PBX

IP Extend Key Pack Comparison Table

Model	AP-PT100	AP-PT50	AP-PT20
Service Features			
Key Type	7 inch LCD Touch Screen	Push Button with User Presence Indication LAMP	Push Button with User Presence Indication LAMP
Key Number	Default : 9(row) x 4(column) = 36	60 Key	40 Key
User Presence Indication	Support	LED on, LED off, LED Blink	LED on, LED off, LED Blink
Multiple Cascading	Support	Support	Support
Speaker	Support	Support	Support
LAN Port	2	2	2
PoE(Optional)	Support	Support	Support
Application	IP Phone or Video Phone Extend Key Pack	IP Phone or Video Phone Extend Key Pack	IP Phone or Video Phone Extend Key Pack

IP Wifi Phone

AP-WP100 IP Wifi Phone

- Wi-Fi IP Phone Solution
- Various Call Scenario Support (IP-PBX)
- State-of-art SIP Signaling
- IEEE802.11b/g up to 54Mbps
- WPA(Wifi Protected Access), 802.11i Security Standard
- Wi-Fi IP Audio Broadcasting Terminal Solution
- External Audio In/Out Port for Headset
- Firmware Upgradeable Architecture
- VoIP Solution with Outstanding Network Service Capability
- Audio Privacy Protection



Smart Communicator

AP-SMP100 Soft Phone (Video/Voice)

- MS-Window based Soft-Phone
- Smart Multimedia (Video/Voice) Soft-Phone
- IP Real-time Audio/Video Broadcasting Terminal Solution
- Built-In Smart Messenger Function
- Up to 30fps with VGA-Resolution(MPEG-4)
- Video Conference Call Support (AddPac External MCU Inter-working)
- Advanced Voice/Video Traffic QoS
- SIP, H.323* Signaling Support
- Support Various Call Signal via AddPac IP-PBX Inter-working

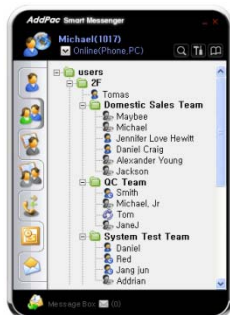

Smart Messenger

- MS-Window based Application
- Support Messenger Service
- Support Various Address Book
- Support User Presence Information
- Support User Search Feature
- Interoperation with Address Book and Smart Phone
- Support Smart Phone Control and Setup
 - Call Control and Forward Setup
- Support Unified Message Box
 - Voice Mail Box
 - Short Message Box



AP-VP300



AP-VP280



Smart Messenger

Smart Window(1/2)

Smart Window is simple web based personal information management program for IP-PBX, Call Manager, etc.

Service Features

- User Information
 - Personal information configuration
- Alarm
 - Alarm event configuration
- User Search
 - User search using search keyword
- Call Forwarding
 - Call forwarding configuration
- Speed Dial
 - Speed dial configuration
- Conference*
 - Configuration of audio, video multiparty conference

Smart Window (2/2)

Main Layout of Smart Window consists of Menu, Contents, Help Message, etc.

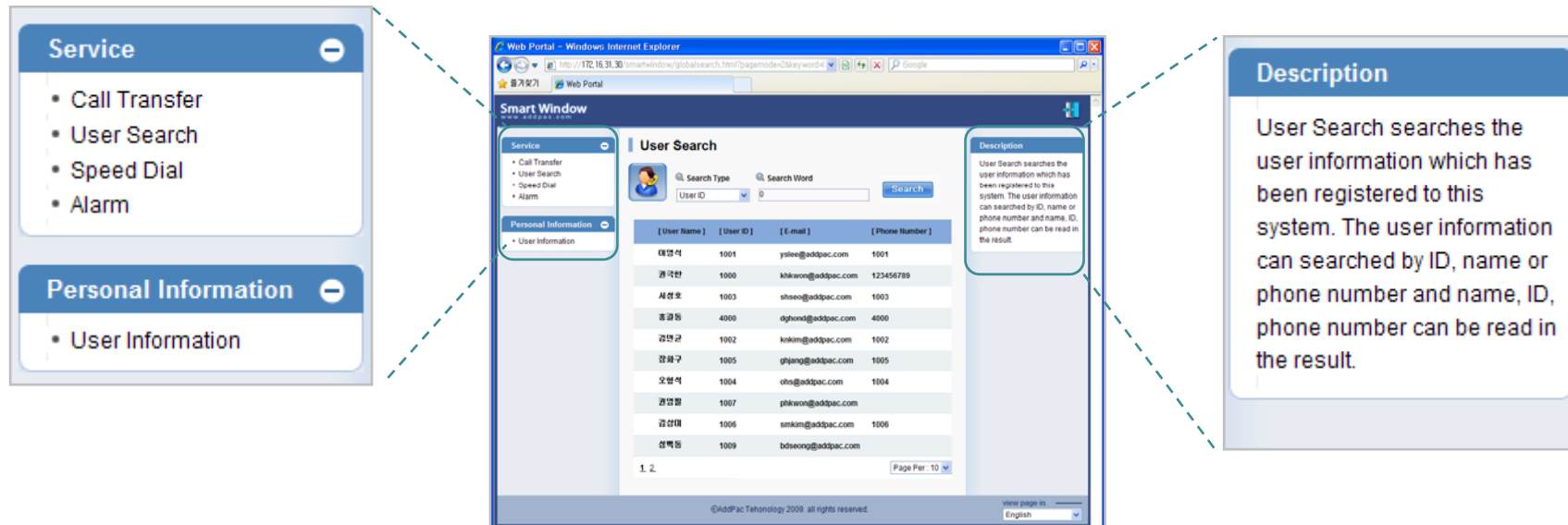

Main Menu

Main Layout

Help Message

Standard IP-PBX System Application

IPNext2000 Next Generation IP-PBX System

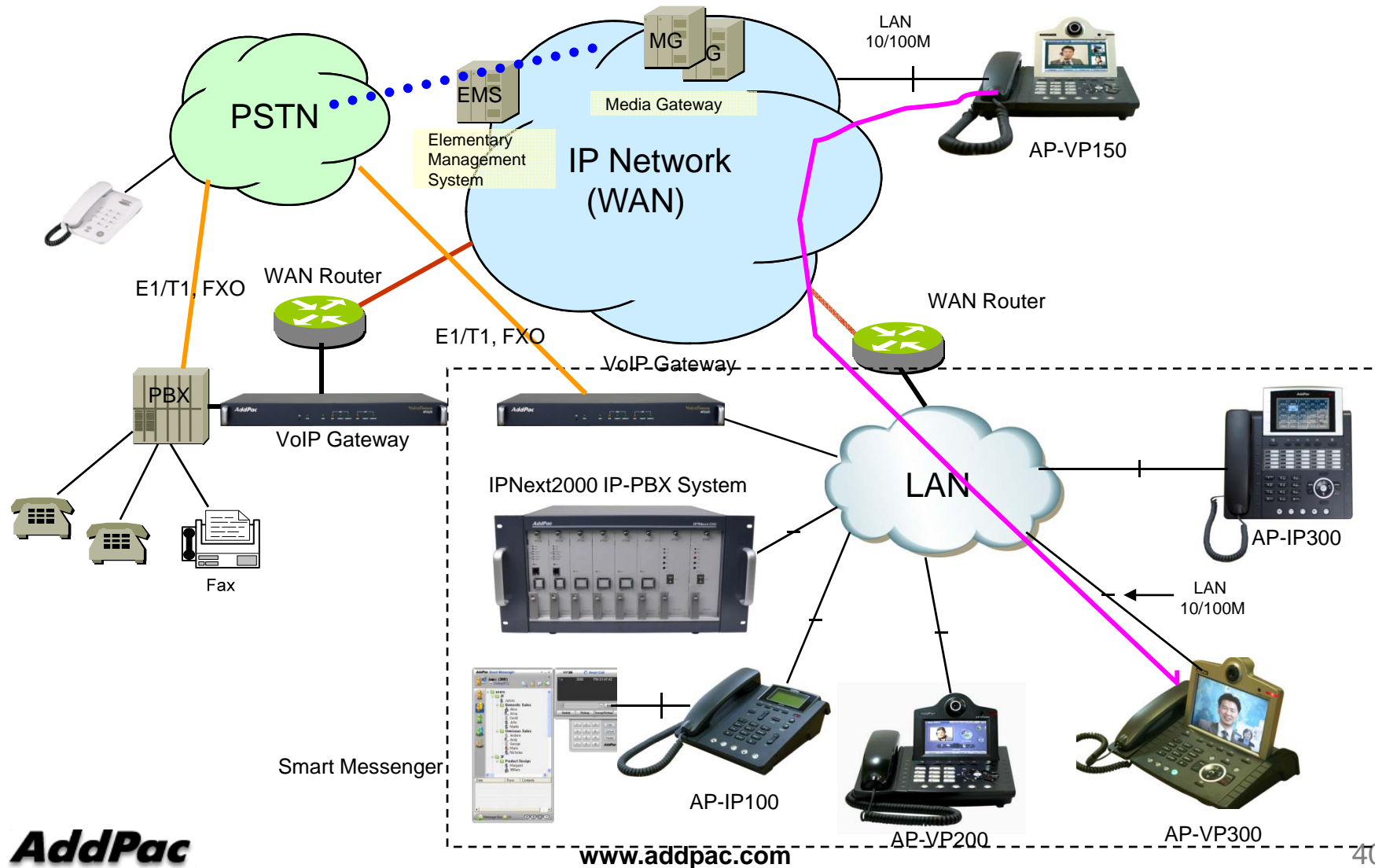

Ordering Information

- **IPNext 2000 Next Generation IP-PBX Hardware**
 - IPNext2000 IP-PBX Main Body
 - High-performance 64bit RISC CPU
 - High-End 64bit CPU board (Hot-Swap)
 - 2-ports Fast Ethernet and 1-port RS-232C Console
 - Including Network Cable Set & Ext. Power Supply, etc.
 - Power Supply Module (Hot-Swap)
 - Additional CPU board for Fault Tolerant (option)
 - Additional Power Supply Module for Redundancy (option)
- **Built-in APOS Internetworking Software for IPNext2000**
- **Including 1 Year Hardware Warranty**
- **Product Documents**
 - Install and Operation Guide (PDF)
- **Pricing**
 - AddPac Technology Regional Sales Manager
 - Authorized Sales and Marketing Representatives
 - Please Contact www.addpac.com



Thank you!

AddPac Technology Co., Ltd.
Sales and Marketing

Phone +82.2.568.3848 (KOREA)

FAX +82.2.568.3847 (KOREA)

E-mail sales@addpac.com