

# IPNext350™

## NGN Hybrid IP-PBX System

High-performance Next Generation Hybrid IP-PBX System

Preliminary Product Overview



**AddPac**

**AddPac Technology**

2012, Sales and Marketing

[www.addpac.com](http://www.addpac.com)

# Contents

- Product Overview
- Hardware Specification
- Software Service
- Hybrid IP-PBX Service and Features
- RTP Proxy Service
- User Presence Service
- Network Service and Features
- IP Multimedia Terminals
- Application Area
- Ordering Information

# Product Overview

## IPNext350 Hybrid IP-PBX System

- IP based Advanced Hybrid IP-PBX Solution
- IPv4/IPv6 Multimedia Telephony Solution for Medium Office
- PSTN Interface (FXO, FXS, etc) Support
- Up to 256 Port Analog Channel Support
- Powerful Management and User Friendly Features
- Fault Tolerant and Scalability Architecture
- High-performance Video, Audio, and Voice Service
- Firmware Upgradeable Architecture
- IVR Service with Scenario Editor
- Voice Mailing Service
- Presence Service for High-End IP Phone, UC
- RTP Proxy Service for Private IP service
- SIP, H.323 Signaling for Outbound Calls
- Various Call Scenario (Call Pickup, Call Park, Call Transfer, etc)
- Various IP Terminal Support

# Product Highlights

IPNext350 Hybrid IP-PBX System

## IP based Advanced Hybrid IP-PBX System

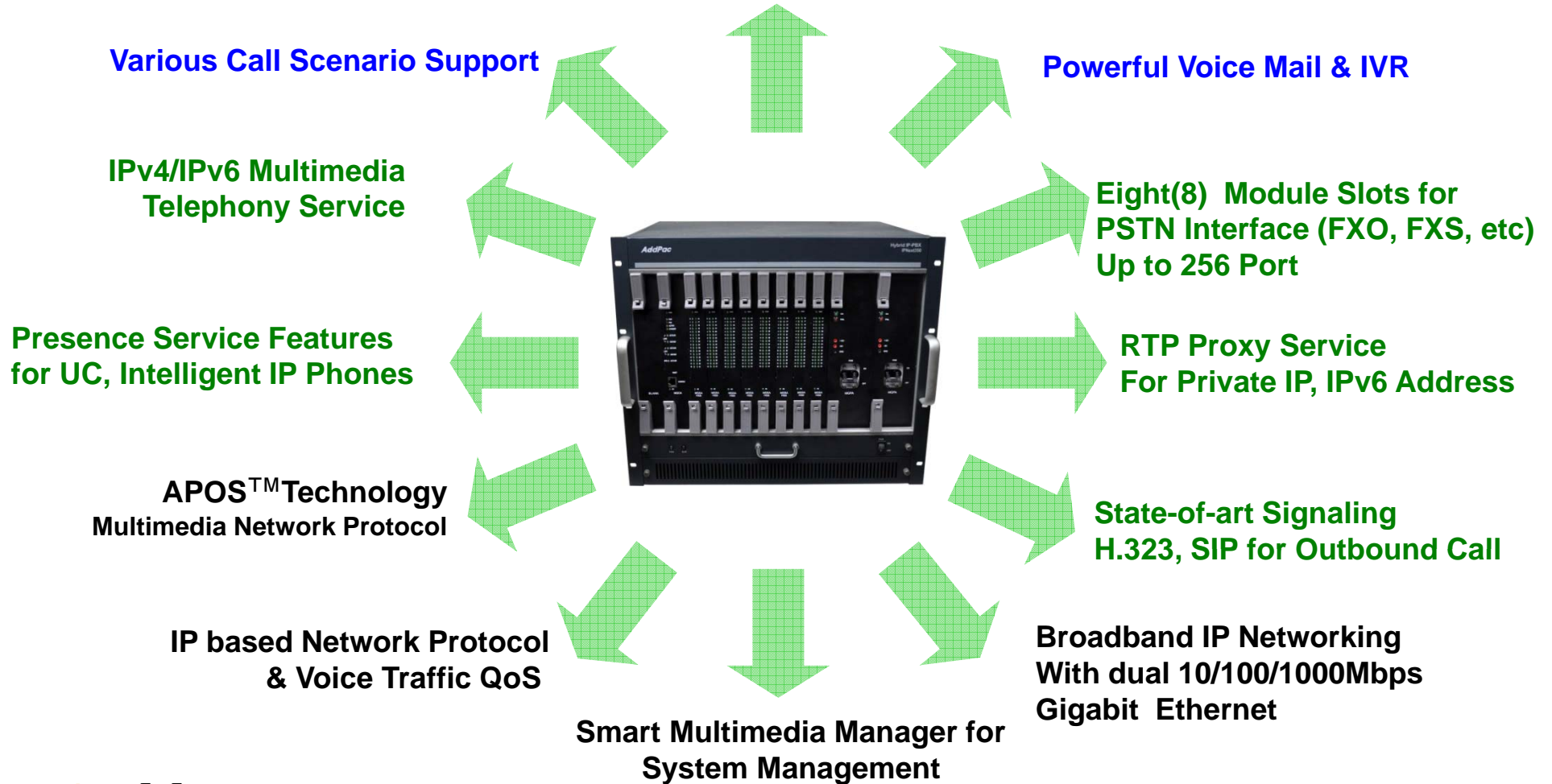

[www.addpac.com](http://www.addpac.com)

**AddPac**

# Hardware Specification

## IPNext350 Hybrid IP-PBX System

RISC  
CPU

High-end  
DSP

IPNext350 Hybrid IP-PBX System	Basic Specifications
PSTN Voice Interface	Eight(8) VoIP Module Slots (32-Port Analog FXS Board, FXO Board, etc)
	Up to 256 Analog Channel Support
	MGSA-FXS32, MGSA-FXS32-N1, MGSA-FXS32_N2, MGSA-FXO32, etc
Ethernet Interface	2-Port 10/100/1000Mbps Gigabit Ethernet Interface(RJ-45)
Flash Memory	512Mbyte/1Gbyte NAND Flash Memory
Main Memory	1Gbyte High Speed DDR2
Power Requirement	VAC 110~220V, 50/60Hz, 12V/60A, 5V/30A Default : Single Power Supply Option : Dual Power Supply for Redundancy Option : AC Power Supply, DC Power Supply
Operating Temperature	0°C ~ 45°C (32 °F ~ 122°F)
Storage Temperature	-40°C ~ 85°C (-40°C ~ 185°F)
Relative Humidity	5% ~ 95% (Non-condensing)
Dimension (H x W x D)	400mm × 482mm × 340mm
Weight	30.5Kg

# Hardware Specification

IPNext350 Hybrid IP-PBX System

RISC  
CPU

High-end  
DSP

- RISC Microprocessor Computing Power
- Main Chassis
  - Network Interface
    - Two(2) 10/100/1000Mbps Gigabit Ethernet
    - One(1) RS-232C Console (RJ45)
  - Eight(8) VoIP Module Slots for FXS, FXO, etc
  - Hot-Swap VoIP Module
  - Module Type Dual Power Supply for Redundancy

# Hardware Specification

IPNext350 Hybrid IP-PBX System

RISC  
CPU

DSP

Front Side

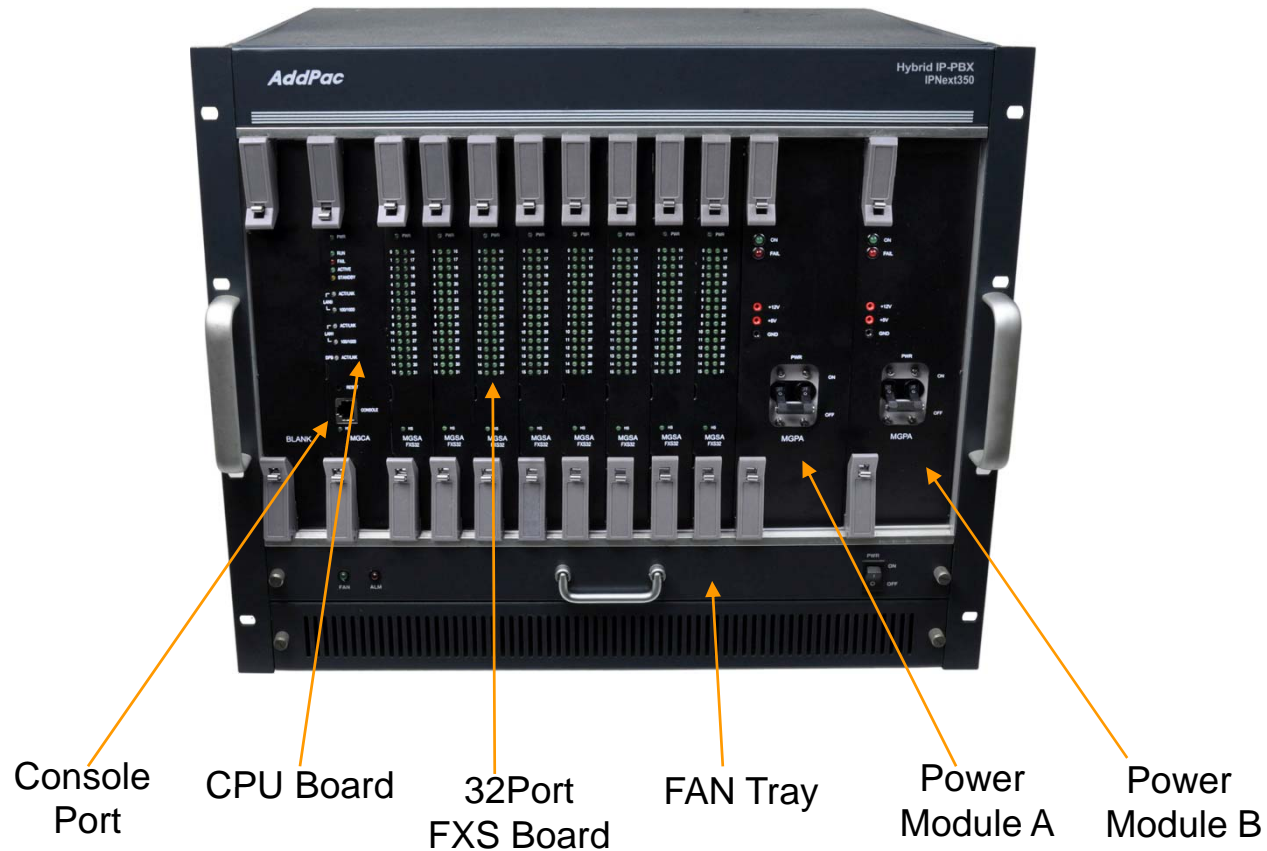

# Hardware Specification

IPNext350 Hybrid IP-PBX System

RISC  
CPU

DSP

## Back Side



AC Power  
Input

32-Port Analog Interface  
Champ Connector

Gigabit Ethernet  
Interface



# Hardware Specification

IPNext350 Hybrid IP-PBX System

RISC  
CPU

DSP

## MGCA

Media Gateway Control Board Assembly  
: CPU Board



## MGSA-32FXS

Media Gateway Subscriber Board Assembly  
: 32-Port FXS for Long Distance

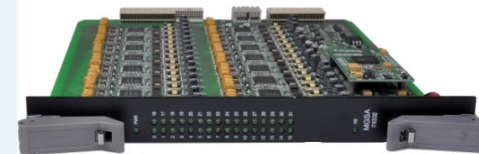

## MGSA-32FXS-N1

Media Gateway Subscriber Board Assembly  
: 32-Port FXS for Small & Medium Distance

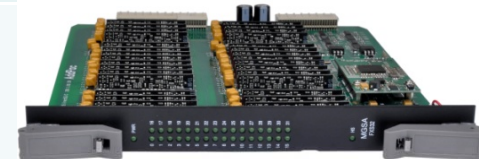

## MGSA-32FXS-N2

Media Gateway Subscriber Board Assembly  
: 32-Port FXS for Small & Medium Distance



## MGSA-32FXO

Media Gateway Subscriber Board Assembly  
: 32-Port FXO

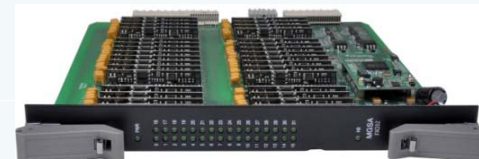



# Hardware Specification

IPNext350 Hybrid IP-PBX System

RISC  
CPU

High-end  
DSP

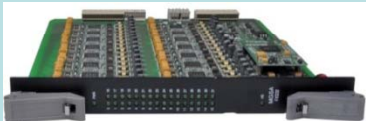
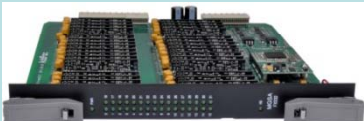
## MGSA-FXS32 VoIP Module Comparison

Product	MGSA-FXS32	MGSA-FXS32-N1	MGSA-FXS32-N2
			
Distance	Long Reachable Distance for Next Generation Network Service	Short & medium Reachable Distance	Short & medium Reachable Distance
Analog Ports	32 Port FXS Module	32 Port FXS Module	32 Port FXS Module
Connector	Champ Connector	Champ Connector	8 x RJ45 Connector
Caller ID	Support	Support	Support
Hot-Swap	Support	Support	Support
DSP based Voice Codec	G.711,G.729,G.723,etc	G.711,G.729,G.723,etc	G.711,G.729,G.723,etc
Ringing Voltage	Programmable : Typical 80Vrms	65Vrms	65Vrms
REN	5	3	3

# Hardware Specification

IPNext350 Hybrid IP-PBX System

RISC  
CPU

High-end  
DSP

## IPNext350 VoIP Module Combination Diagram

256-Port(32x8Module) FXS Gateway Service Diagram

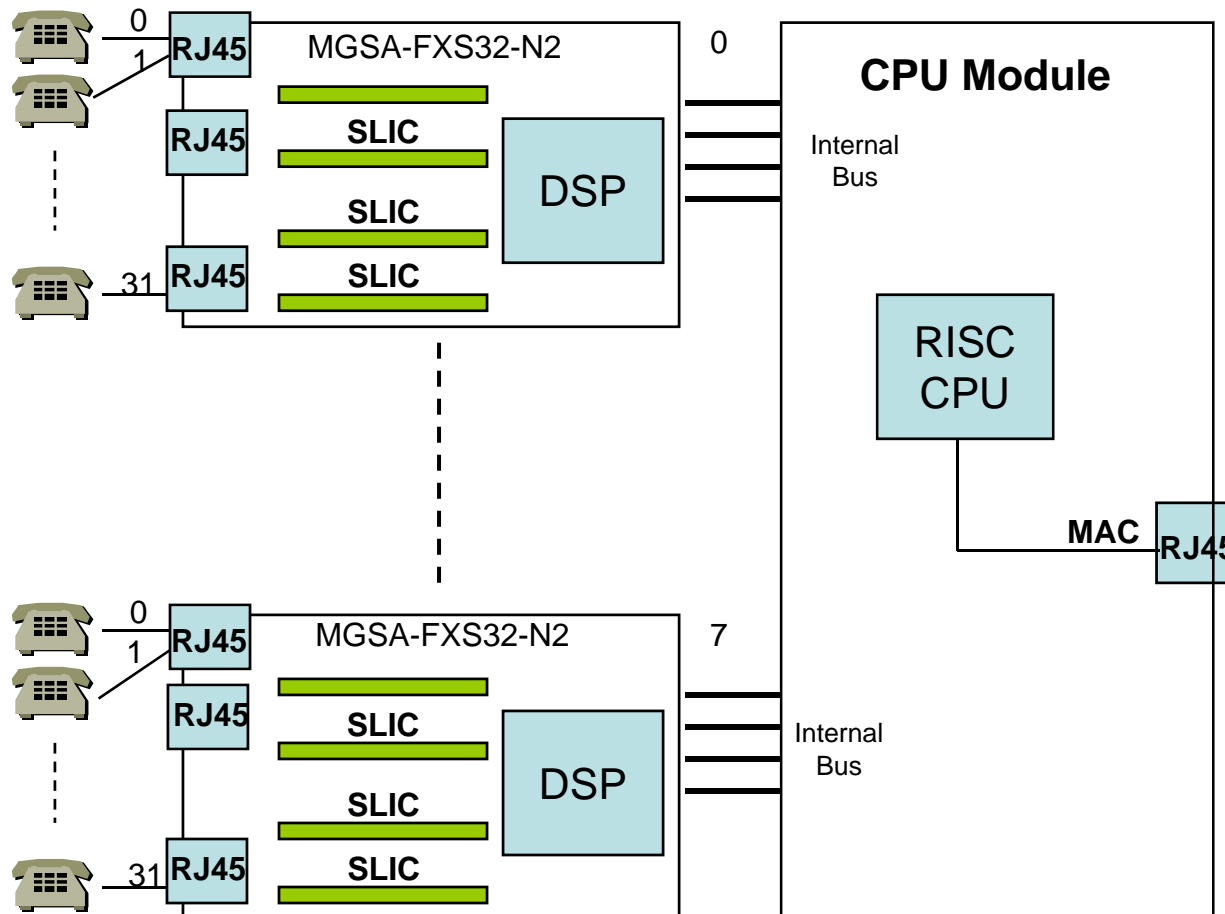

# Hardware Specification

IPNext350 Hybrid IP-PBX System

RISC  
CPU

High-end  
DSP

## IPNext320 VoIP Module Combination Diagram

224-Port(32x7Module) FXS + 32-Port (32x1Module) FXO Gateway Service Diagram

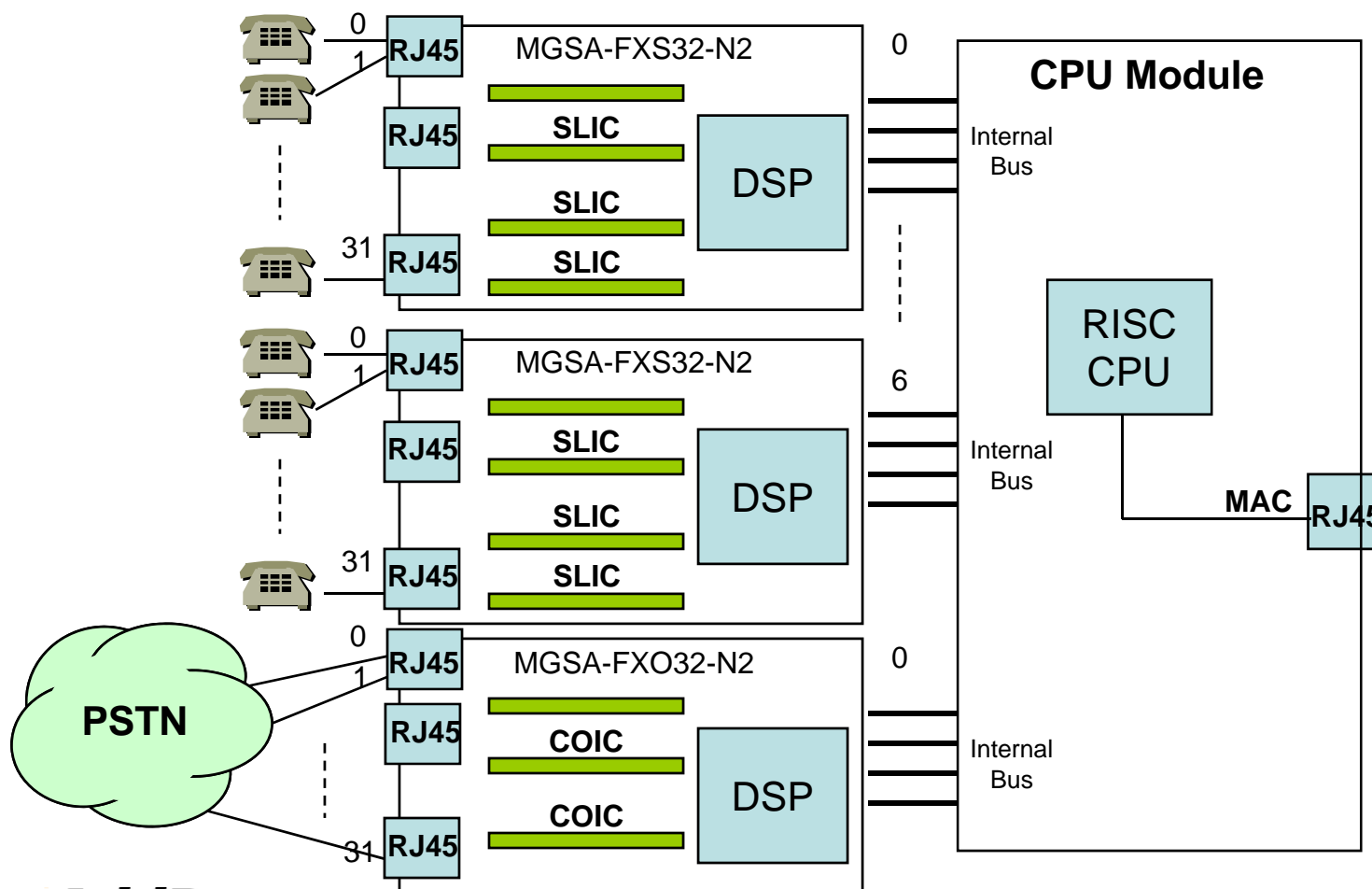

**AddPac**

www.addpac.com

# Software Service

IPNext350 Hybrid IP-PBX System

- Built-in AddPac APOS Internetworking Software
  - Scalability, Functionality, and Stability Features
  - Advanced Call Manager Features
  - Media Gateway Features
  - QoS Control Features
- Programmable Video, Audio, and Voice Services
  - Audio, and Voice Codec
- Firmware Upgradeable Architecture
- Industry Standard Network Protocol Features
- Highly User Friendly Management Features
  - Smart Messenger for UC
  - Smart Multimedia Manager

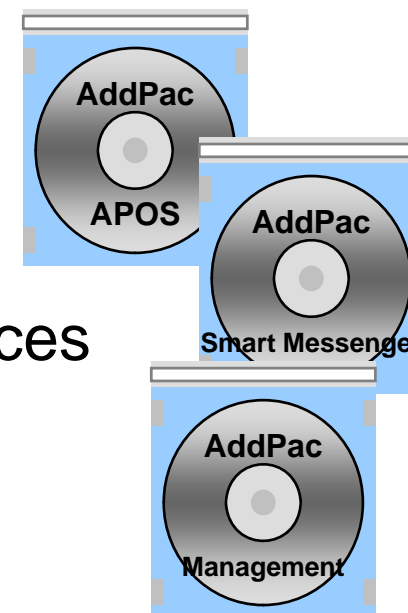

# IP-PBX Software Components

IPNext350 Hybrid IP-PBX System

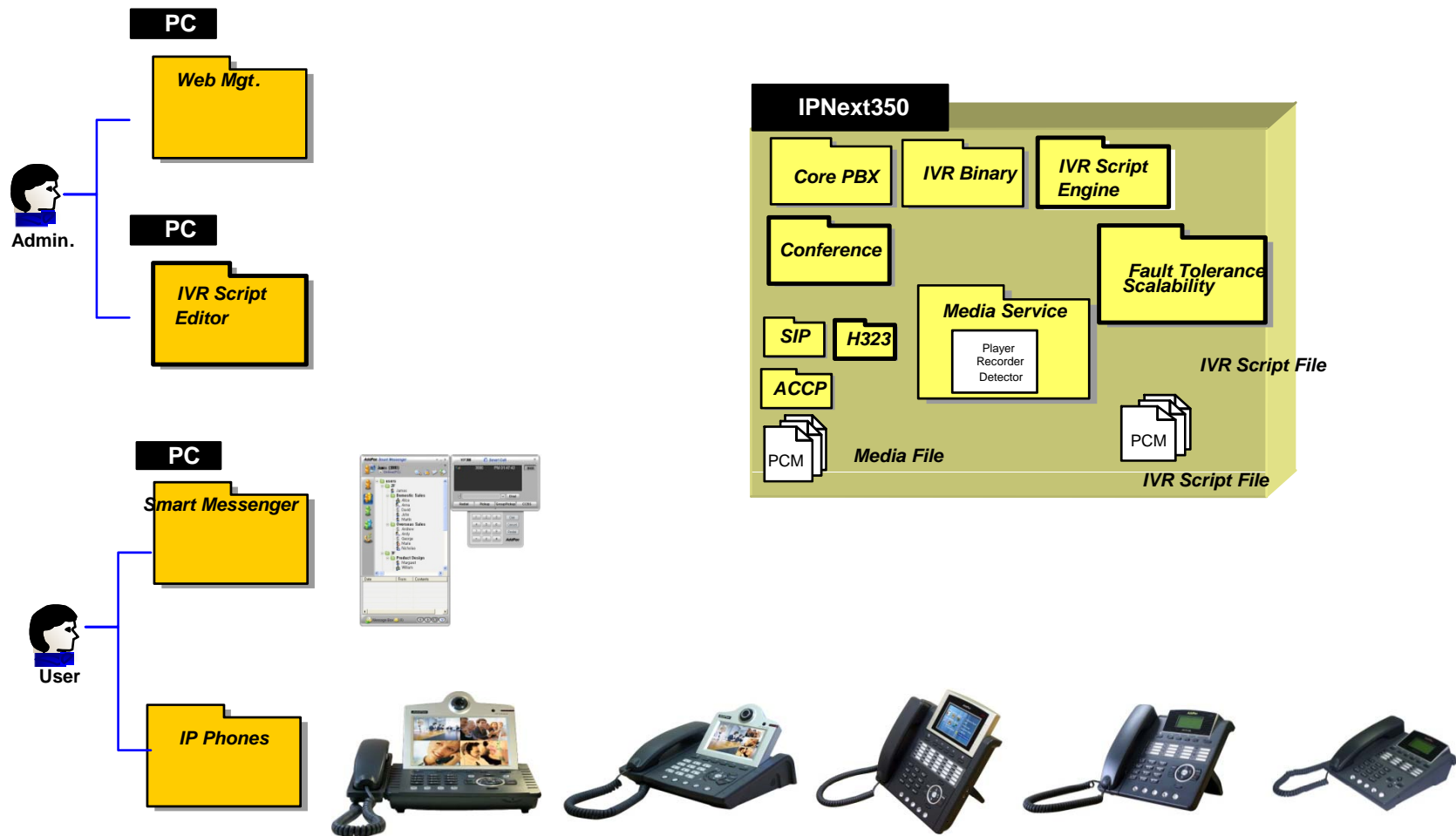

# IP Telephony Service and Features

## IPNext350 Hybrid IP-PBX System

- **Signaling Server**

- SIP Application Server, Proxy, Registrar and Location Server (RFC3261)
- Multiple ITSP Trunk with SIP & H.323 Accounts Support
  - IP UA Client Role for Registering to ITSP SIP Server
  - H.323 Gatekeeper Client Role for Registering to ITSP H.323 Gatekeeper Server

- **IVR & Auto Attendant**

- Default Auto Attendant Support
- Interactive Voice Response (IVR)
  - Provides with GUI-based Smart IVR Scenario Editor
  - Upload/Download Scenario by Smart IVR Scenario Editor
  - Supports Multiple Concurrent Scenarios
  - Supports Recordable IVR Prompts

- **Voice Mail**

- Support Voice Mail with IVR
- Access from Remote Site via Trunk Support
- Voice Mail Notification Support

# IP Telephony Service and Features

## IPNext350 Hybrid IP-PBX System

- **Number & Call Routing**

- Trunk Hunting by Preference or Sequential
- Call Hunting by Preference, Simultaneous, Random
- Call Hunting by Chained Hunting Group
- Partition for Address Grading
- Call Class for Call Access Control
- Number Translation Rule for Inbound/Outbound Call
- Centrex with Prefix Support
- Multiple Shared Devices with One Number
- Multiple Numbers on One Device
- Individual Call Park within Park Number Pool
- Group Call Park within a Group or Other Group
- Call Pickup of Ringing Call of Same Group or Other Group
- Call Pickup of Parked Call
- Call Transfer - Blind, Consult
- Call Forwarding - Unconditional, Busy, No Answer, Voice Mail
- Call Waiting
- Call Swaping
- Call Hold



# IP Telephony Service and Features

## IPNext350 Hybrid IP-PBX System

- **IP-PBX Advanced Features with AddPac IP Phones**

- Multiple Call Handling with Call Status and Calling Line Number and Name
- Plug and Play with Auto Discovery Function
- Softkey Map Download and Control
- Time and Date Setting
- Voice Mail List View
- Parked Call List View
- Call Forward Setting
- Recent Call List View
- Calling Number and Name Identification
- Individual Call Park within Park Number Pool by Softkey
- Group Call Park within a Group or Other Group by Softkey
- Call Pickup of Ringing Call of Same Group or Other Group by Softkey
- Call Pickup of Parked Call by Softkey
- Call Transfer - Blind, Consult by Softkey
- Call Waiting Indication
- Call Swaping by Softkey
- Call Hold by SoftKey
- Conference Control

# IP Telephony Service and Features

## IPNext350 Hybrid IP-PBX System

- **User & Device Management**

- LDAP (Light weight Directory Access Protocol) Support
  - Supports Hierarchical Organization
- Auto Discovery of IP Phones & Video Phones
- Monitoring Status of Phones

- **Miscellaneous\***

- Distinctive Ring by Calling User
- Auto Config & Upgrade
- Personal Directory
- Downloadable Ring
- Do not Disturb

# IP Telephony Service and Features

## IPNext350 Hybrid IP-PBX System

- **Conference**

- G.711 (4-party Conference, 2 session) : basic
- Ad-hoc Conference
- Dial-Out Conference
- Meet-me Conference
- Multiple External MCU support( Video, Audio, etc) : AddPac AP-MC1000, etc
- Conference Chair and Participants Management

- **Music & Announcement**

- Music on Hold
- Replaceable Announcements
- Dialing Music / Tone Service

# SIP based Basic Call Scenario

IPNext350 Hybrid IP-PBX System

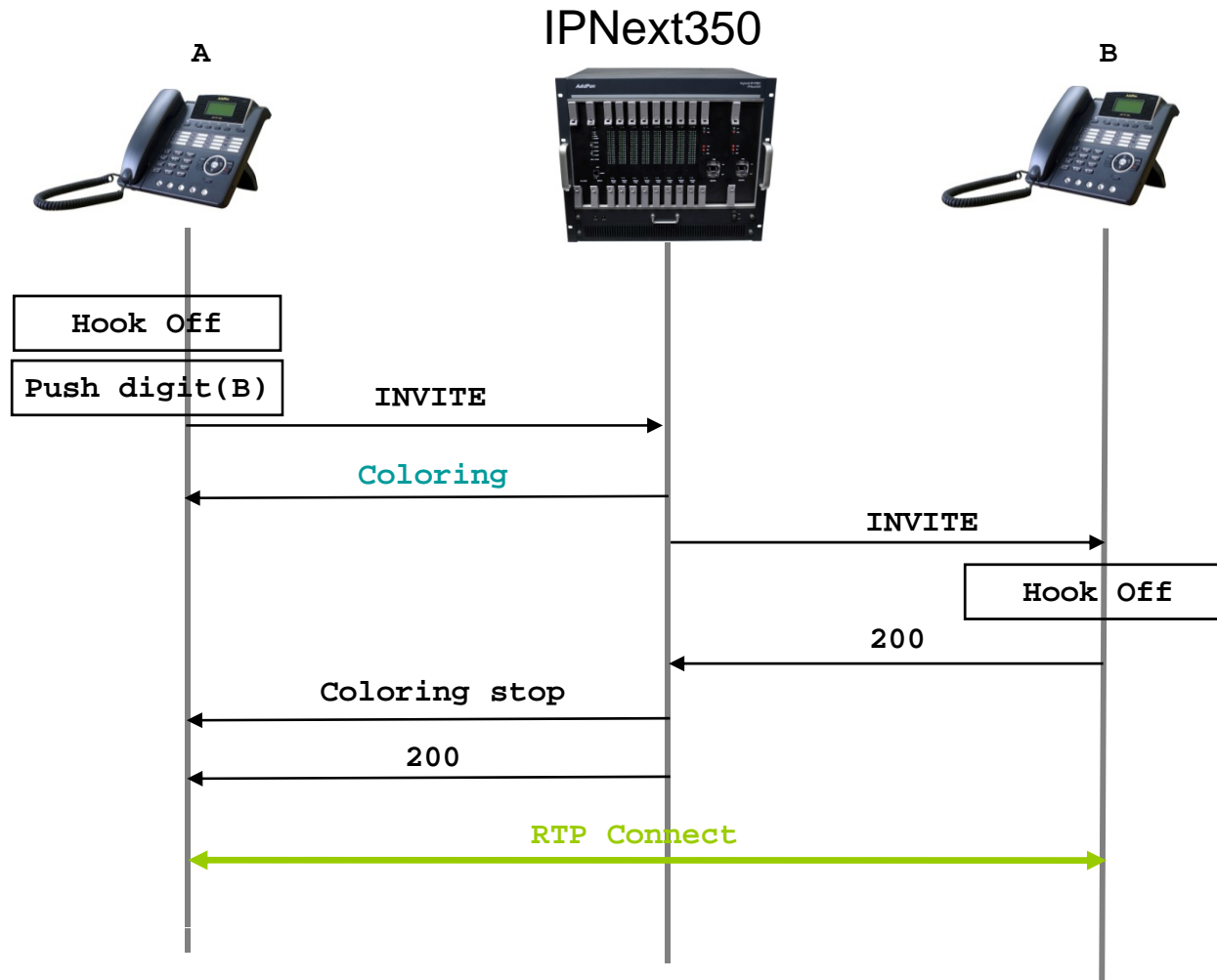

# RTP Proxy Service

IPNext350 Hybrid IP-PBX System

Public/Private RTP Proxy  
without NAT Router

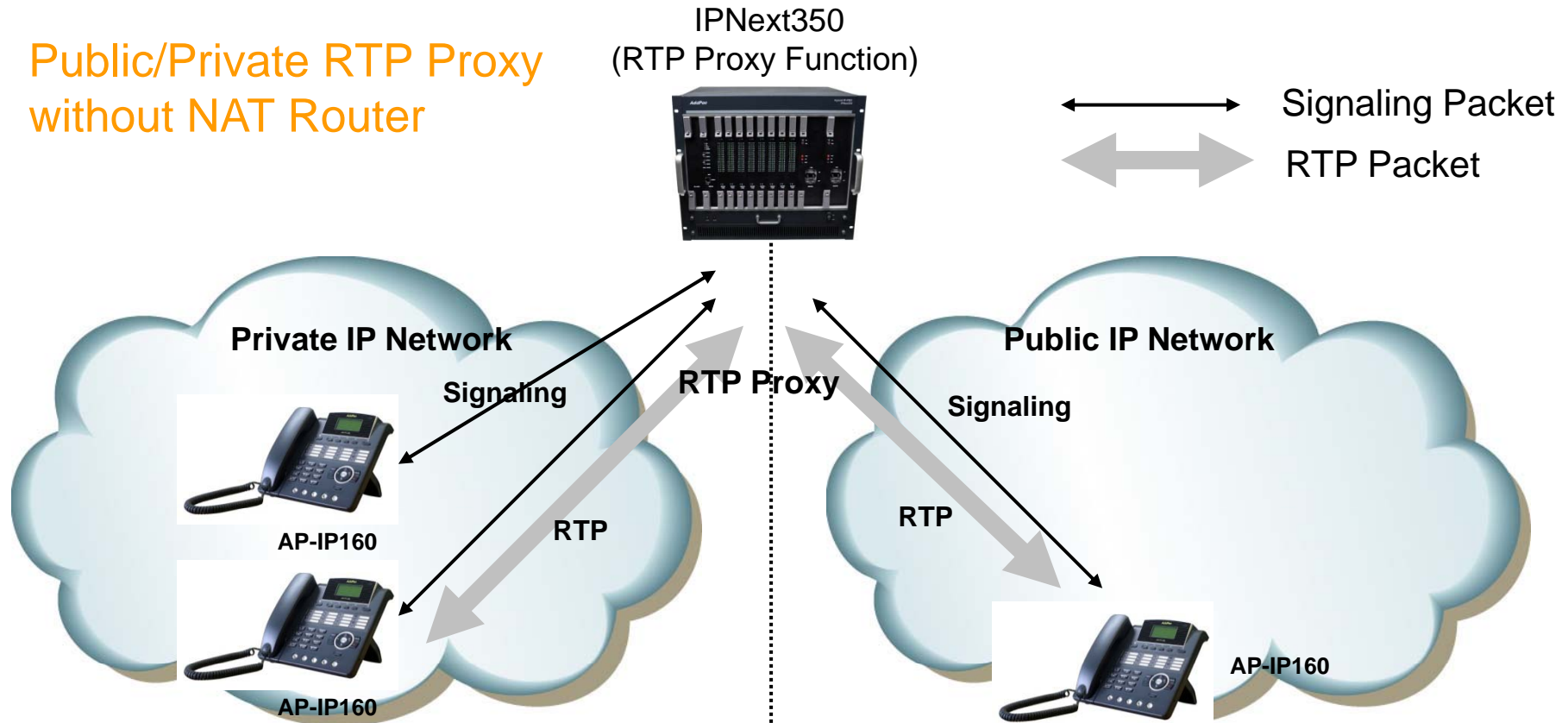

- Located between public and private network
- IPNext350(Call manager + RTP proxy) has public and private address
- IPNext350 determine that the call is internal or external

# RTP Proxy Service

IPNext350 Hybrid IP-PBX System

## Asymmetric/Symmetric NAT

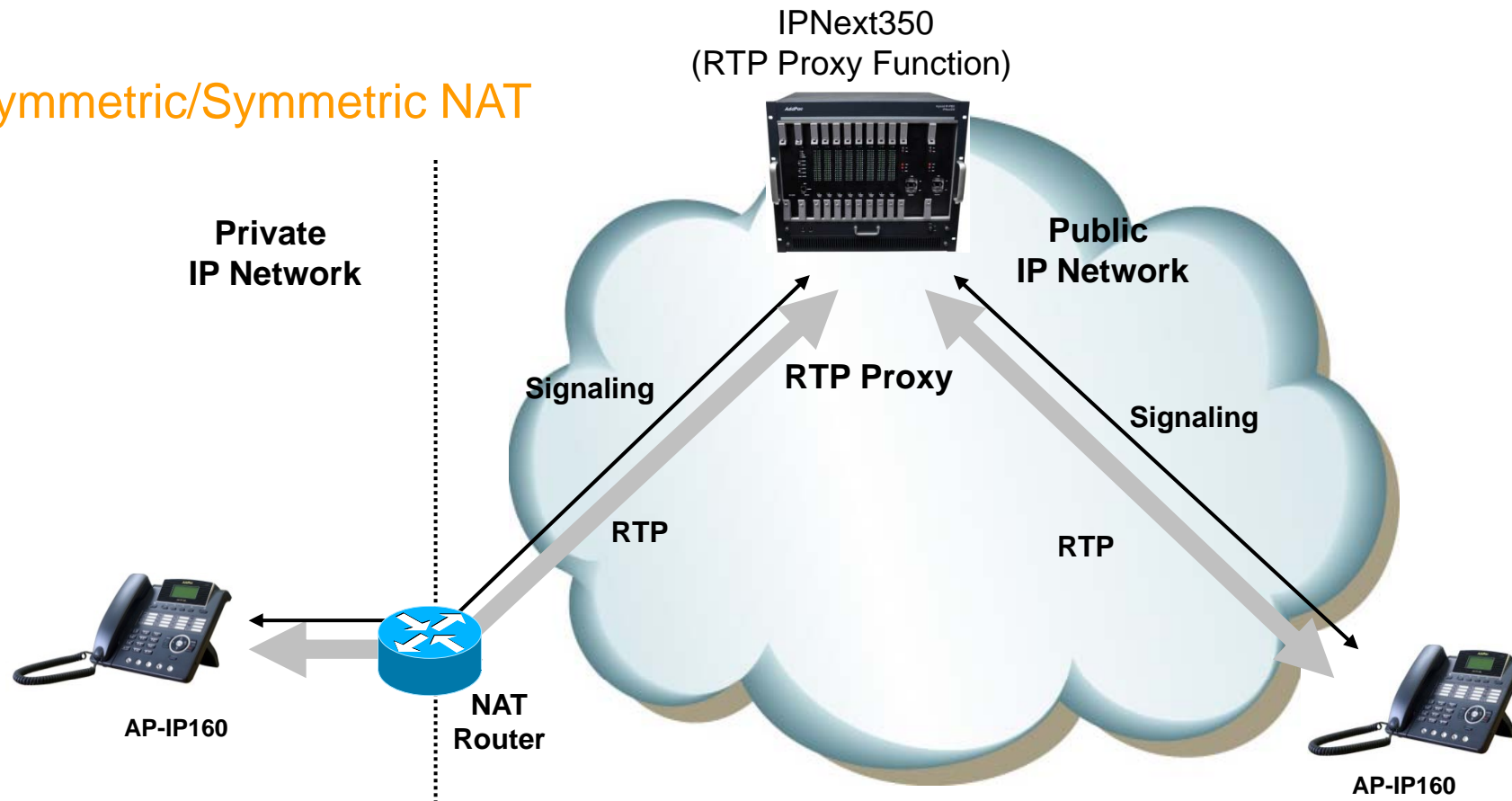

- Located in public network
- RTP Proxy has single public address
- Auto detect for asymmetric NAT via incoming RTP packet

[www.addpac.com](http://www.addpac.com)

# RTP Proxy Service

IPNext350 Hybrid IP-PBX System

## RTP Proxy Communication between Private IP

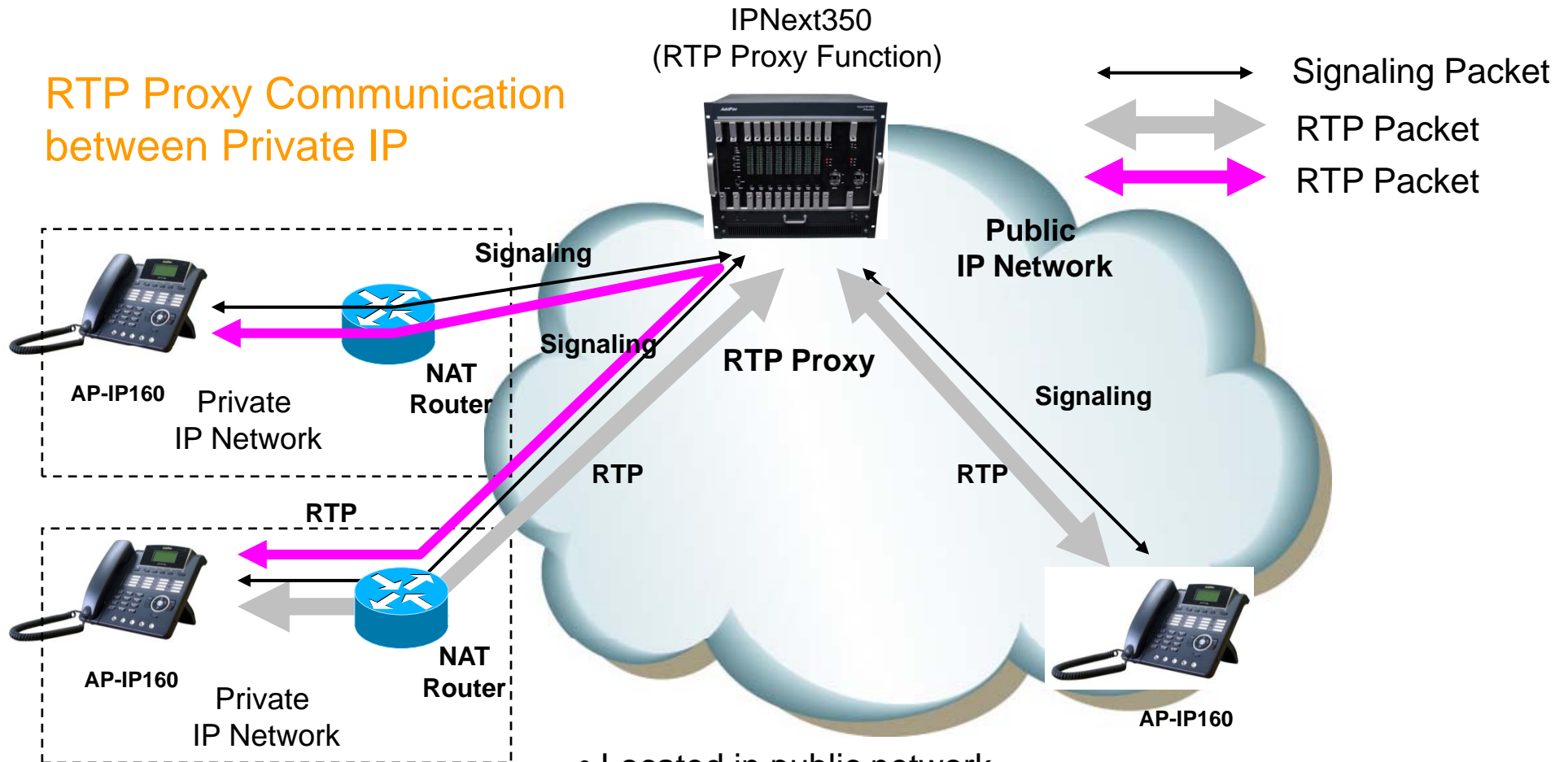

- Located in public network
- RTP Proxy has single public address
- Auto detect for asymmetric NAT via incoming RTP packet

# RTP Proxy Service

IPNext350 Hybrid IP-PBX System

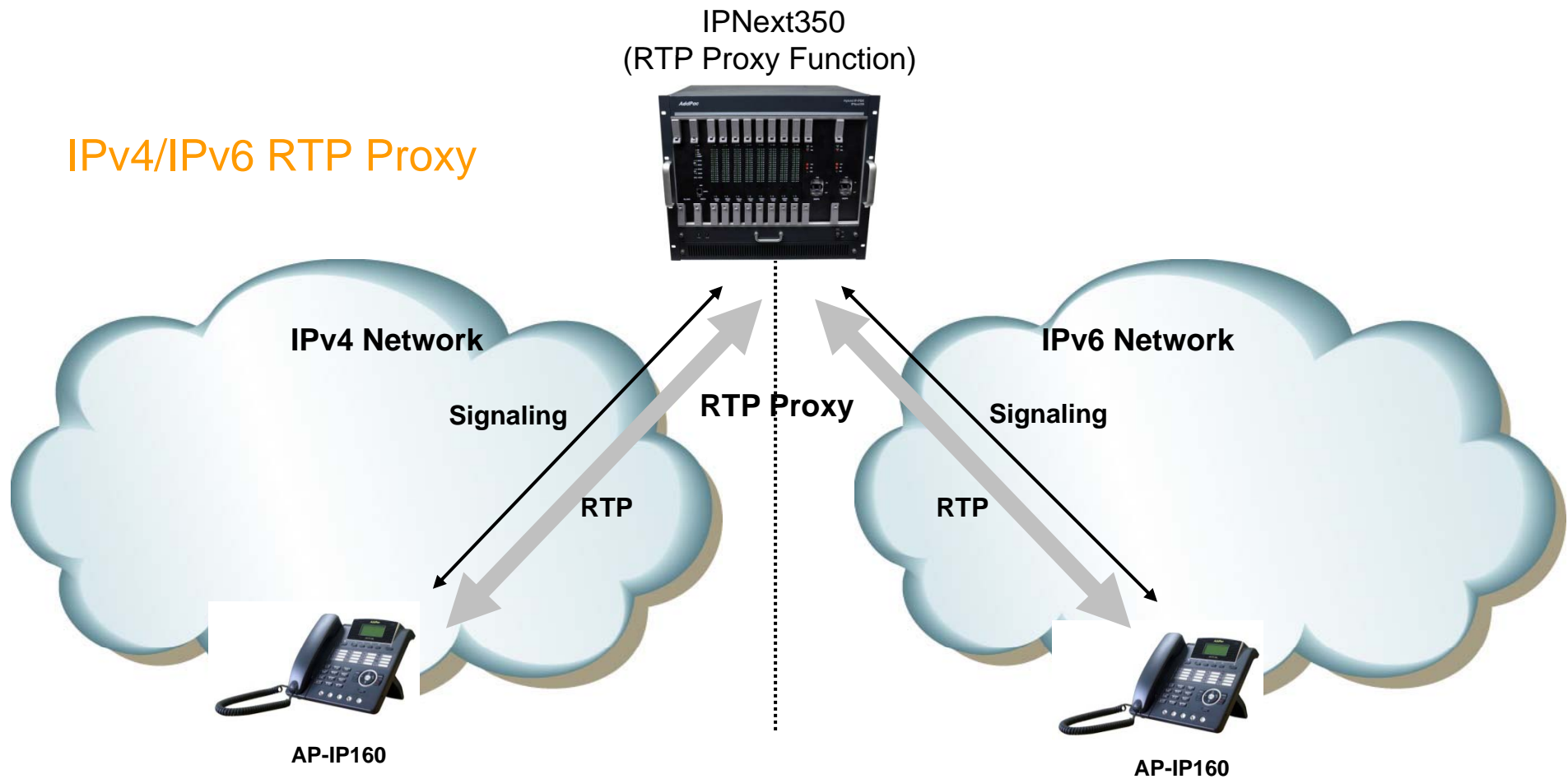

- IPNext350(Call manager + RTP proxy) has IPv4 and IPv6 address



# User Presence Service for UC

## IPNext350 Hybrid IP-PBX System

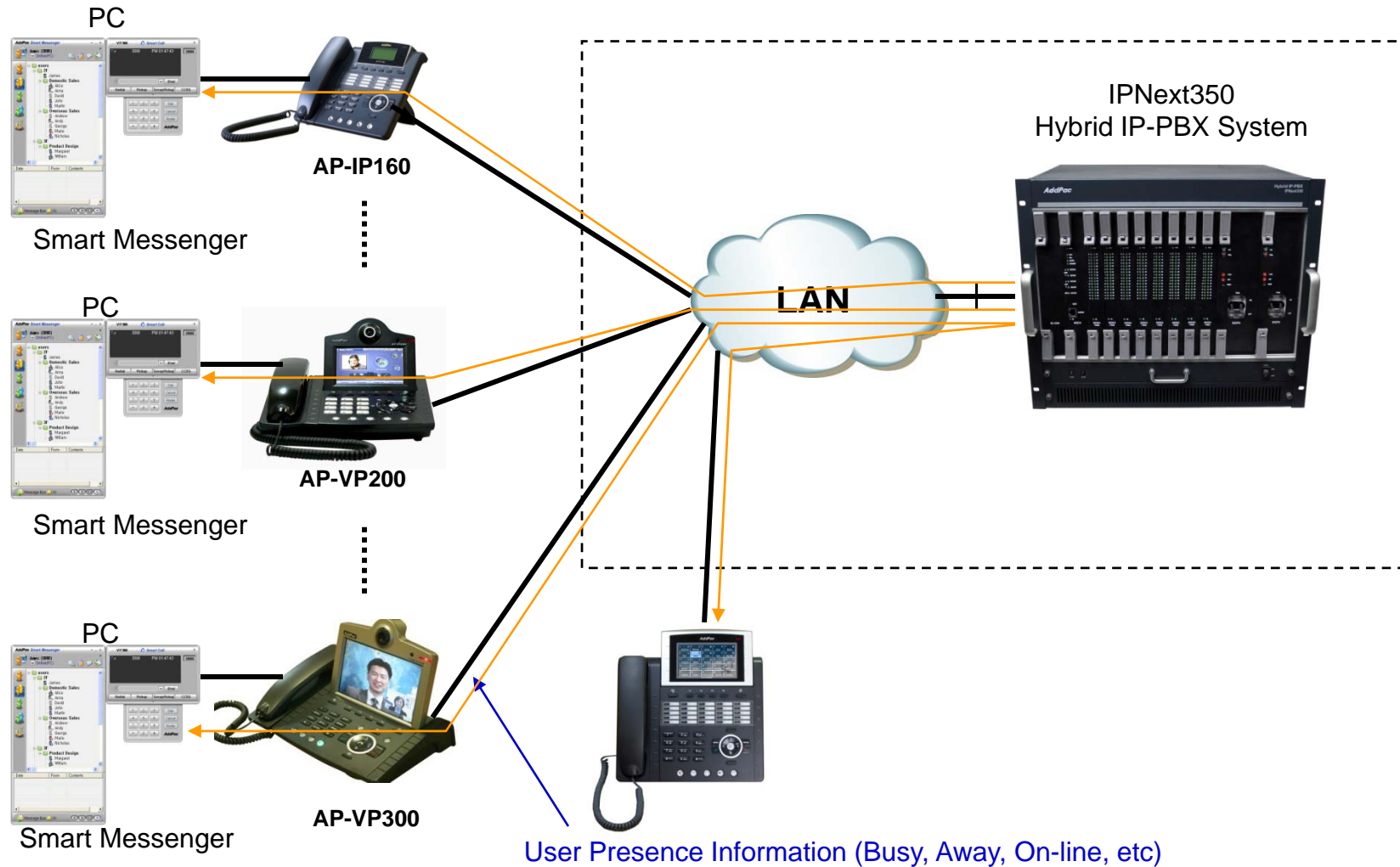

# Network Service and Features

## IPNext350 Hybrid IP-PBX System

- **Basic Network Protocols**
  - ARP, IP, IPv6, TCP, UDP, ICMP, ICMPv6, SCTP, IGMP, MLD
- **Routing Protocol**
  - IPv4 : Static
  - IPv6 : Static
- **Service Protocol**
  - FTP, Telnet, TFTP, DHCP Server/Relay, SNMP Server
  - CDP (Cisco Discovery Protocol)
  - DNS Resolver , DDNS(nsupdate)
  - Bridge
  - Syslog
  - IP/IPv6 policy control (QoS)
  - VPDN (Virtual Private Dial-up Network : L2TP Server)

# Network Service and Features

## IPNext350 Hybrid IP-PBX System

- IPv4/IPv6 Interworking
  - NAT/PAT for IPv4
  - IP connect (formerly ip-share) and device cascade for IPv4
  - IP/IP, IP/GRE tunneling
  - NAT-PT
  - 6to4, Autoconfig tunneling
- IPv4 Address Configuration
  - Fixed (Static)
  - DHCP
  - PPPoE
- IPv6 Address Configuration
  - Fixed (Static)
  - EUI-64
  - Autoconfig (Neighbor Advertisement and Solicitation)

# Network Service and Features

IPNext350 Hybrid IP-PBX System

- **Miscellaneous**
  - Cisco Style CLI
  - Standard & Extended IPv4/IPv6 Access List
  - Multi-level User Account Management
  - IP accounting
  - fsh (Embedded file system shell)
  - STUN Client

# Network Service and Features

IPNext350 Hybrid IP-PBX System

- **SNMP MIBs**
  - MIB-II
  - RMON MIBs (Statistics, History, Alarm, Hosts Group)
  - RFC2465 Management Information Base for IP Version 6: Textual Conventions and General Group
  - RFC2466 Management Information Base for IP Version 6: ICMPv6 Group
  - RFC2452 IP Version 6 Management Information Base for the Transmission Control Protocol
  - RFC2454 IP Version 6 Management Information Base for the User Datagram Protocol
  - AddPac Enterprise MIBs
  - etc

# IP Multimedia Terminals

IPNext350 Hybrid IP-PBX System

- AP-VP500 Video Phone
- AP-VP350 MCU Video Phone
- AP-VP300 Video Phone
- AP-VP280 Video Phone
- AP-VP250 Video Phone
- AP-VP150 Video Phone
- AP-VP120 Video Phone
- AP-IP300 Premium IP Phone
- AP-IP160 IP Phone
- AP-IP120 IP Phone
- AP-IP90 IP Phone
- AP-WP100 WiFi Phone
- AP-SMP100 Soft Phone
- AP-PT100 Presence Terminal
- AP-PT50 Presence Terminal
- AP-PT20 Presence Terminal



AP-VP500



AP-VP300



AP-VP150



AP-WP100



AP-VP120



AP-IP300











AP-IP160



AP-IP120





# AddPac IP Video Phone Comparison Table

## IPNext350 Hybrid IP-PBX System

	AP-VP500	AP-VP350	AP-VP300N	AP-VP280	AP-VP250	AP-VP230	AP-VP150	AP-VP120
								
LCD Size	12.1 Inch Touch Screen	7Inch Touch Screen	7Inch Touch Screen	7Inch Touch Screen	4.3Inch Touch Screen	5Inch Touch Screen	4.3Inch Touch Screen	4.3Inch
Camera	CCD	CCD	CCD	CMOS	CMOS	CMOS	CCD	CMOS
Video Codec	H.263 MPEG4 H.264	H.263 MPEG4 H.264	H.263 MPEG4 H.264	H.263 MPEG4 H.264	H.263 MPEG4 H.264	H.263 MPEG4 H.264	H.263 MPEG4 H.264	H.263 MPEG4 H.264
Signaling	H.323/SIP	H.323/SIP	H.323/SIP	H.323/SIP	H.323/SIP	H.323/SIP	H.323/SIP	H.323/SIP
Video MCU	N/A	4-Party Video MCU	N/A	N/A	N/A	N/A	N/A	N/A
Voice MCU	3-Party	3-Party	3-Party	3-Party	3-Party	3-Party	3-Party	3-Party
LAN Port	2	2	2	2	2	2	2	2
PoE	N/A	N/A	Support	N/A	Support	Support	Support	Support

# AddPac IP Phone Comparison Table

## IPNext350 Hybrid IP-PBX System

	AP-IP300	AP-IP250	AP-IP230	AP-IP160	AP-IP120	AP-IP90
						
LCD Size	4.3 Inch Color LCD	4.3 Inch Color LCD	5 Inch Color LCD	4 Text Line Graphic LCD	4 Text Line Graphic LCD	4 Text Line Graphic LCD
Touch Screen	N/A	Support	Support	N/A	N/A	N/A
Speed-Dial Keys	25 Key with Presence LED	Touch Screen based 25 Keys	Touch Screen based 25 Keys	16 Key with Presence LED	12 Key with Presence LED	N/A
Voice Codec	G.711/G.726/ G.729/G.723	G.711/G.726/ G.729/G.723	G.711/G.726/ G.729/G.723	G.711/G.726/ G.729/G.723	G.711/G.726/ G.729/G.723	G.711/G.726/ G.729/G.723
Signaling	H.323/SIP	H.323/SIP	H.323/SIP	H.323/SIP	H.323/SIP	H.323/SIP
3-Party Conversation	Support	Support	Support	Support	Support	Support
LAN Port	2	2	2	2	2	2
PoE(Optional)	Support	Support	Support	Support	Support	Support
FXO(Optional)	Support	Support	Support	Support	Support	Support



# AP-PT100 Presence Terminal

IPNext350 Hybrid IP-PBX System

- User Presence and Touch Screen based Speed Dialing Terminal
- “7 Inch Color TFT LCD with Touch Screen
- Inter-working with IP Terminal, Presence Server, Call Manager
- Multiple Terminal Cascading Feature
- User Presence Group Feature
- Firmware Upgradeable Architecture
- PoE (Power over Ethernet) Function
- Internal Speaker



# AP-PT50 Presence Terminal

IPNext350 Hybrid IP-PBX System

- Speed Dialing Terminal with User Presence Indication LAMP
- Inter-working with IP Terminal, Presence Server, Call Manager
- Multiple Terminal Cascading Feature
- User Presence Group Feature
- Firmware Upgradeable Architecture
- 60 Speed Dial Key with User Presence LAMP
- Connector for Cascading
- Optional PoE (Power over Ethernet) Interface
- Two(2) 10/100Mbps Fast Ethernet Interface
- External Power Adaptor (5V, 2A)



**AddPac**

[www.addpac.com](http://www.addpac.com)

# Smart Messenger for UC

IPNext350 Hybrid IP-PBX System

- Smart Messenger Program
  - PC based MS-Window Program
  - Support Messenger Service
  - Support Various Address Book
  - Support User Presence Information (Busy, Away, On-line, etc)
  - Support User Search Feature
  - Interoperation with Address Book and Smart Phone
  - Support Smart Phone Control and Setup
    - Call Control and Forward Setup
  - Support Unified Message Box
    - Voice Mail Box
    - Short Message Box



Smart Messenger

# Standard IP-PBX Application

IPNext350 Hybrid IP-PBX System

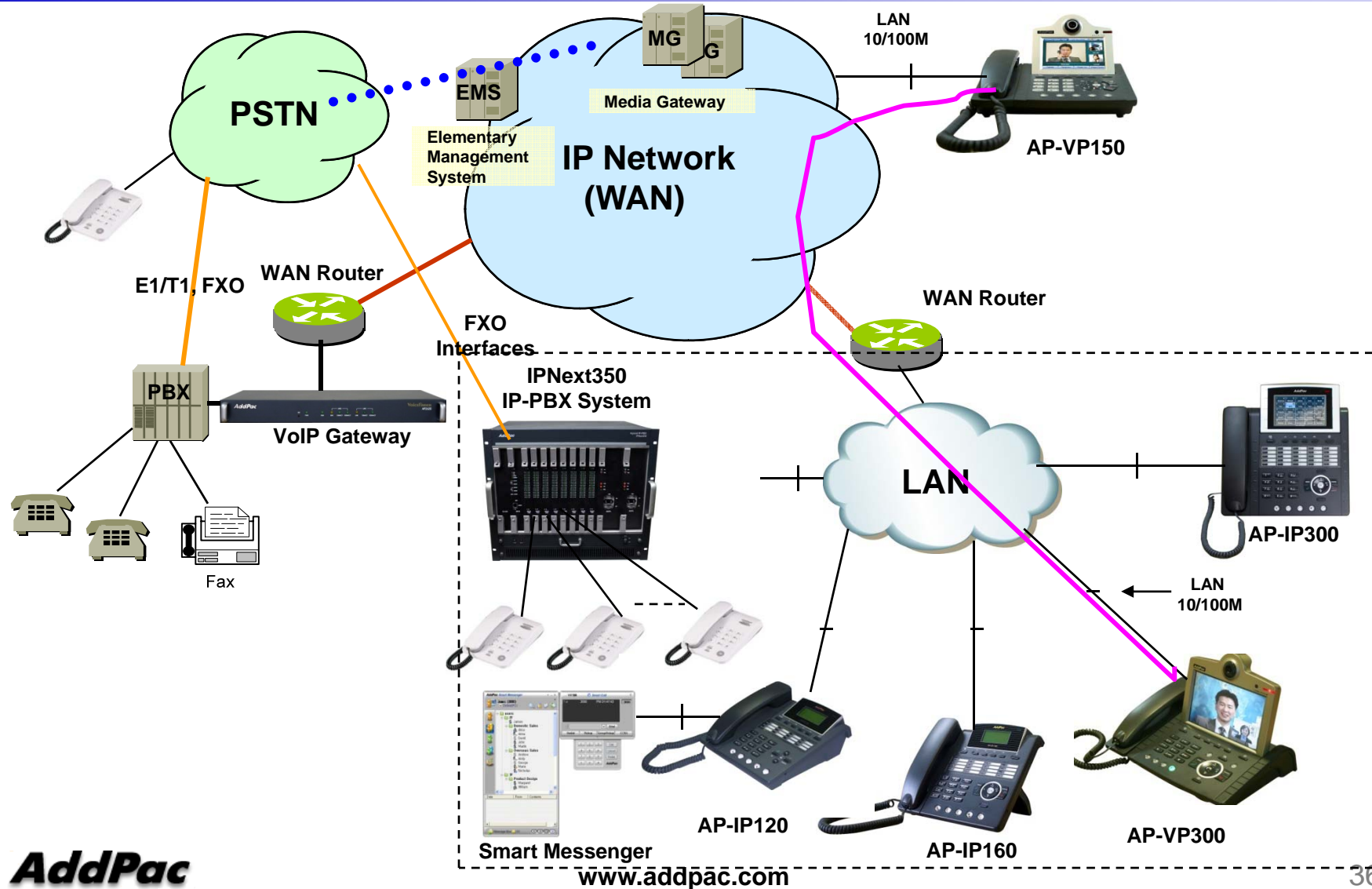

**AddPac**

[www.addpac.com](http://www.addpac.com)

# Ordering Information

- **IPNext350 Next Generation Hybrid IP-PBX System**
  - IPNext350 IP-PBX System Main Body
  - High-performance RISC CPU
  - Eight(8) VoIP Interface Module Slots
  - 2-port 10/100/1000Mbps Gigabit Ethernet and 1-port RS-232C Console
  - Module Type Dual Power Supply for Redundancy
  - Including Network Cable Set & Power Supply Cable, etc.
  - VoIP Interface Modules (Option)
    - : MGSA-FXS32, MGSA-FXS32-N1, MGSA-FXS32-N2, MGSA-FXO32, etc
- **Built-in APOS Internetworking Software for IPNext320**
- **Including 1 Year Hardware Warranty**
- **Product Documents**
  - Install and Operation Guide (PDF)
- **Pricing**
  - AddPac Technology Regional Sales Manager
  - Authorized Sales and Marketing Representatives
  - Please Contact [www.addpac.com](http://www.addpac.com)



# Thank you!

**AddPac Technology Co., Ltd.**  
Sales and Marketing

Phone +82.2.568.3848 (KOREA)

FAX +82.2.568.3847 (KOREA)

E-mail [sales@addpac.com](mailto:sales@addpac.com)