

VoIP



July 2003

Technical Sales and Marketing

AddPac Technology

www.addpac.com

AddPac VoIP Products Road-Map

Multi-services Specific

Application Specific

1/2/4/8/16~60-Ports Voice



AP3100 VoIP Gateway



AP2120 VoIP Gateway



AP100x/1100 VoIP G/W Series



AP300 VoIP G/W Series



AP200 VoIP G/W Series



AP160 VoIP Gateway

Voice over IP Solutions

4/8/16, 30~120-Ports Voice



AP2850 Multi-service Router



AP2830 Multi-service Router



AP2520S Secure VoIP Gateway



AP2520R VoIP Router



AP2520G VoIP Gateway



AP2110 VoIP Gateway

VoIP Network Management SW



AP-VPMS S/W Solution

Voice & FAX Broadcasting System



AP3120 Voice Broadcasting System



AP3220 FAX Broadcasting System



AP1601 Voice Broadcasting Terminal

General Purpose VoIP Networking

VoIP & Data Networking

IP Application Solutions

AddPac

www.addpac.com

July, 2003, AP200 VoIP products Presentation R1.00

AddPac AP160/200/300 Products Road-Map

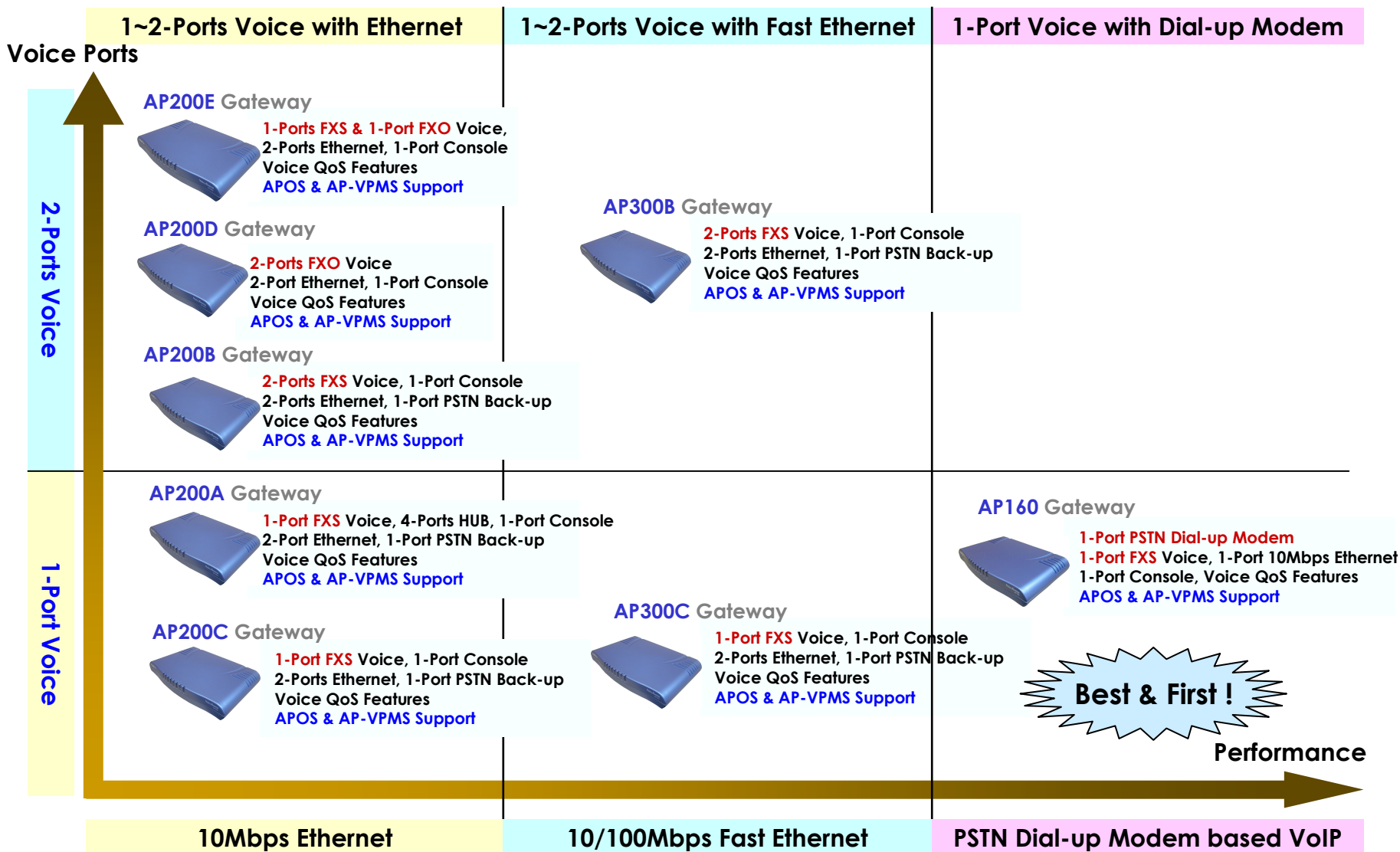

AddPac AP160 Dial-Up Products Road-Map

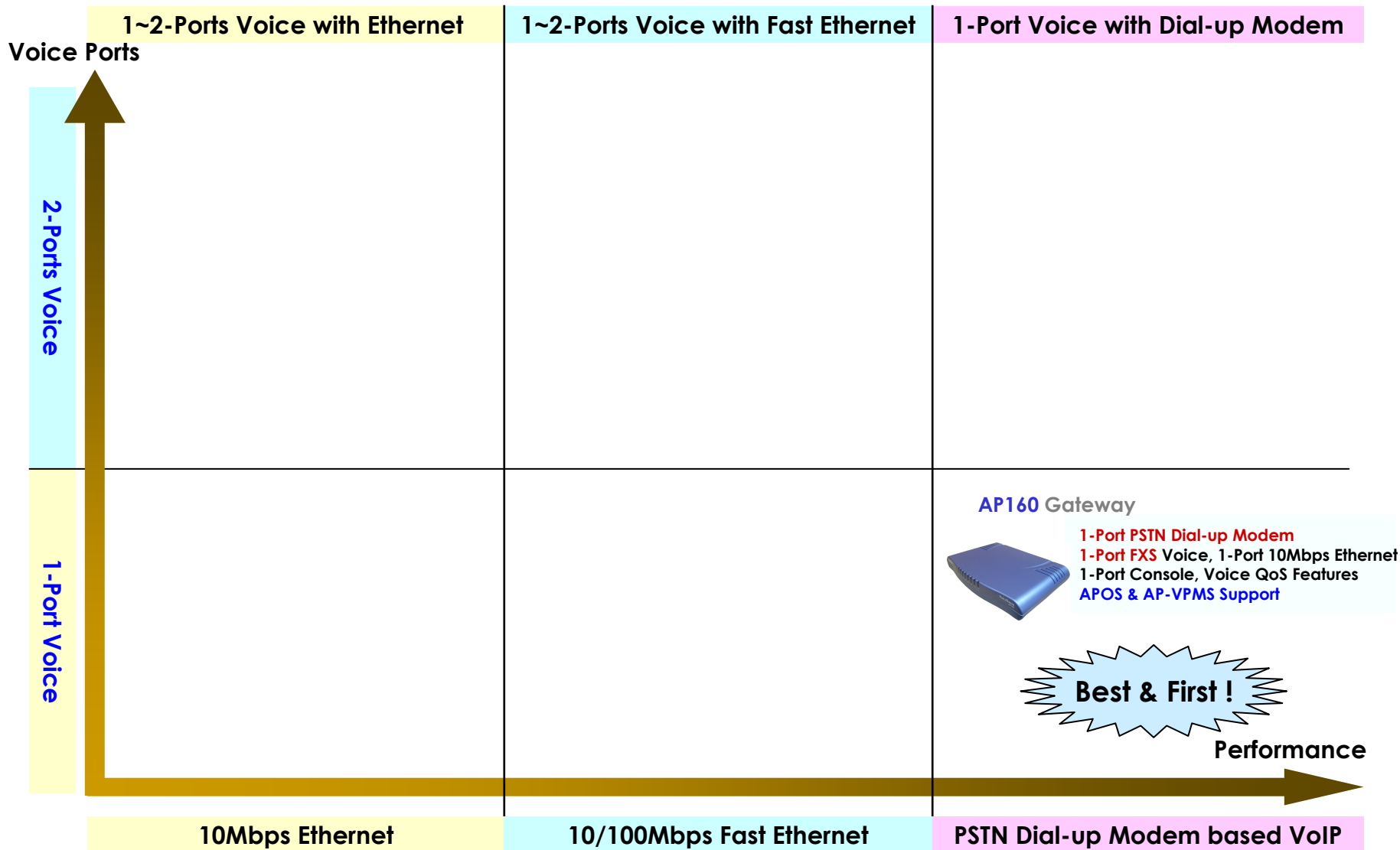

AP160 Dial-Up VoIP Gateway Product Overview

APOS Internetworking Protocol Stack

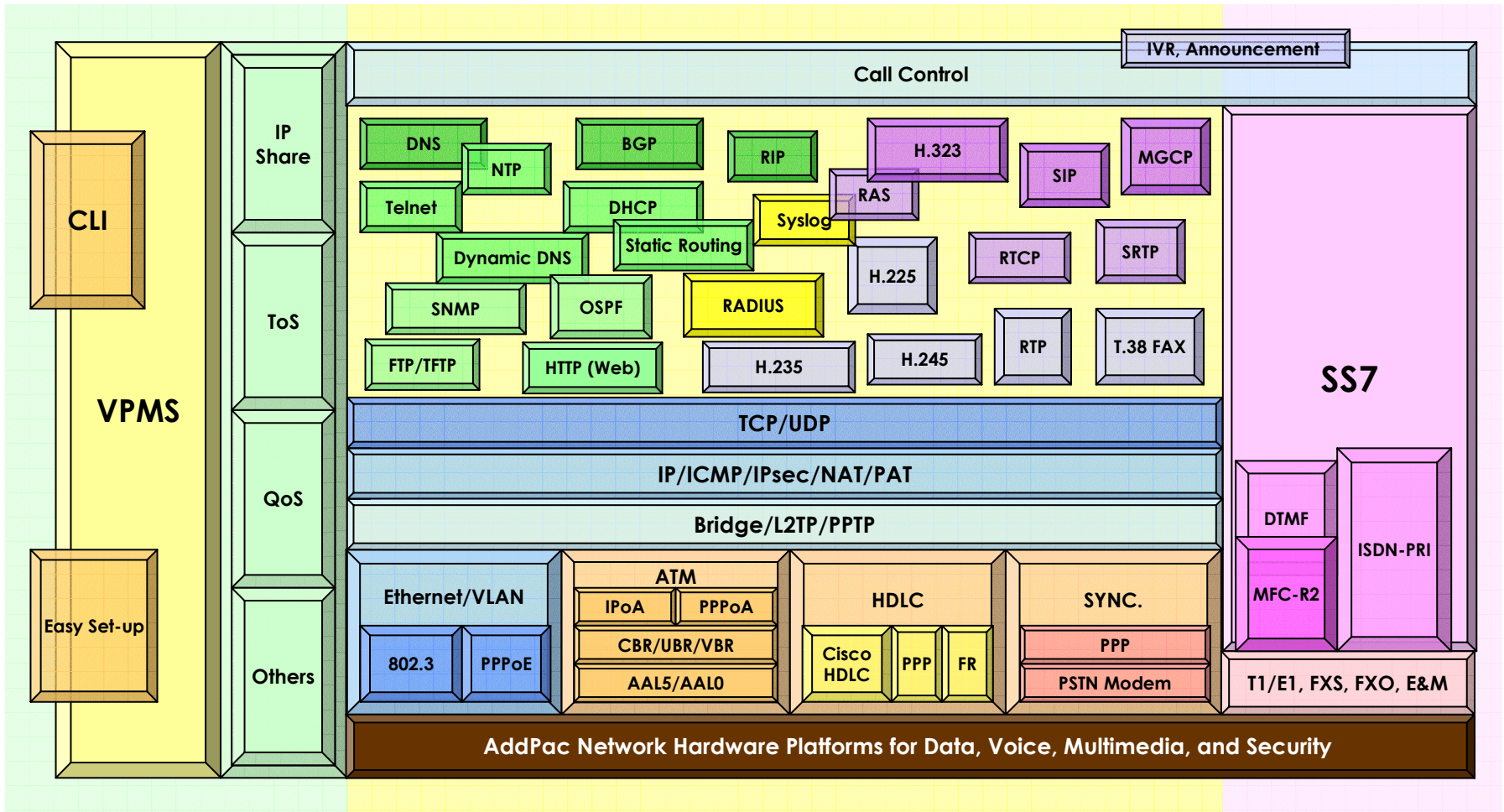

AP160 Dial-Up VoIP Gateway Product Overview

APOS Internetworking S/W World

• APOS Internetworking Software World

- AddPac Operating System (APOS)
- Support Industry Standard
- Integrated Networking Protocols
- Optimized Performance & Functionality
- Easy to use, Installation, and Maintenance

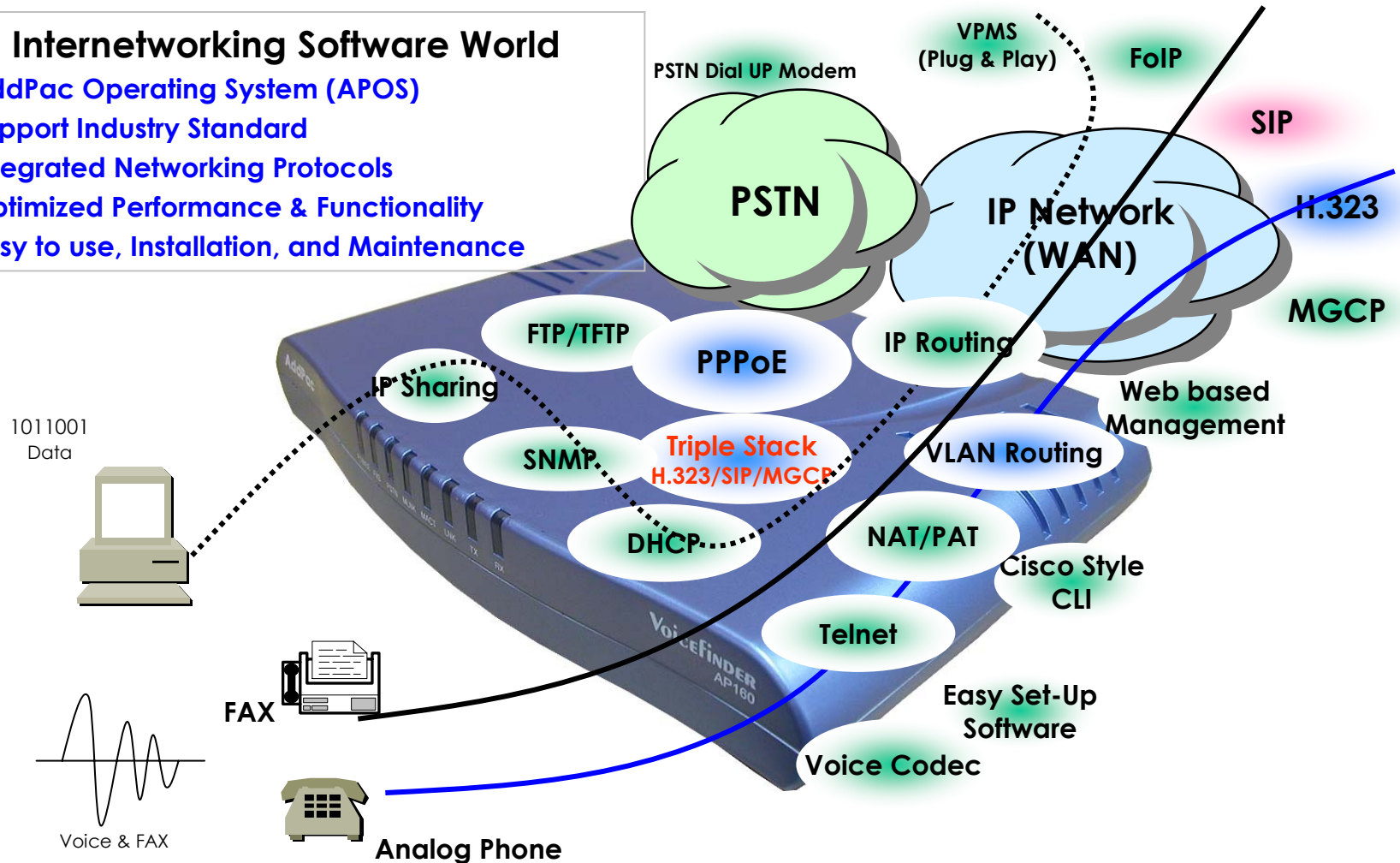

AP160 Dial-Up VoIP Gateway Product Overview

APOS Internetworking S/W World (cont.)

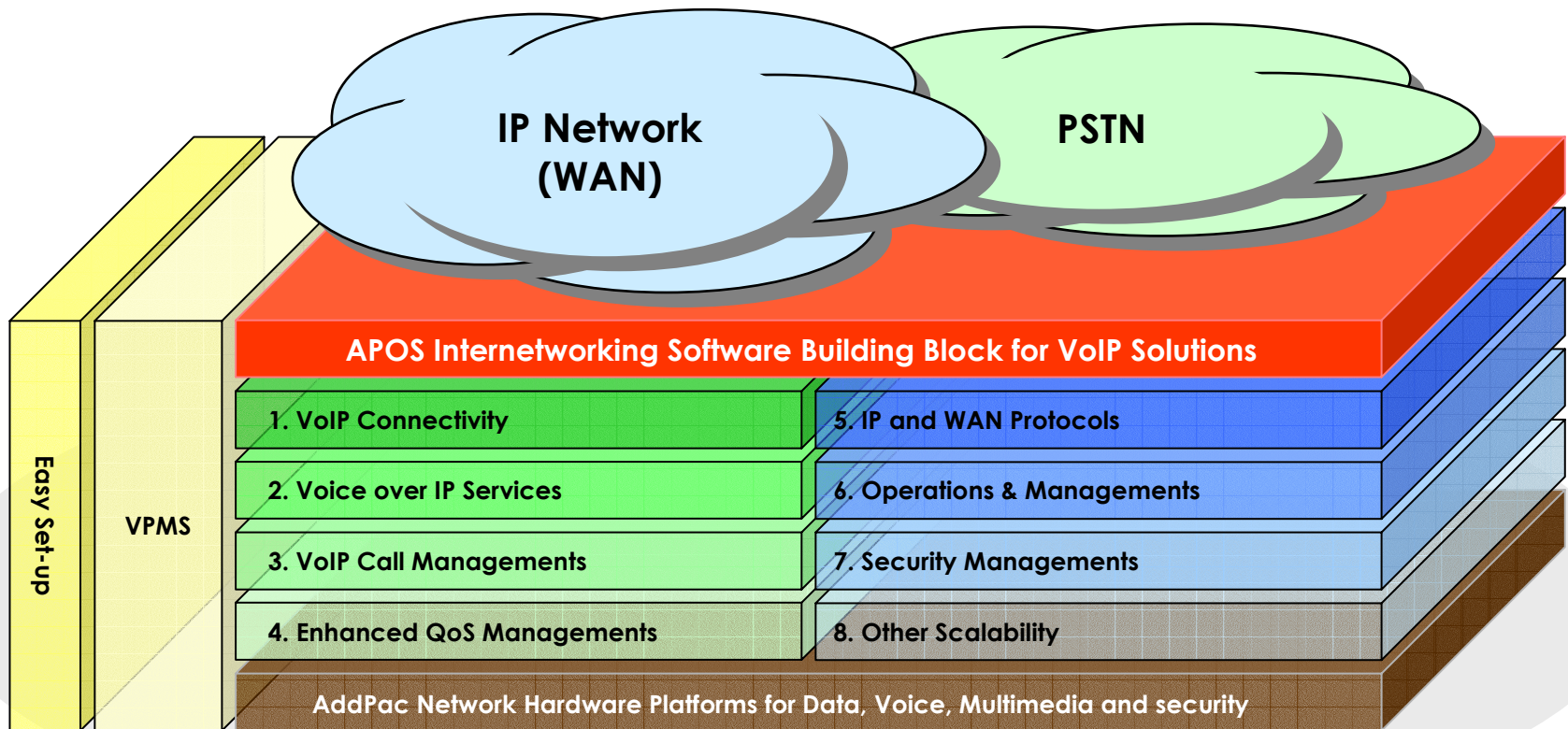

AP160 Dial-Up VoIP Gateway Product Overview

VoIP Gateway Connectivity

• FXS

- RJ-11 Hardware interface
- Polarity inverse generation function
- Caller-id generation function
- Busy-out function support
- Ring cadence setting function
- Ring frequency setting function
- European type II telephone support
- Surge protect support

• Dial-Up Modem

- QuickConnect and Modem-on-Hold™ functions (V.90+ models)
- V.34 (V.90+ and V.34 models), V.32bis, V.32, V.22 bis, V.22, V.23, and V.21; Bell 212A and Bell 103
- V.250 and V.251 commands
- V.44 data compression
- V.42 bis and MNP 5 data compression
- V.42 LAPM and MNP 2-4 error correction

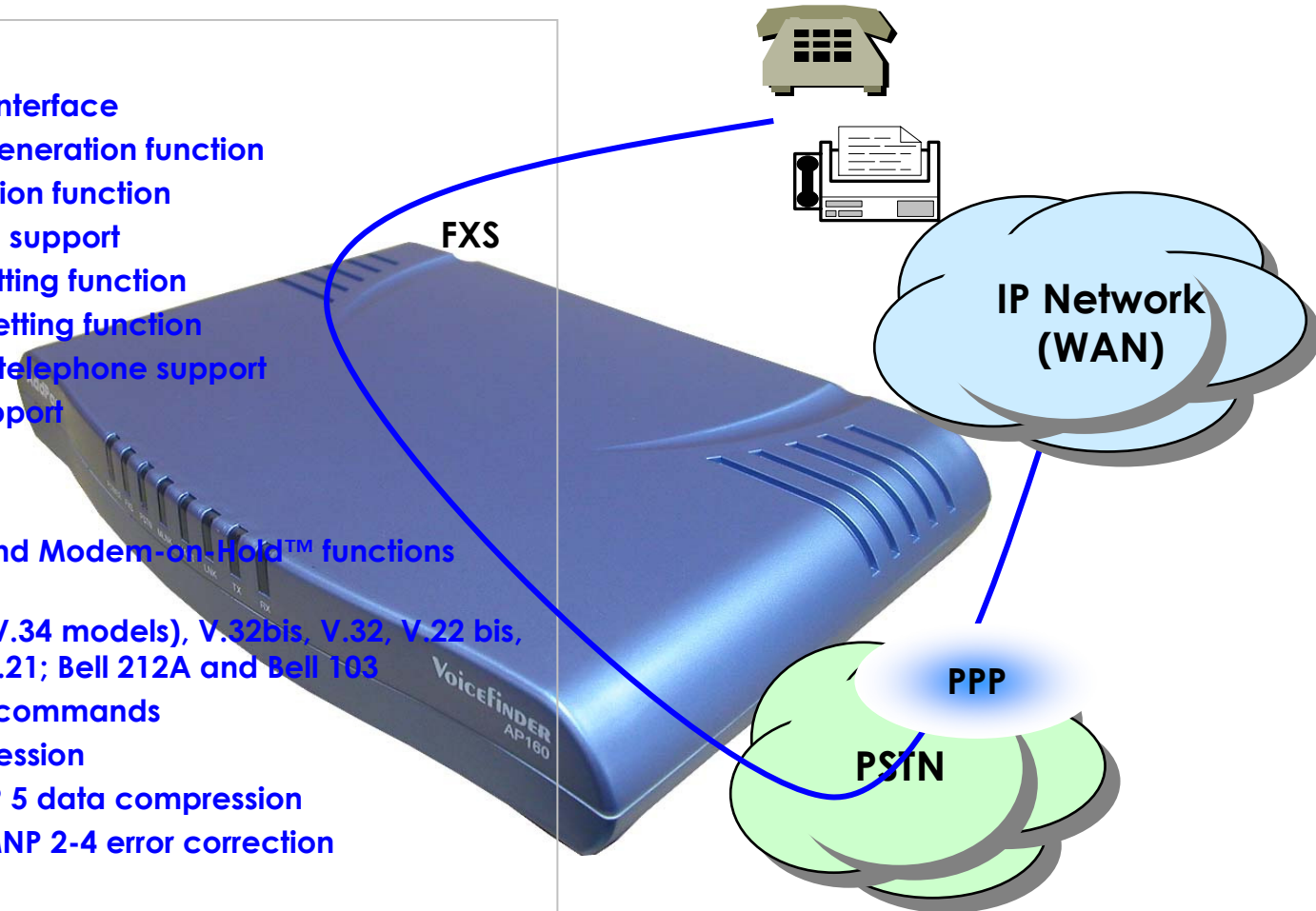

AP160 Dial-Up VoIP Gateway Product Overview

Voice over IP Service

- **H.323, SIP, and MGCP Triple Stack**
 - Concurrent Triple VoIP Stack Software
 - Single Hardware with Three VoIP Service
 - New APOS-NX Version
- **H.323**
 - ITU-T Standard H.323 v3 Support
 - Support H.245 Tunneling
 - Including H.235 Security Features
- **SIP**
 - IETF RFC3261 or RFC2543 SIP Standard
- **MGCP**
 - IETF RFC2705bis-02 Standard MGCP 1.0

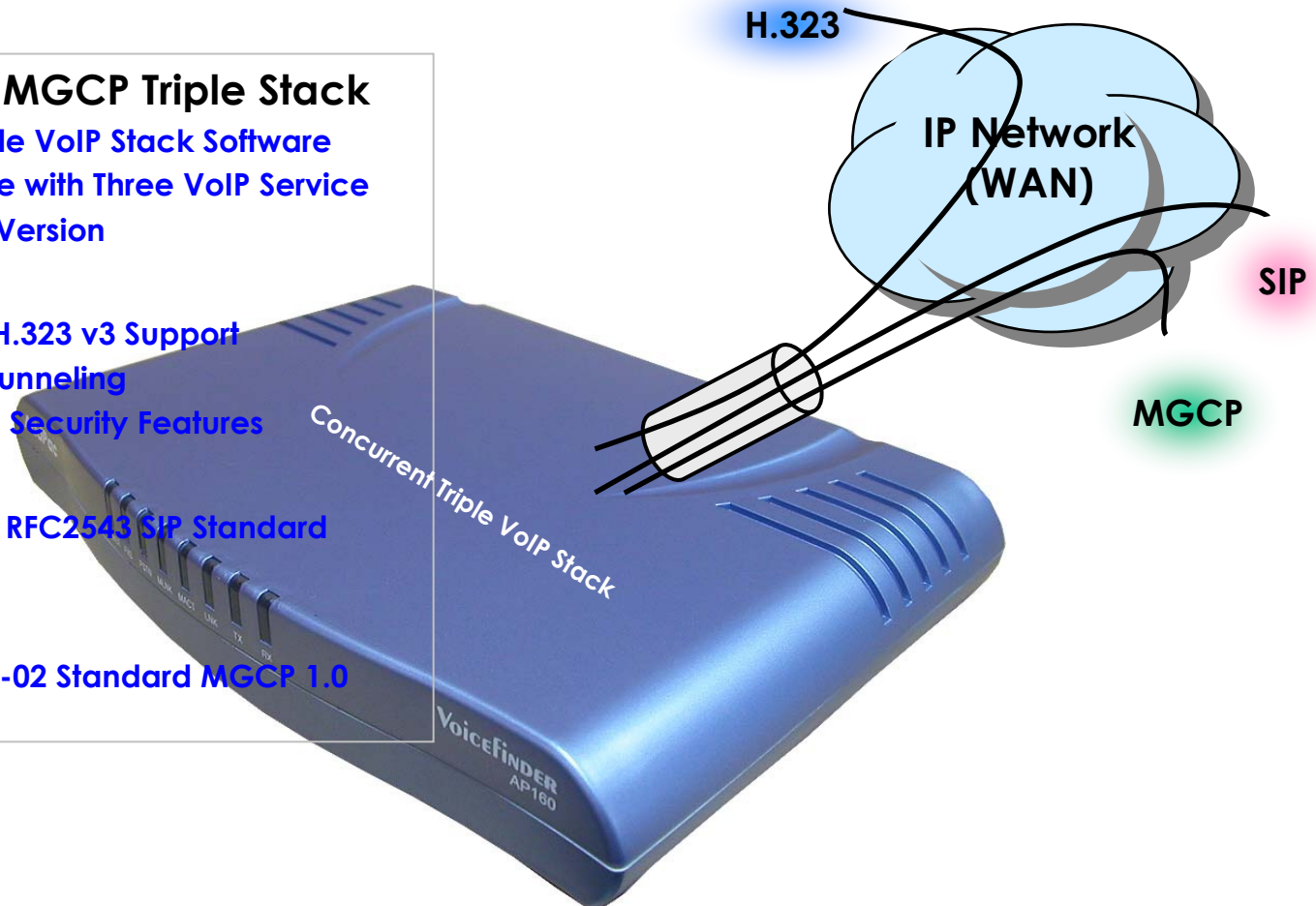

AP160 Dial-Up VoIP Gateway Product Overview

Voice over IP Service (cont.)

• H.323

- Fast connect, normal connect support
- H.245 tunneling support
- Q.931 response message setting for inbound VoIP calls
- H.245 logical channel open timing selection function
- Start H.245 procedure support
- DTMF / Hook flash relay with H.245 alphanumeric / signal
- Secondary gatekeeper support
- Gatekeeper assignment according to the domain name
- Gatekeeper discovery with multicast
- Lightweight RRQ support
- Signaling TCP port assignment
- Resource threshold setting with RAI
- H.235 clear-token, crypto-token support
- canMapAlias support
- Technical prefix (supported prefix) support
- Public IP assignment in NAT environment

• SIP

- Gateway-based / Endpoint-based registration support
- Secondary proxy-server assignment function
- SIP signaling port change function
- SIP proxy server assignment according to the domain name
- T.38 real-time fax relay support
- DTMF relay support with RFC2833 / OPTION message
- Re-INVITE support

• MGCP

- Secondary call agent assignment function
- Default package assignment
- Announcement Server Package, Generic Media Package, Handset Package, Line Package, Trunk Package support
- MGCP call agent assignment according to the domain name
- T.38 real-time fax relay support
- DTMF relay support based on RFC2833



AP160 Dial-Up VoIP Gateway Product Overview

Voice over IP Service (cont.)

• Voice Codec

- G.711 A-Law, G.711 U-Law
- G.726 r16, G.726 r32
- G.729A
- G.723.1 r63, G.723.1 r53
- VAD (Voice Activity Detection) function support
- DTMF relay support (H.323, SIP, MGCP common) based on RFC2833

• RTP

- Redundant RTP packet transmission in case of severe packet loss
- Dynamic jitter buffer management and RTP packet jitter and loss compensation with heuristic & DSP error concealment
- Static jitter buffer setting support
- Voice frame per RTP packet number control for each codec
- In-band ring-back tone support
- Virtual ring-back tone support
- Tone parameter change support

VoIP

• FAX

- Fax relay mode supporting T.38, inband-T.38, bypass mode
- Lost packet compensation with redundant setting in case of T.38 fax relay
- Fax relay mode, rate setting for remote end

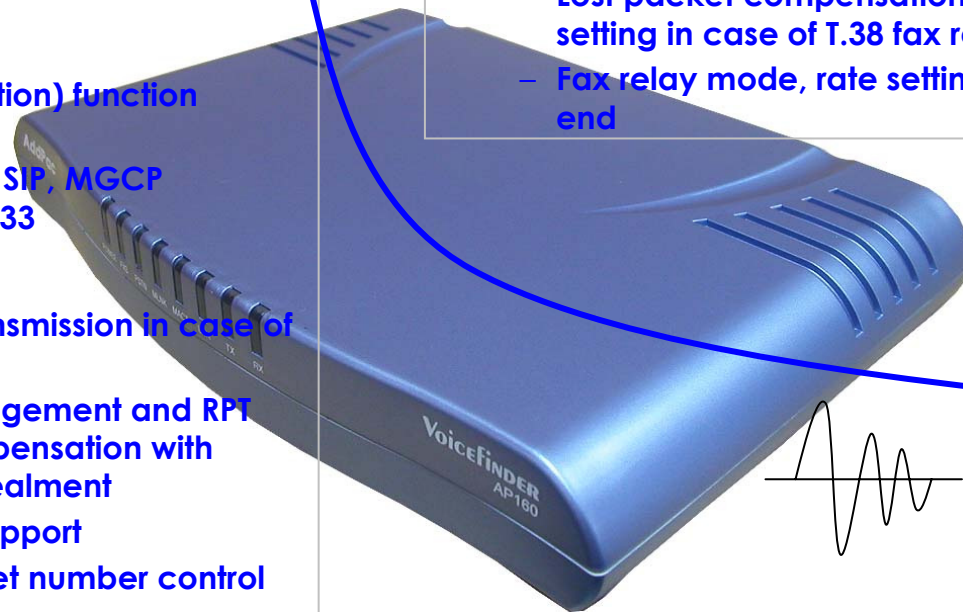

AP160 Dial-Up VoIP Gateway Product Overview

VoIP Call Managements

• VoIP Call Controls

- Hot line connection function with PLAR (Private Line Auto Ring Down)
- Leased line emulation function
- Connection monitoring function
- Fault tolerant with Redundancy and Call Distribution among Gateways for load balancing
- Call attempt with IP address
- H.323, SIP, MGCP inbound call connection for each voice port
- Multiple E.164 setting for one voice port
- One E.164 or digit pattern can be assigned to more than one voice port
- Hunting with Longest match/ priority/ sequence/ random
- One stage call setup by Digit forwarding
- Call barring with specific digit patterns
- Calling and called number conversion for PSTN outbound calls
- PSTN rerouting in case of VoIP call attempt failure

• VoIP Call Controls (cont.)

- Call transfer for internal calls
- Call pickup for internal calls
- Calling and called number conversion for VoIP outbound calls
- Calling and called number conversion for VoIP inbound calls
- Fax broadcasting call control

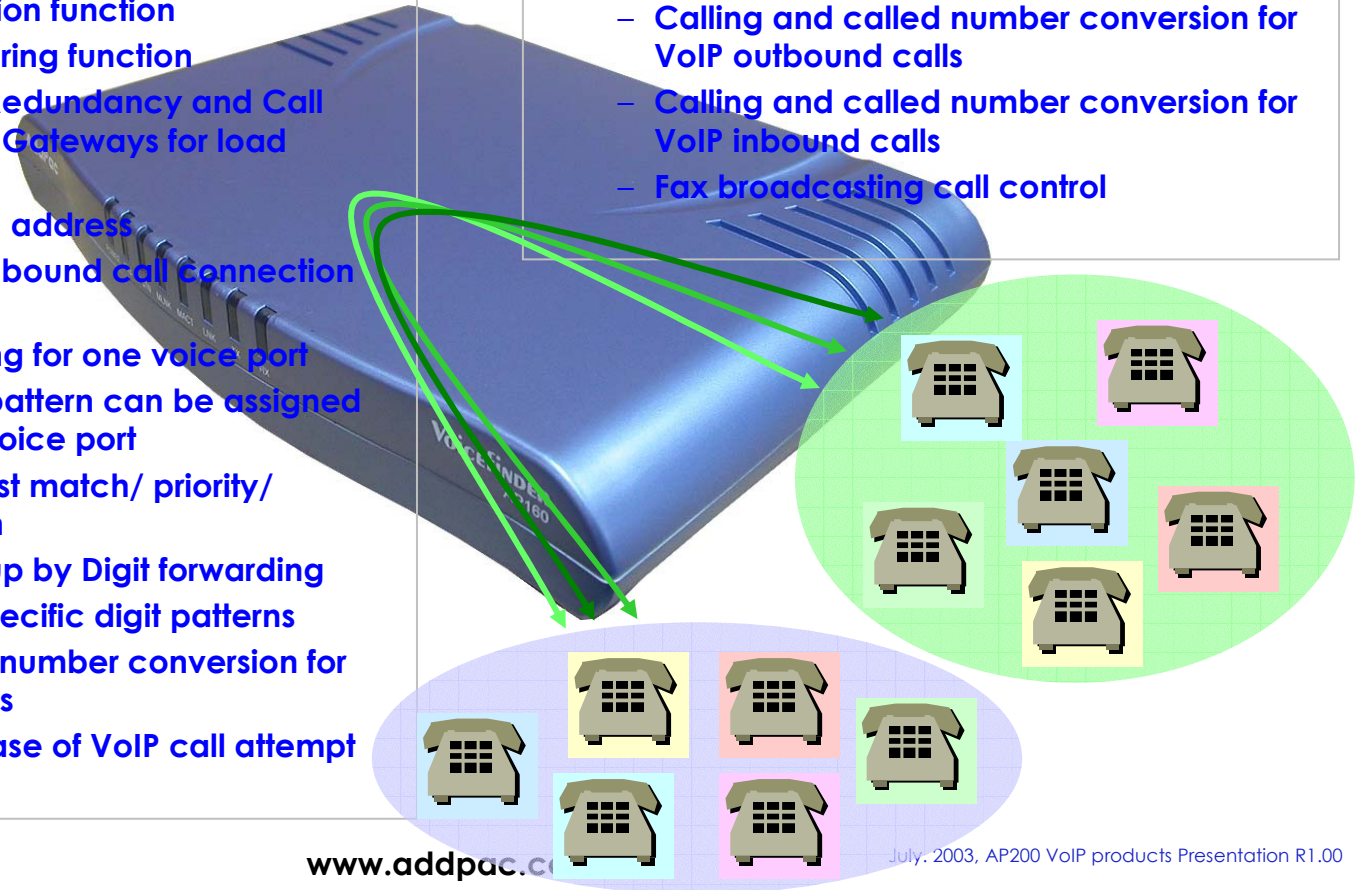

AP160 Dial-Up VoIP Gateway Product Overview

Enhances QoS Managements

• Enhances **Transmit** Voice QoS Features

- Voice Traffic Priority Queuing
- QoS Service Profiling
- Providing Virtual Network Transmit Algorithm
- Real-time Voice Traffic QoS Support
- RTP Packet Transmit Interval Control
- Supporting RTP Packet Redundancy Scheme
- IP Header Control such as ToS, Diffserv

• Enhances **Receive** Voice QoS Features

- Dynamic Jitter Buffer Management
- Error Concealment
- Support T.38 FAX Data Error Recovery Scheme

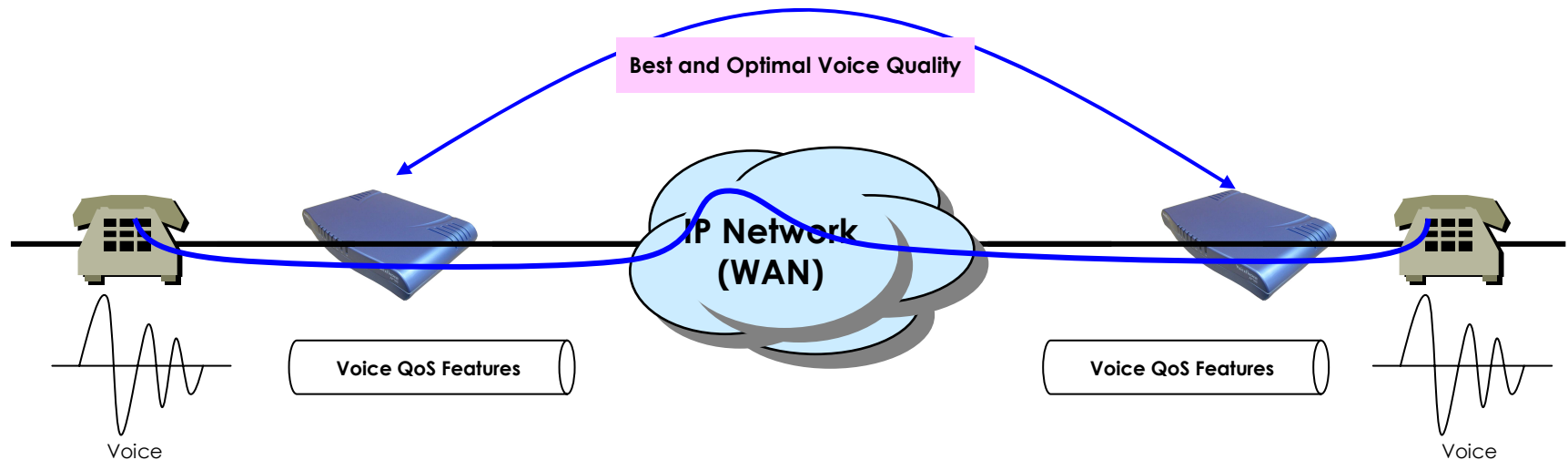

AP160 Dial-Up VoIP Gateway Product Overview

Enhances QoS Managements(Cont.)

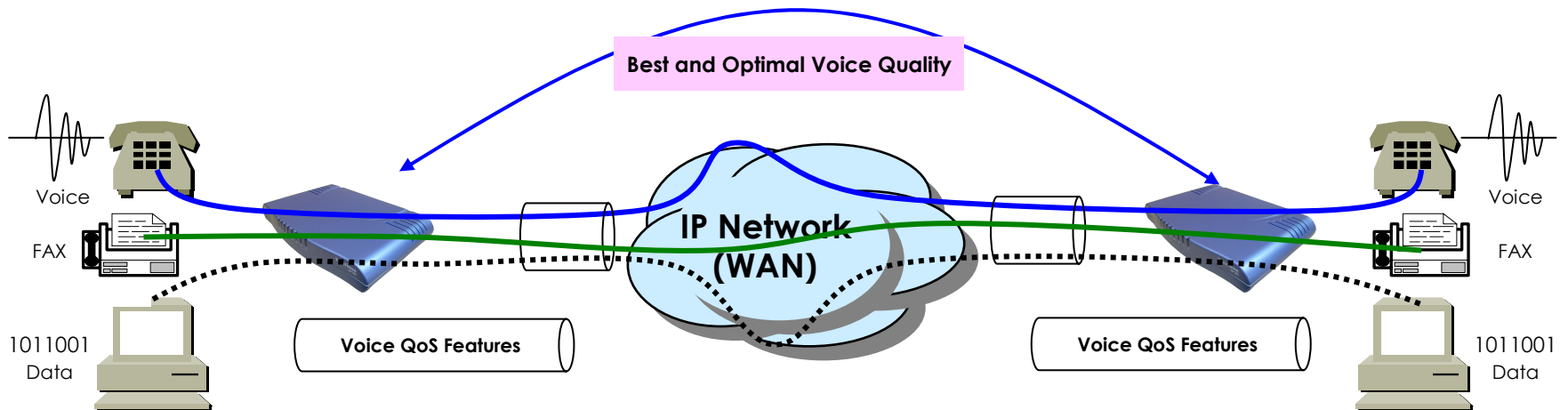
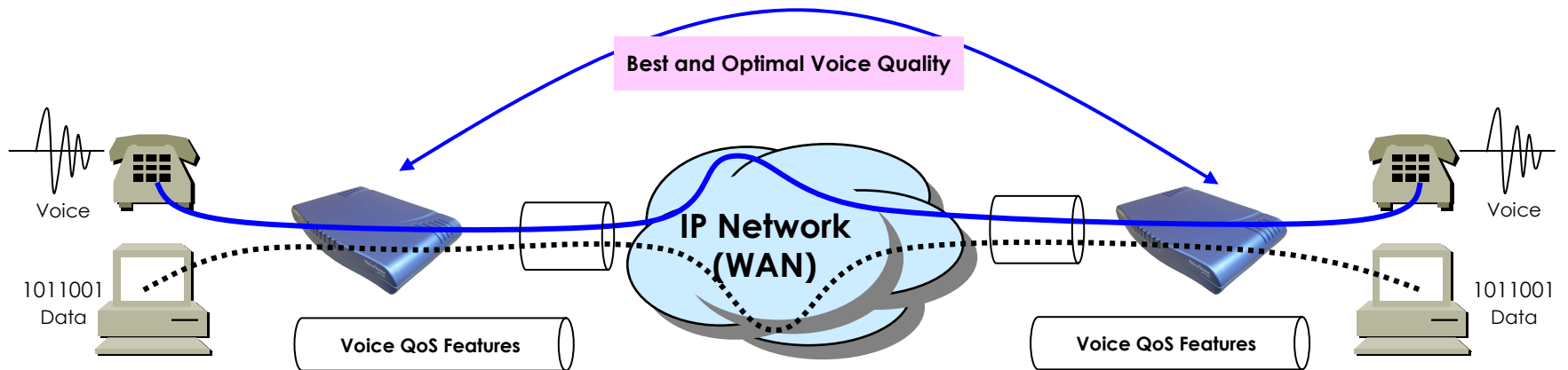

AP160 Dial-Up VoIP Gateway Product Overview

IP and WAN Protocols

- IP Routing Protocols

- Multi-protocol Internetworking Services
- Static IP routing
- Transparent Bridging (IEEE Spanning Tree Protocol)
- DHCP Client

- WAN Protocols

- Point-to-Point Protocol (PPP) over Dial-Up Access

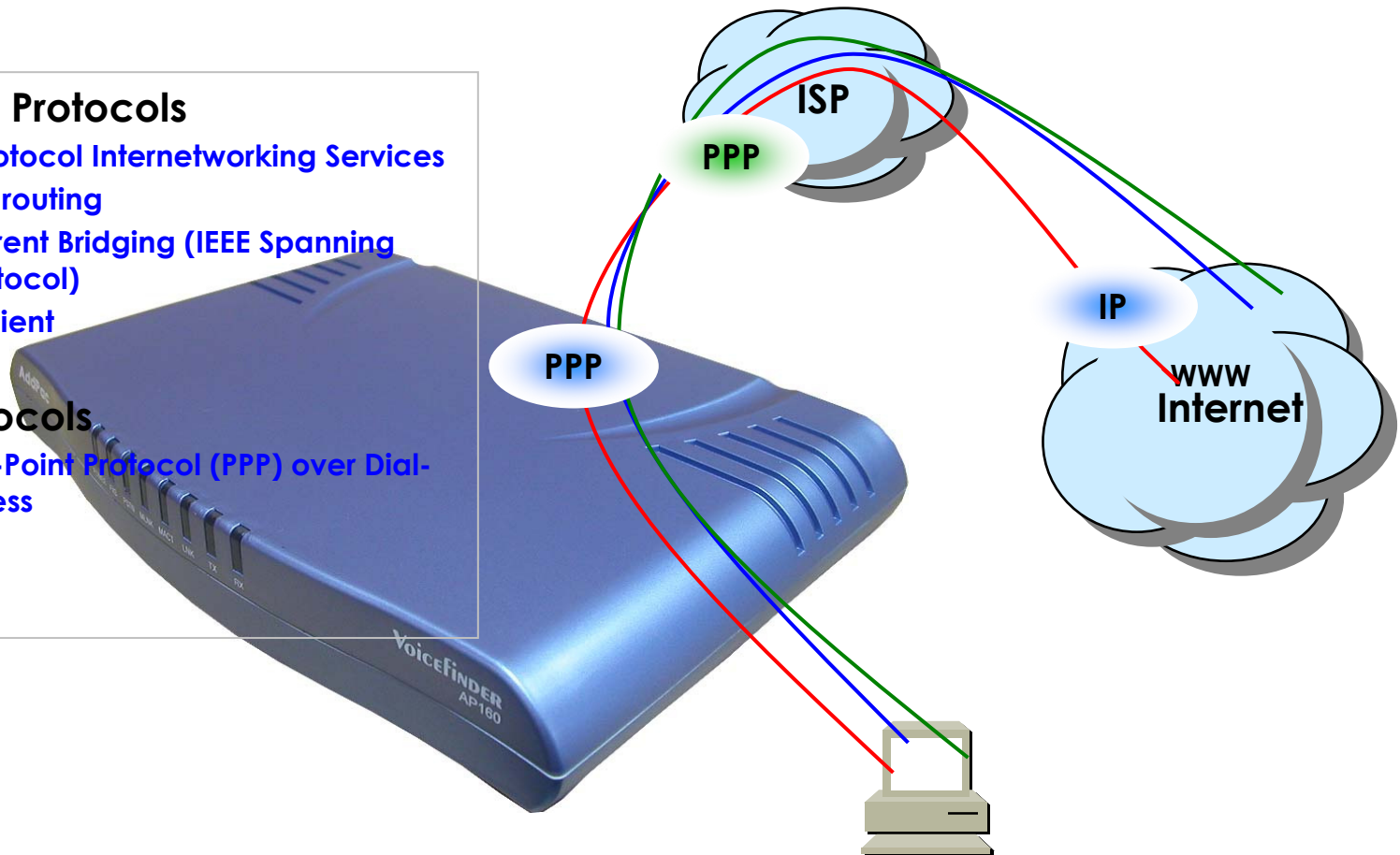

AP160 Dial-Up VoIP Gateway Product Overview

Network Managements

- **SNMP**

- Standard Simple Network Management Protocol(SNMP) Agent support
- MIB v1 and v2 Support

- **Web-based Management**

- Standard Voice Interface
- Standard PSTN Back-up Interface

- **Watch-dog Function**

- Hardware, Software watch-dog services

- **Remote Management**

- Telnet
- Rlogin
- Console

- **Auto Upgrade Service**

- HTTP server based APOS image and configuration file auto-upgrade support

- **Batch Job Function**

- Text based script downloading

- **Easy Set-up Service**

- MS Windows Graphical User Interface (GUI) based installation Software Solution
- Easy installation Set-up service

- **Interoperable with AP-VPMS Service**

- AddPac VoIP Plug & Play Management System (AP-VPMS)

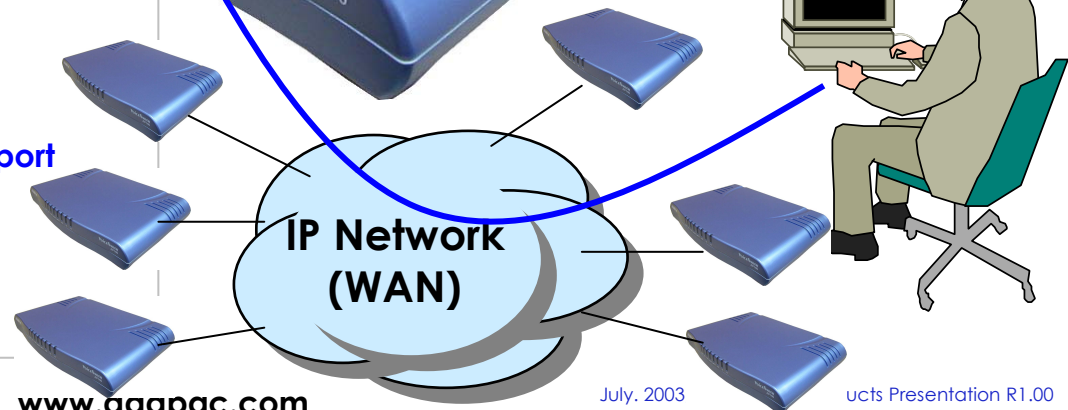
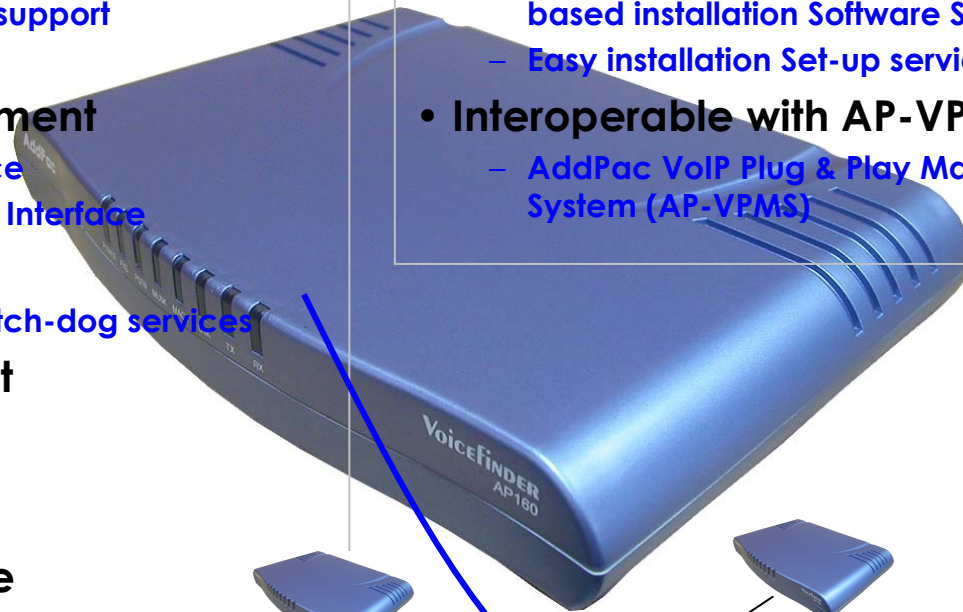

AP160 Dial-Up VoIP Gateway Product Overview

Security Managements

- IP packet filtering
- IP access list
- User authentication function
 - Password Authentication Protocol (PAP)
 - Challenge Handshake Authentication Protocol (CHAP)
- Enable/Disable specific protocols
- Auto-square connect of console and Telnet session
- Account Management function for multi-level user
- SNMP/TELNET/FTP/HTTP/TFTP port assignment function
- SNMP/TELNET/FTP access list management
- Boot mode security checking function

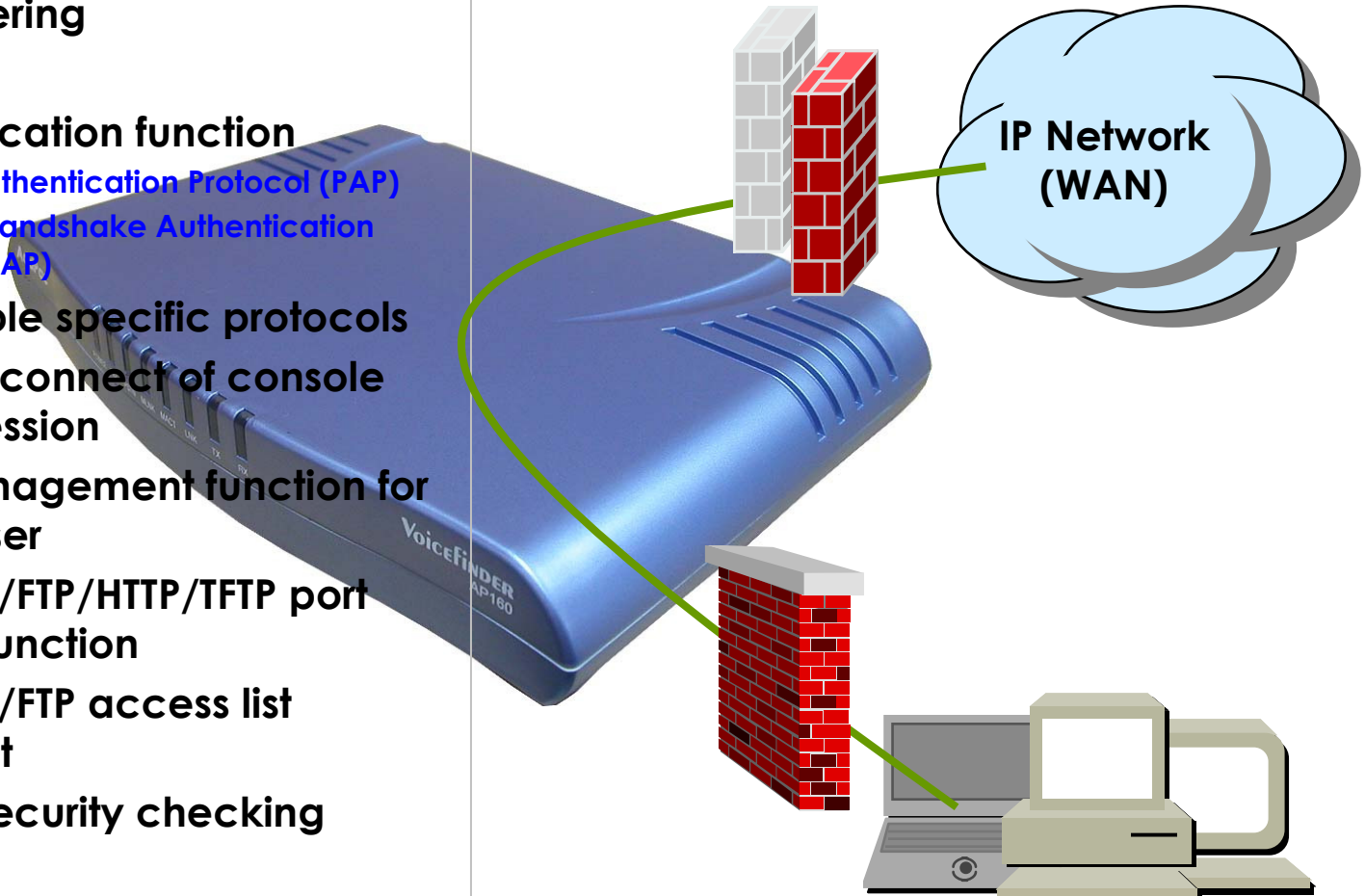

AP160 Dial-Up VoIP Gateway Product Overview

Network Scalability

- **IP Sharing Feature**

- Single IP Address Access
- Public IP Address Sharing by VoIP Gateway

- **IP Sharing Network Environment**

- Support Legacy Network Environment
- xDSL Modem based Broadband Network
- Cable Modem based Broadband Network
- Leased line Network Environment

- **Both support Fixed and Dynamic IP**

- **Support Standard Network Protocols**

- PPPoE
- DHCP



AP160 Dial-Up VoIP Gateway

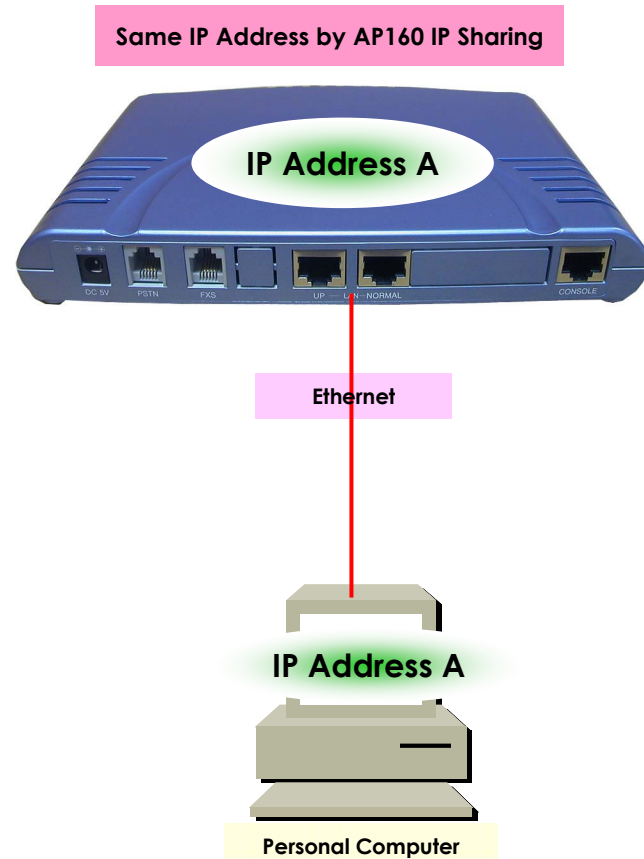

AP160 Dial-Up VoIP Gateway Product Overview

Network Scalability (cont.)

- **Bridging Service**
 - Spanning Tree Bridging protocol (IEEE) support
- **DHCP**
 - Server and Relay
- **IP Accounting**
- **PAT (Port Address Translation)**
- **NAT (Network Address Translation)**
- **Cisco Style CLI (Command Line Interface)**
- **PPTP (Point-to-Point Tunneling Protocol)**
- **NTP (Network Time Protocol)**
- **FTP/TFTP**
 - Server and Client support
- **DNS**
 - Dynamic DNS Client support

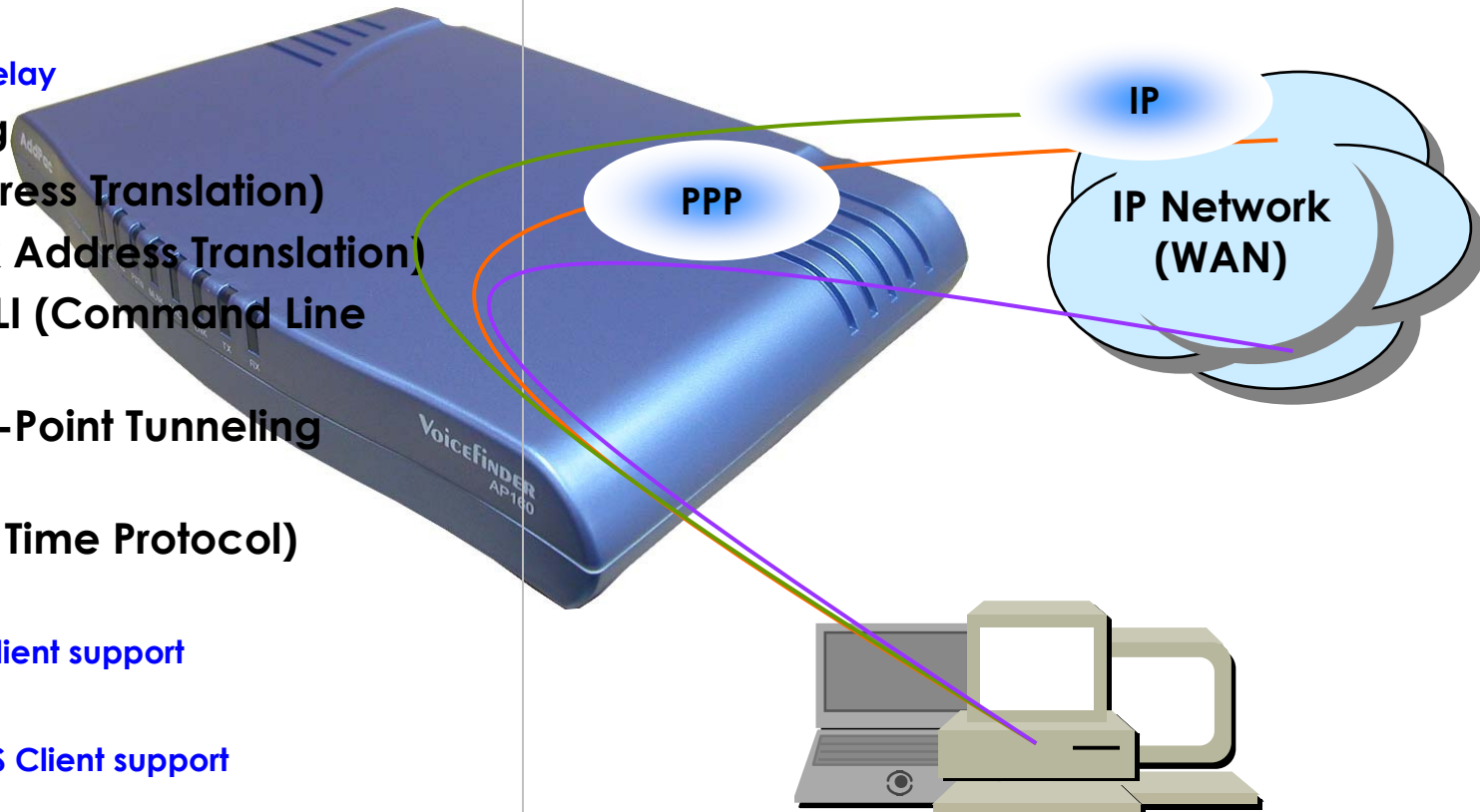

AP160 Dial-Up VoIP Gateway Product Overview

VoIP Gateway Easy Setup Configuration

- AddPac Dial-Up modem Easy Setup Program
 - Setup Program exclusively for AP160
 - Easy installation Set-up service
 - GUI Program on Windows
 - Available connection type are Serial Mode and TCP/IP
 - Auto upgrade function of APOS image or script



AP160 Dial-Up VoIP Gateway Product Overview

VoIP Plug & Play System (VPMS)

- **AddPac AP-VPMS Support**
 - AddPac VoIP Plug & Play System (VPMS)
 - Best EMS Solutions for AddPac VoIP G/W
- **Requirements Hardware Platform**
 - Over 1GHz Intel Pentium 4 Machine
 - Over 1GB Main Memory
 - Over 40GB Hard Disk Memory
 - Microsoft Windows Advanced Server or Windows 2000 Server or Windows XP Professional
 - DBMS : Microsoft MS-SQL Server 2000

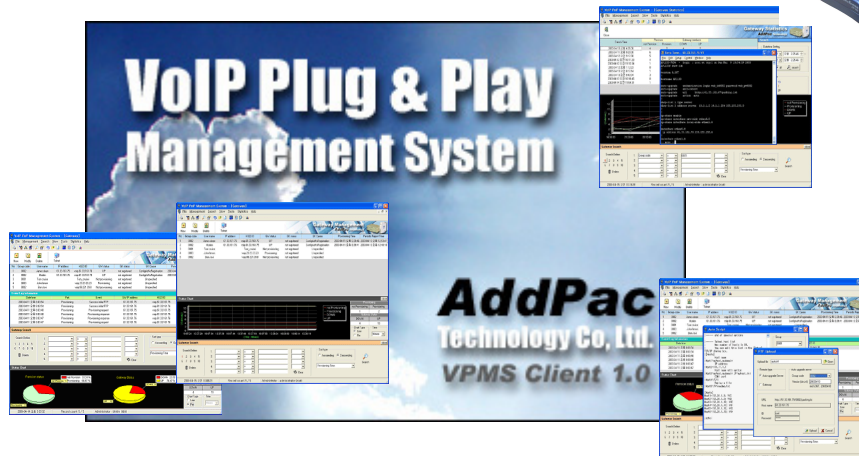
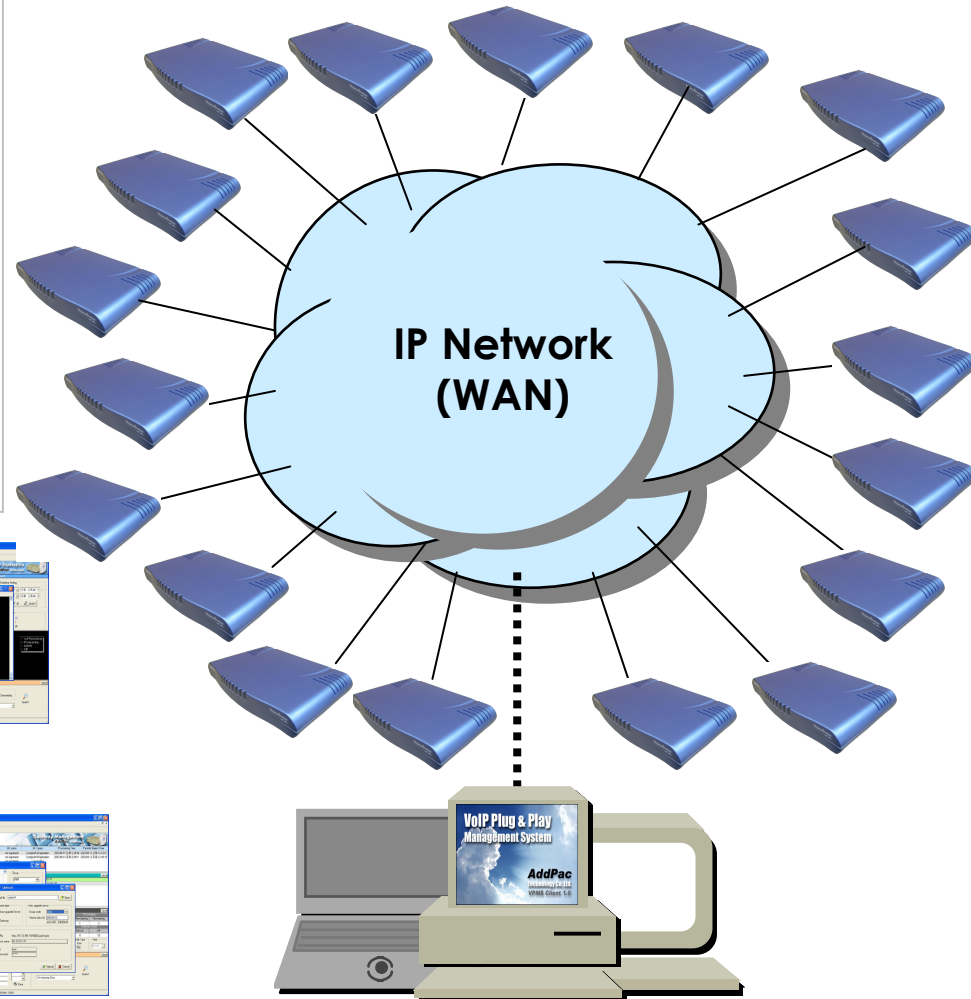

AP160 Dial-Up VoIP Gateway Product Overview

AP160 Hardware Specification

Hardware Specifications

AP160 VoIP Series	Basic Specifications
CPU	32Bit RISC Microprocessor
Voice Interface	1-Port FXS Voice Interface(RJ-11)
Ethernet Interface	1-Ports 10Mbps Ethernet Interface(RJ-45)
Console Port	1-Port RS-232C Console Port(RJ-45)
PSTN Port	1-Port PSTN Port(RJ-11)
Flash Memory	2Mbyte High-speed Flash Memory
Base Memory	16Mbyte High-speed SDRAM
Boot Memory	512Kbyte Flash Memory
Power Requirement	External Power Supply Adaptor / VAC 110~220V, 50/60Hz, 5Watt
Operating Temperature	0°C ~ 45°C (32 °F ~ 112°F)
Storage Temperature	-40°C ~ 85°C (-40°C ~ 185°F)
Relative Humidity	5% ~ 95% (Non-condensing)
Dimensions	26mm x 200mm x 137mm (H x W x D)
Weight (g)	400g

Network interface Configurations

AP160 Dial-Up VoIP G/W

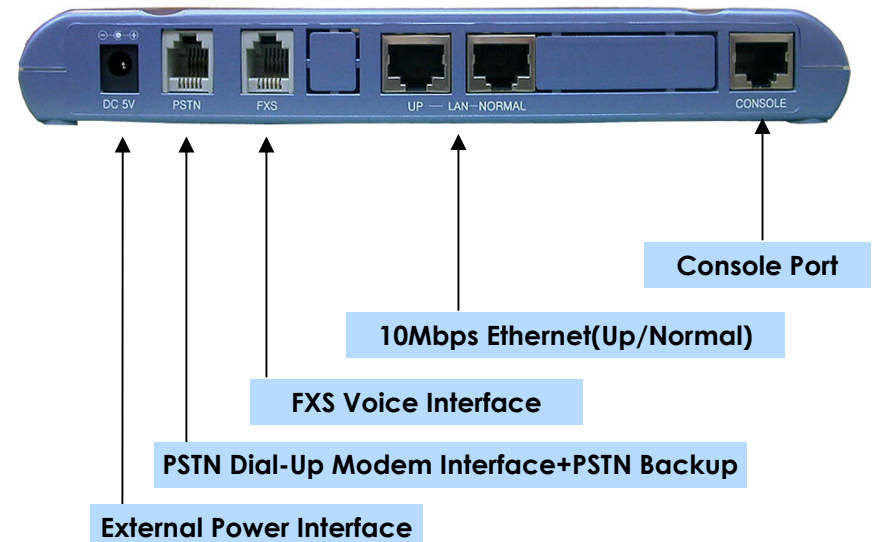

AP160 Dial-Up VoIP Gateway Product Overview

AP160 Networking Interface

- **High-performance Hardware**

- 32bit RISC Microprocessor Architecture
- High-performance DSP Architecture
- High-speed Memory with Boot Loader
- Dual Ethernet Interface for WAN & LAN
- Standard FXS Voice Interface
- Standard PSTN Dial-up Interface
- RS-232C Console Interface

- **Compact Design**

- Small, Light, and Compact Design





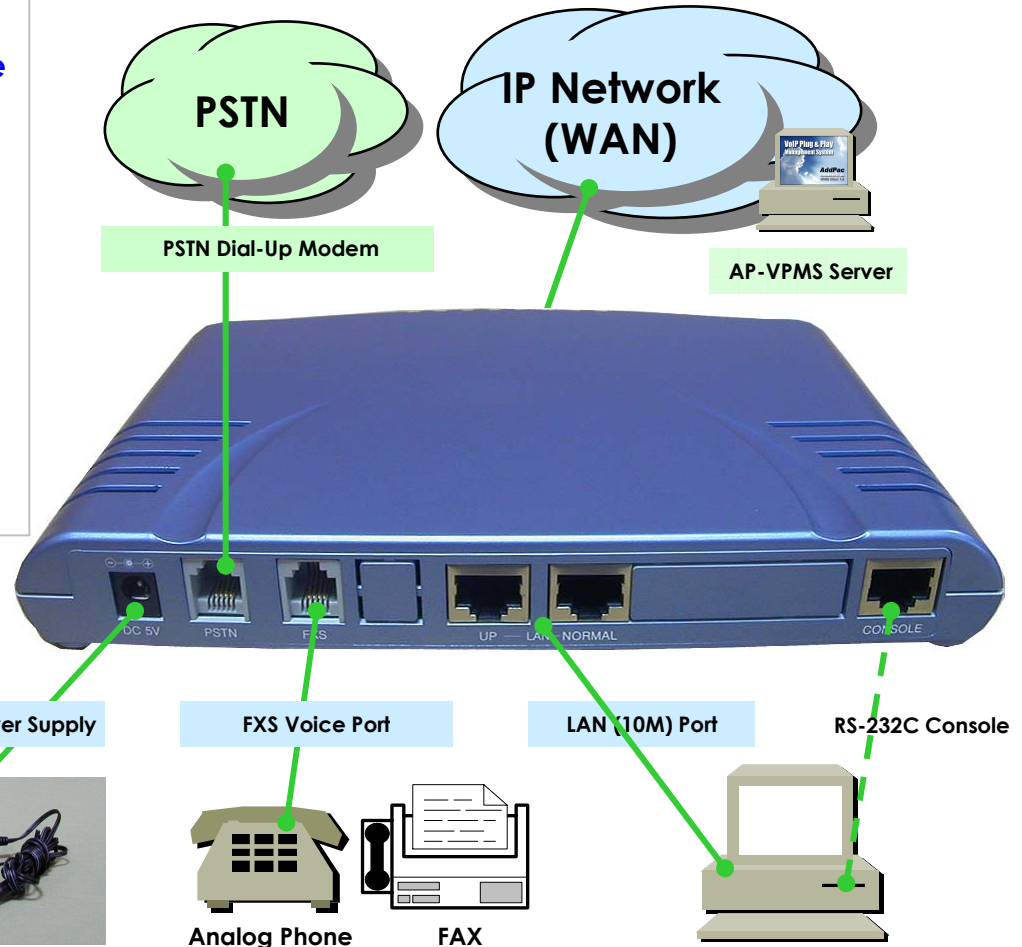

AP160 Dial-Up VoIP Gateway

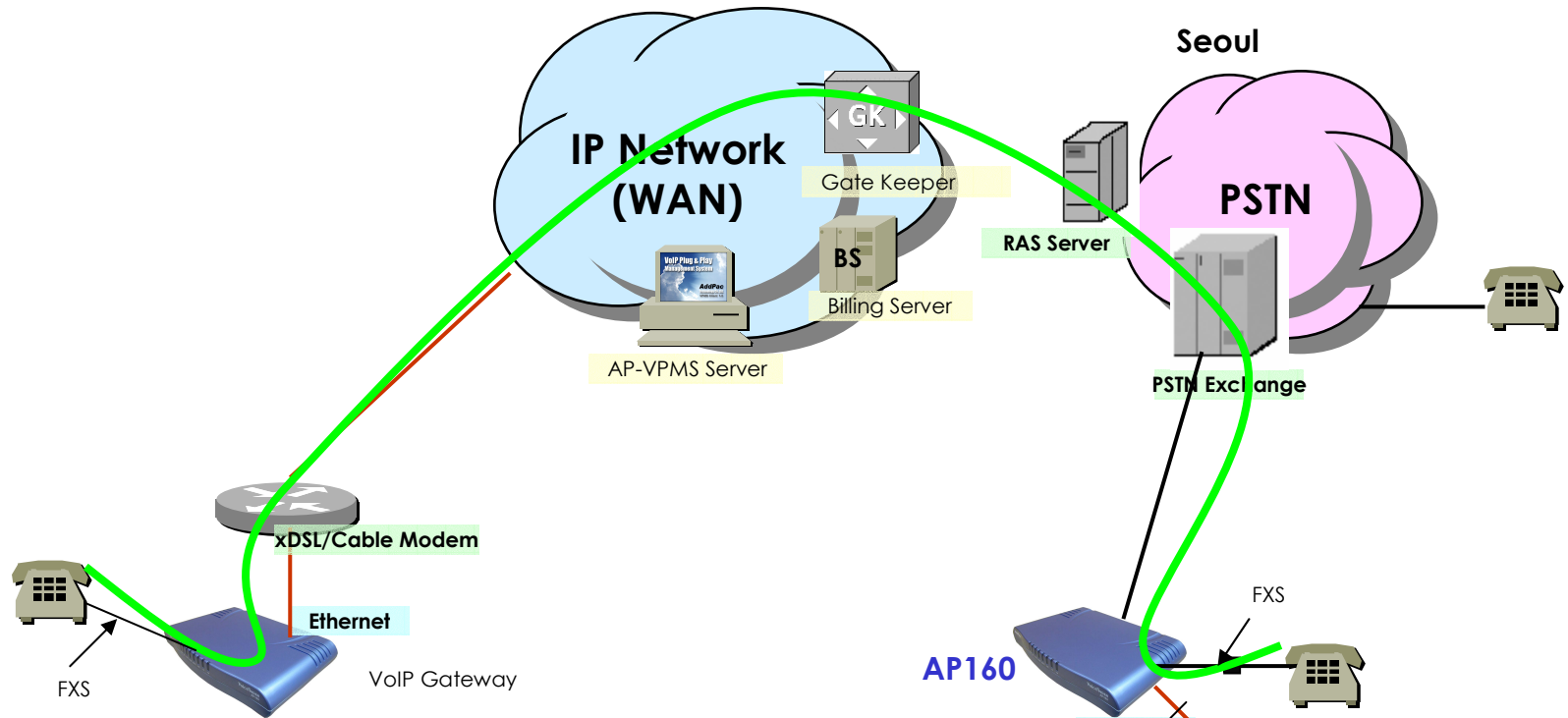

AP160 Voice Networking Configuration



Dial-Up VoIP Service via PSTN Modem

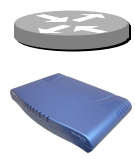

-  FXS Analog Voice Interface
-  FXO Analog Voice Interface
-  Ethernet or WAN Interface

 TRUNK n x E1 Voice Interface for PSTN Interworking



-  xDSL/Cable Modem, etc.
-  AddPac AP160 Voice over IP Gateway Series

 Voice Flow



www.addpac.com

AP160 Voice Networking Configuration

VoIP Service via xDSL Modem

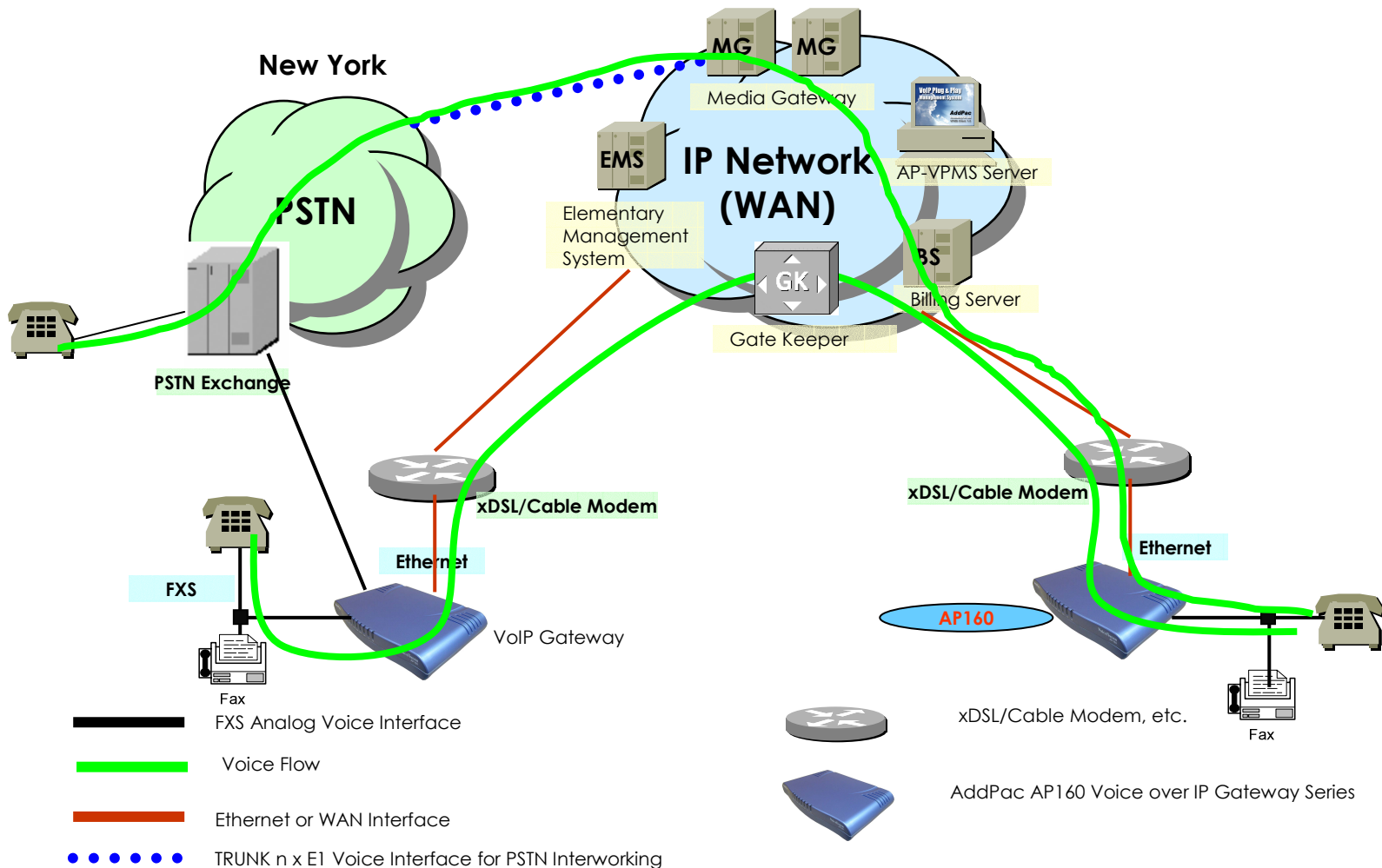

— FXS Analog Voice Interface

— Voice Flow

— Ethernet or WAN Interface

••••• TRUNK n x E1 Voice Interface for PSTN Interworking



www.addpac.com

July, 2003, AP200 VoIP products Presentation R1.00

AP160 Voice Networking Configuration

PSTN Backup Service

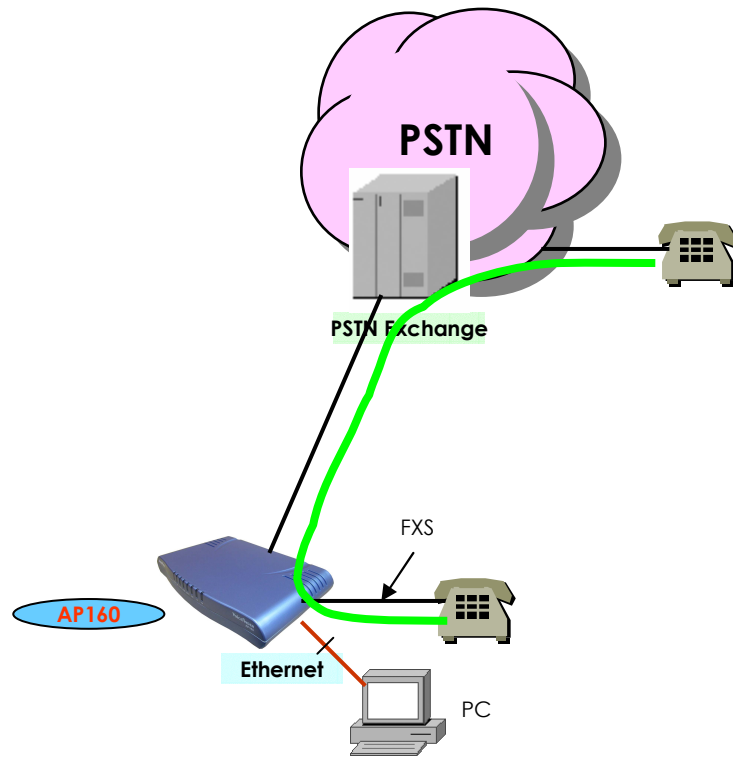

— FXS Analog Voice Interface

— FXO Analog Voice Interface

— Ethernet or WAN Interface

••••• TRUNK n x E1 Voice Interface for PSTN Interworking



xDSL/Cable Modem, etc.



AddPac AP160 Voice over IP Gateway Series



Voice Flow

AP160 VoIP Gateway Product Overview

AP160 World-Wide Customer Site

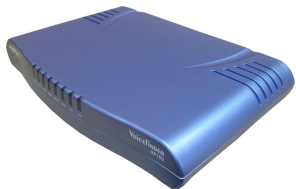
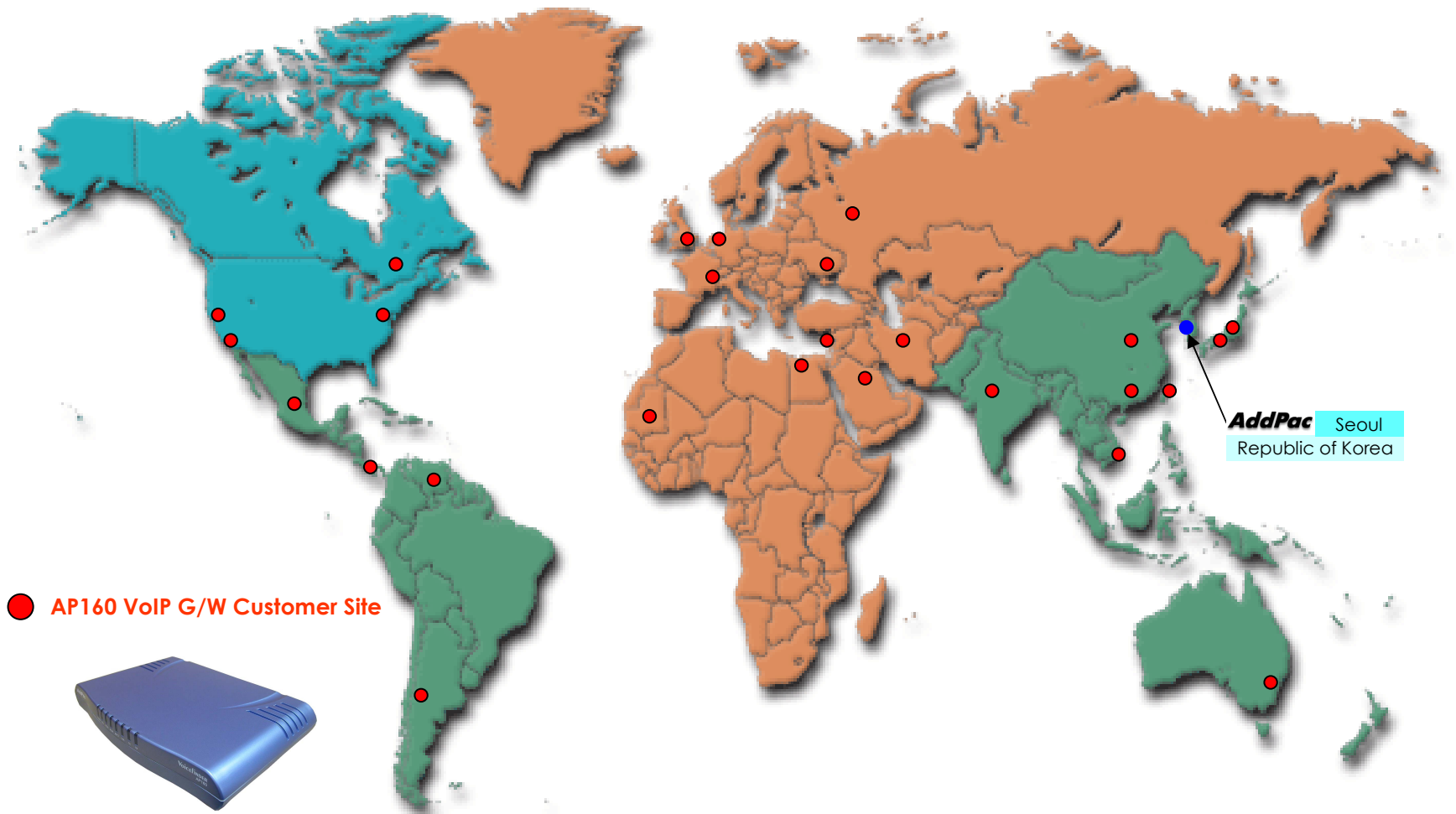

AP160 Dial-Up VoIP Gateway Product Overview

AP160 Ordering and Pricing

• AP160 Dial-Up VoIP Gateway Series

– Order No:

AP160 Dial-Up VoIP Gateway

Hardware

- High-speed 32bit RISC CPU
- 1-Ports FXS Voice port Configuration
- 1-Ports Ethernet
- 1-Port PSTN Dial-Up Modem+PSTN Backup
- 1-Port RS-232C Console
- Including Network Cable Set

– Built-in APOS Internetworking Software

– Including 1-Year Hardware Warranty

– Product Documents

- Installation Guide (PDF)
- Quick APOS Operation Guide (PDF)
- APOS Operation Guide (PDF)

• Pricing

– AddPac Technology Regional Sales Managers

– Authorized Sales and Marketing Representatives

– Please Contact www.addpac.com

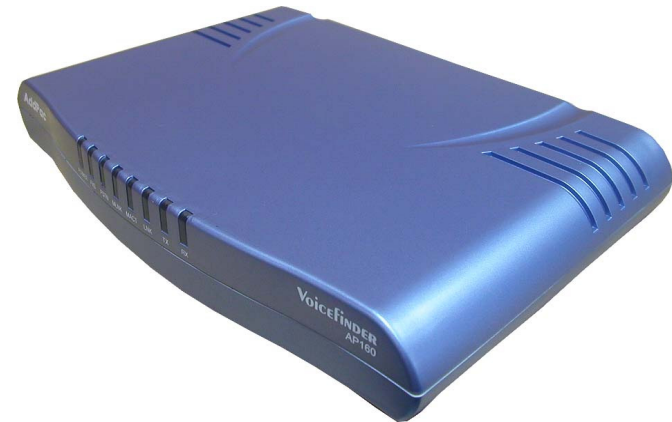

AddPac Technology Co., Ltd.

Thank you !

www.addpac.com

Technical Sales and Marketing

Phone : +82 2 568 3848

Fax : +82 2 568 3847

sales@addpac.com