

AP160 Dial-Up VoIP Gateway Design Features & Concept

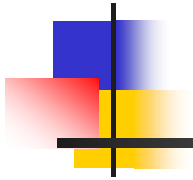

2003. 2.

AddPac Technology

R&D Center

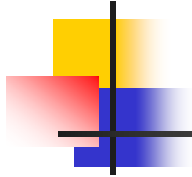

Contents

- Design Features**
- Design Block Diagram**
- Design Specifications**
- AP160 Series Easy Setup Concept**
- Discussion**

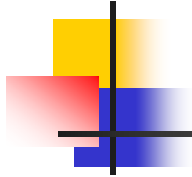

Design Features

AP160 Series Specific H/W Features

- AP160-FX1 : 1 FXS Port, LAN0 (optional)

AP160 Series Common H/W Features

- CPU : 32Bit RISC Microprocessor
- DSP : High Performance DSP
- Main Memory : 16Mbyte SDRAM
- Flash Memory : 2Mbyte
- One(1) PSTN + Modem Port
- Console Port : RJ-45
- Real Time Clock

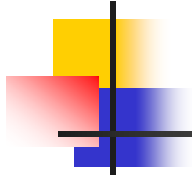

Design Features

□ AP160-FXS1

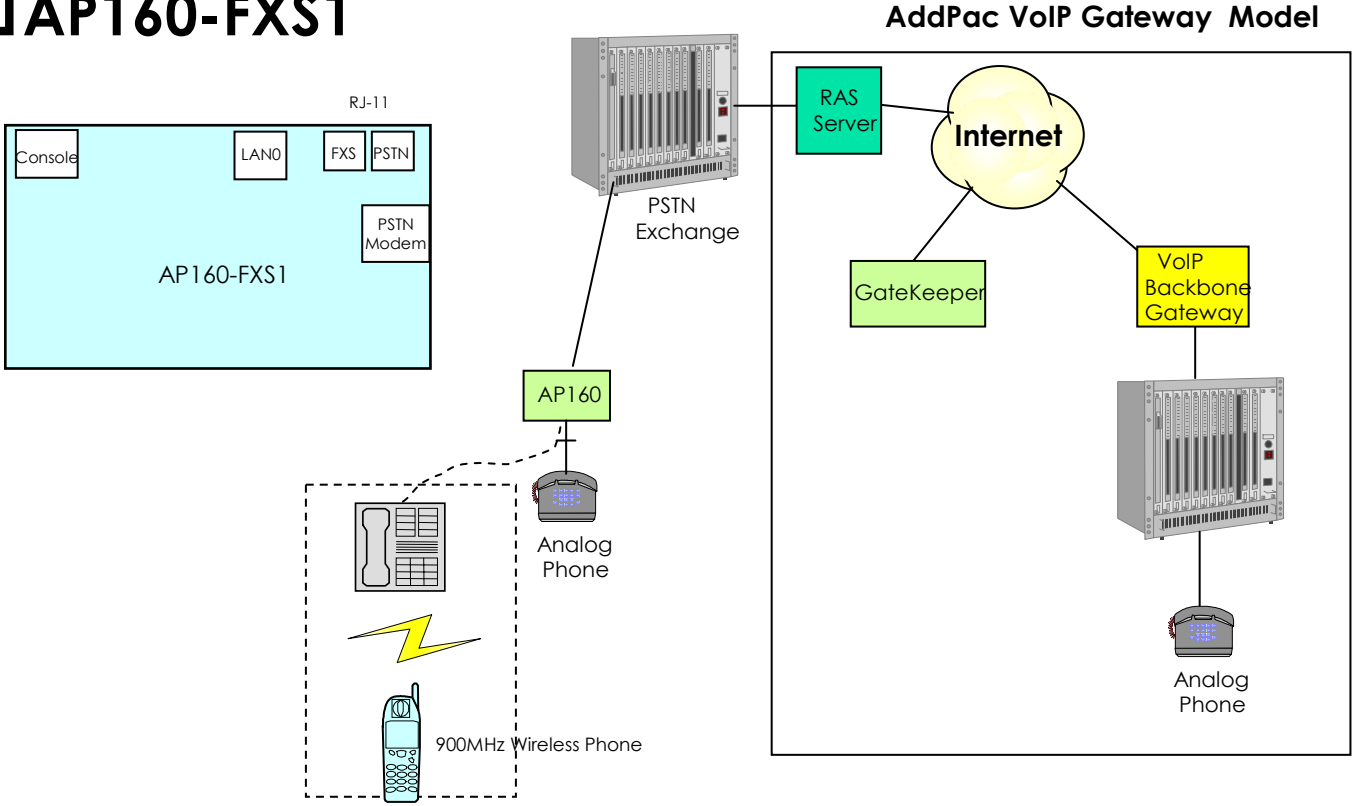

Design Features

System Block Diagram (Logical Diagram)

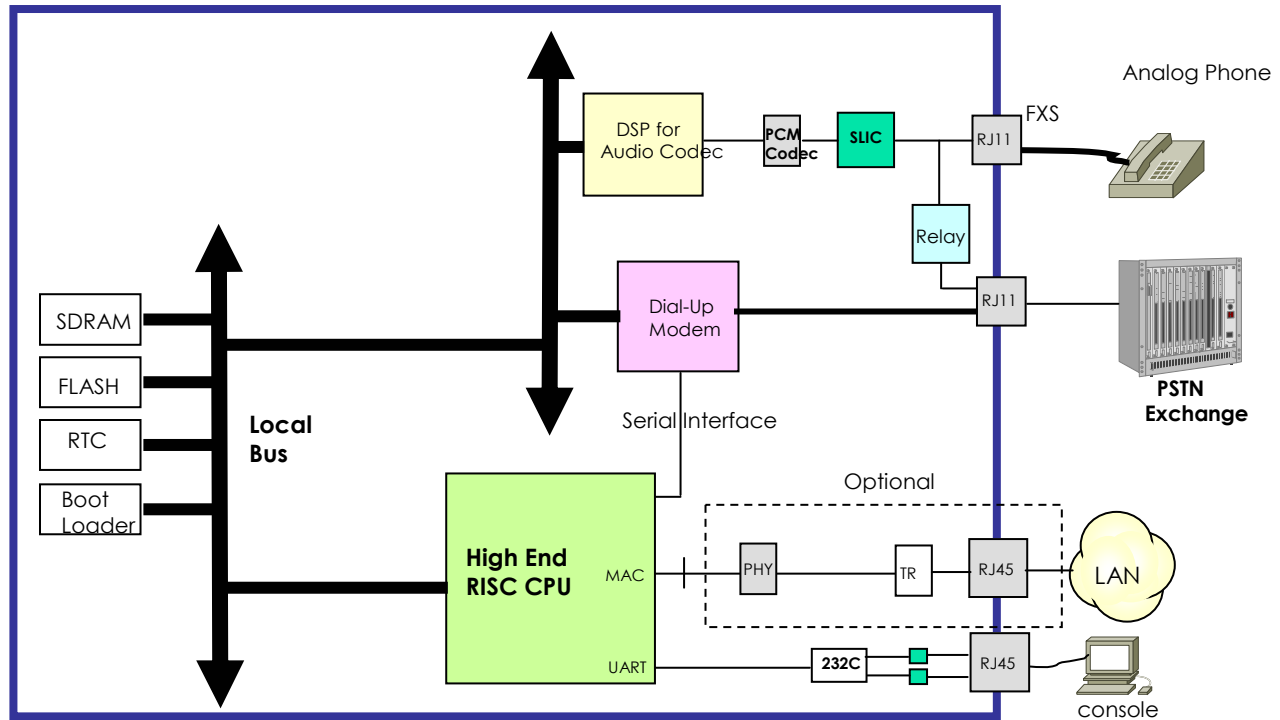



Design Specifications

□ AP160 Series Specification

WAN Protocols	Point-to-Point Protocol(PPP) for Dial-up modm
Voice over IP Services	ITU-T H.323 v2 VoIP protocol with ITU-T H.235 Security Features
	G.723,G.729A,G.711 Voice Compression
	Voice Processing Features : VAD, DTMF, CNG,G.168 and T.38 Fax Relay
	Enhanced QoS Management Features for Voice Traffics
Network Managements	Standard SNMP Agent (MIB v2) Support
	Remote Management using Console, Rlogin, Telnet
	Web based Managements using HTTP Server Interface
	Traffic Queuing
Security Functions	Standard & Extended IP Access List
	Enable/Disable for Specific Protocols
	PPP User Authentication Supports : PAP, CHAP
Operation & Management	System Performance Analysis for Process, CPU, Connection I/F
	Configuration Backup & Restore for APOS Management
	Debugging, System Auditing, and Diagnostic Support
	System Booting and Auto-rebooting with Watchdog Feature
	System Managements with Data Logging
	IP Traffic Statistics with Accounting



Design Specifications

□ AP160 Series S/W Features (continue..)

Other Usable Features	DHCP Server & Relay Functions
	Network Address Translation (NAT) Function
	Port Address Translation(PAT) Function
	Transparent Bridging (IEEE Standard) Function - Spanning Tree Bridging Protocol Support - Remote Bridging Support - Concurrent Routing and Bridging Support
	Command Line Interface(CLI)
	Remote Upgrade for APOS management using FTP/TFTP

AP160 Series PSTN Inter-Working

□ PSTN Inter-Working Architecture

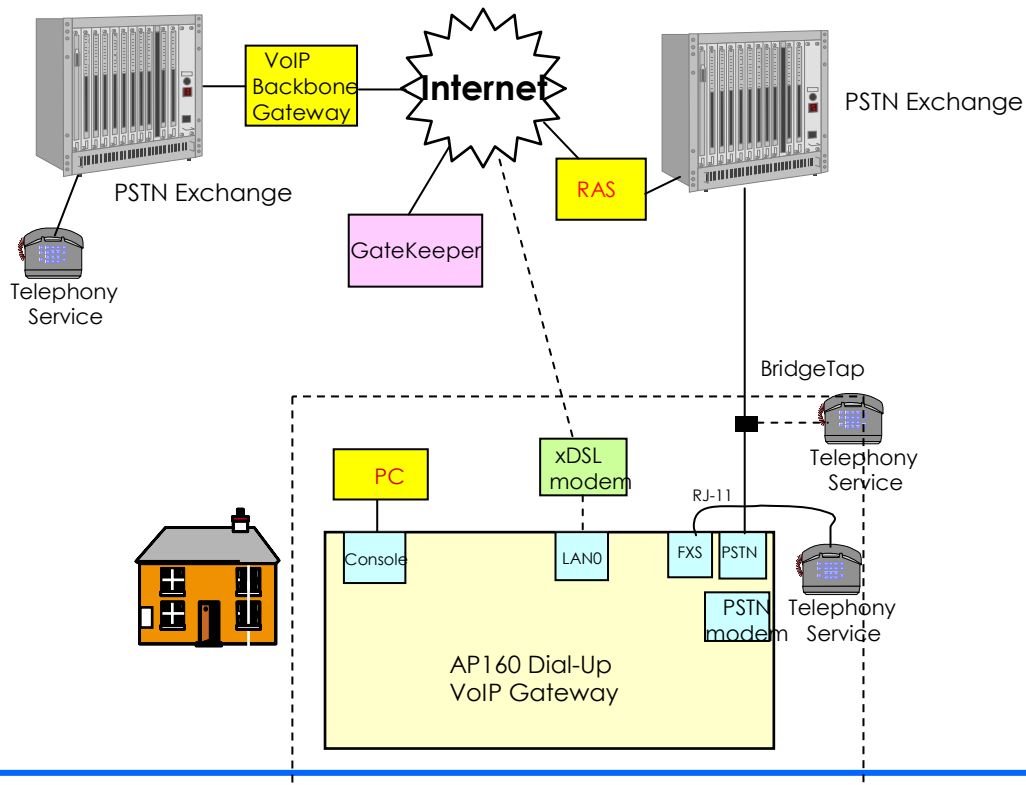

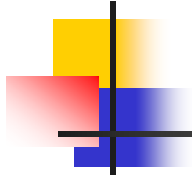

Discussion
