

# AP1605™

## IP Audio Broadcasting Terminal

High Performance IP Audio Broadcasting Terminal



MBMS Management Software



AP1605 IP Audio Broadcasting Terminal



AP-ABS5000 Broadcasting Server

# **AddPac**

## **AddPac Technology**

2011, Sales and Marketing

[www.addpac.com](http://www.addpac.com)

# Contents

- Product Overview
- Product Highlight
- Hardware Specification
- APOS™ Service Features
- IP Audio Broadcasting Signal Flow
- Unicast & Multicast Service Feature
- MBMS v2.0 Software Features
- IP Audio Broadcasting Solution
- Application Area
- Ordering Information

# Product Overview

## AP1605 IP Audio Broadcasting Terminal

- IP based Audio Broadcasting Terminal Solution
- Hardware Architecture for Audio Broadcasting Terminal Service
- One(1) Module Slot for Audio Encoding & Decoding Service
- Remote Broadcasting Service at terminal side
- High Quality Audio Codec Support (High Quality Codec, G.711, etc)
- Unicast and Multicast Broadcasting Scheme
- Enhanced MBMS (Multimedia Broadcasting Management System) Support
- One(1) channel Audio IN/OUT Port
- **Optional Built-In Digital AMP.**
- On-AIR Blue LAMP
- **Volume Control Rotary Switch at front panel**
- High-Quality Audio/Voice Service
- Firmware Upgradeable Architecture
- Broadcasting Solution with Outstanding Network Service Capability

# Product Highlights

## AP1605 IP Audio Broadcasting Terminal

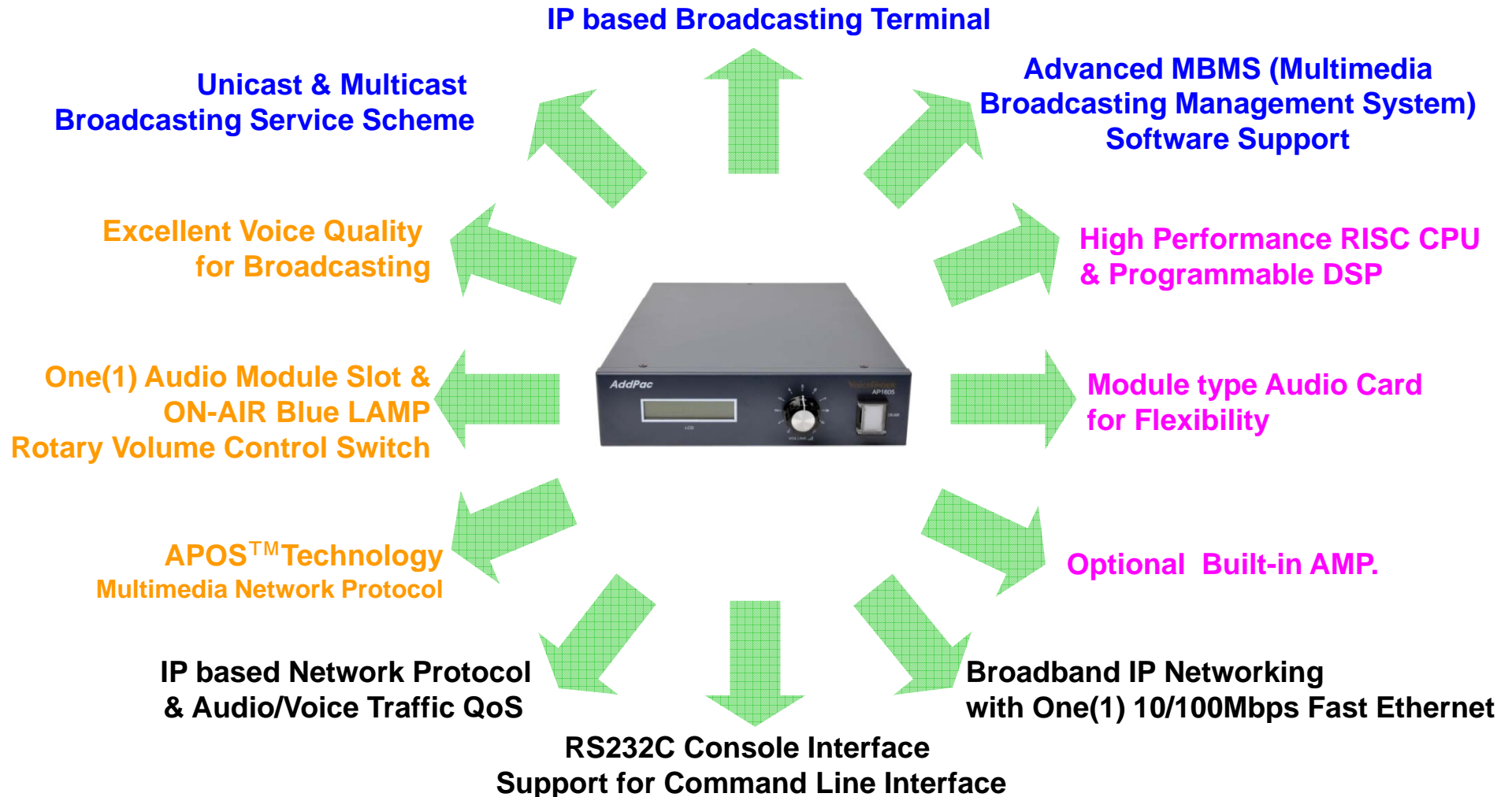

# Hardware Specification

## AP1605 IP Audio Broadcasting Terminal

RISC  
CPU

High-end  
DSP

- RISC Microprocessor Computing Power
- High-end Programmable DSP Hardware Architecture
- One(1) Module Slot for Audio Broadcasting Codec Module
- High Quality Audio Encoding/Decoding Service
- ON-AIR Blue LAMP
- Rotary Volume Control Switch
- Option Module : AP-N3-HQA1000
  - One(1) 10/100Mbps Fast Ethernet (RJ45)
  - One(1) RS-232C Interface (RJ45) for Command Line Interface
  - Stereo Audio Input/Output Connector
- Option Module : AP-N3-HQA1000A
  - One(1) 10/100Mbps Fast Ethernet (RJ45)
  - One(1) RS-232C Interface (RJ45) for Command Line Interface
  - Stereo Audio Input/Output Connector
  - Built-in Audio AMP.

# Hardware Specification

AP1605 IP Audio Broadcasting Terminal

RISC  
CPU

High-end  
DSP

## AP1605 Front Side



Status LCD

Rotary Volume  
Control Switch

On-Air Blue LAMP

**AddPac**

[www.addpac.com](http://www.addpac.com)

# Hardware Specification

AP1605 IP Audio Broadcasting Terminal

RISC  
CPU

High-end  
DSP

## AP1605 Back Side

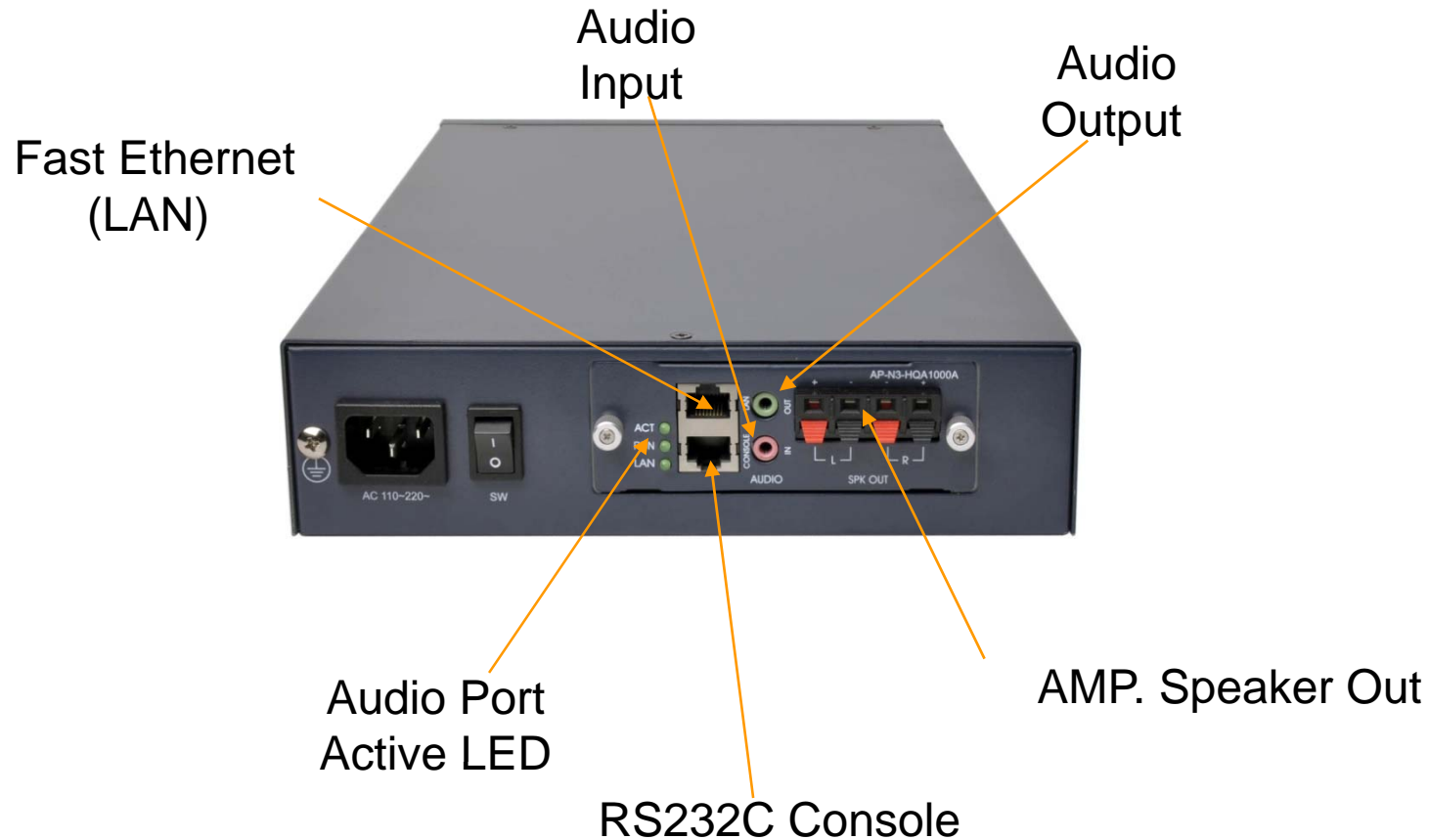

# Hardware Specification

AP1605 IP Audio Broadcasting Terminal

RISC  
CPU

High-end  
DSP

## AP-N3-HQA1000 Board

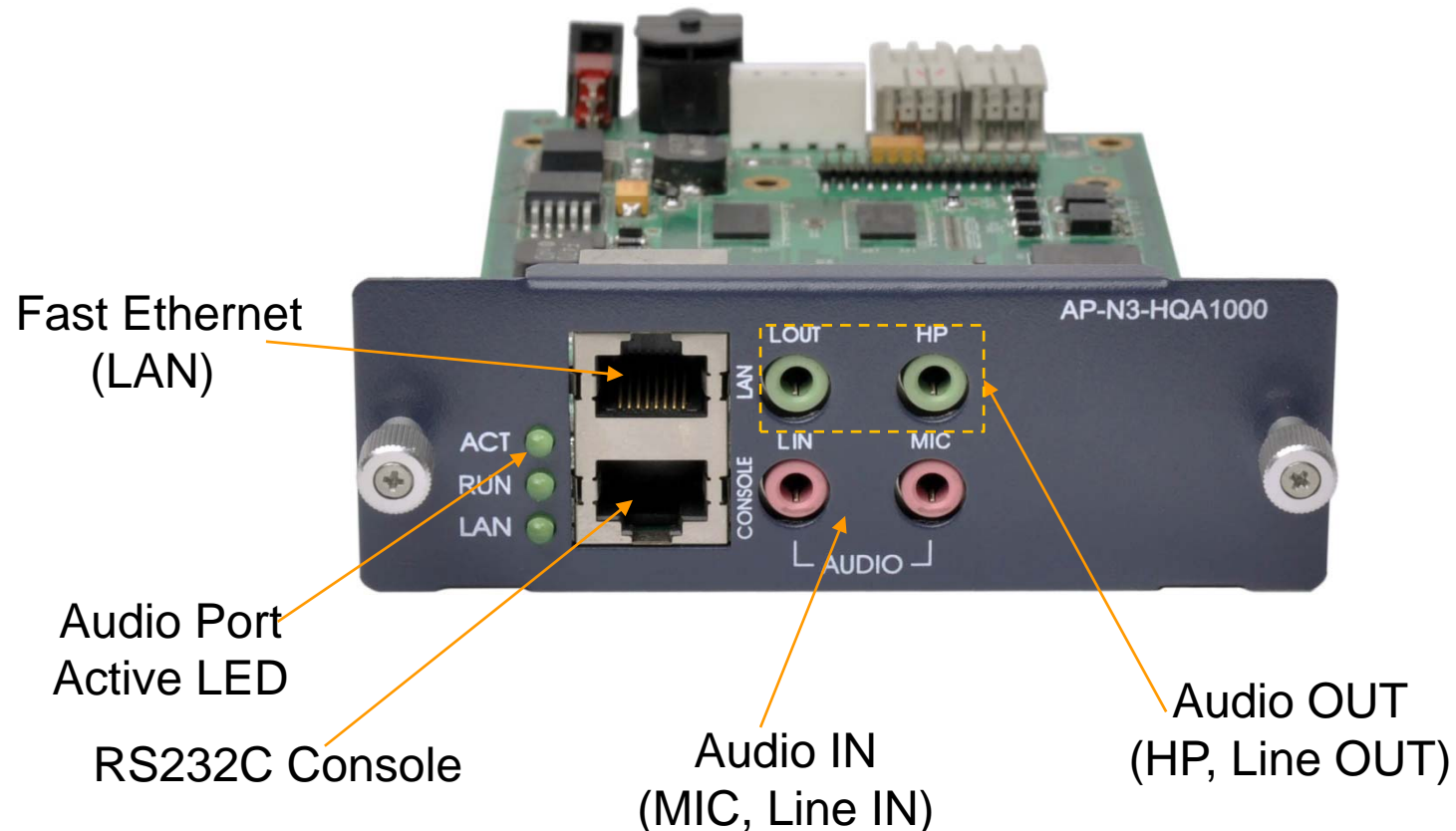

**AddPac**

[www.addpac.com](http://www.addpac.com)



# Hardware Specification

AP1605 IP Audio Broadcasting Terminal

RISC  
CPU

High-end  
DSP

## AP-N3-HQA1000A Board

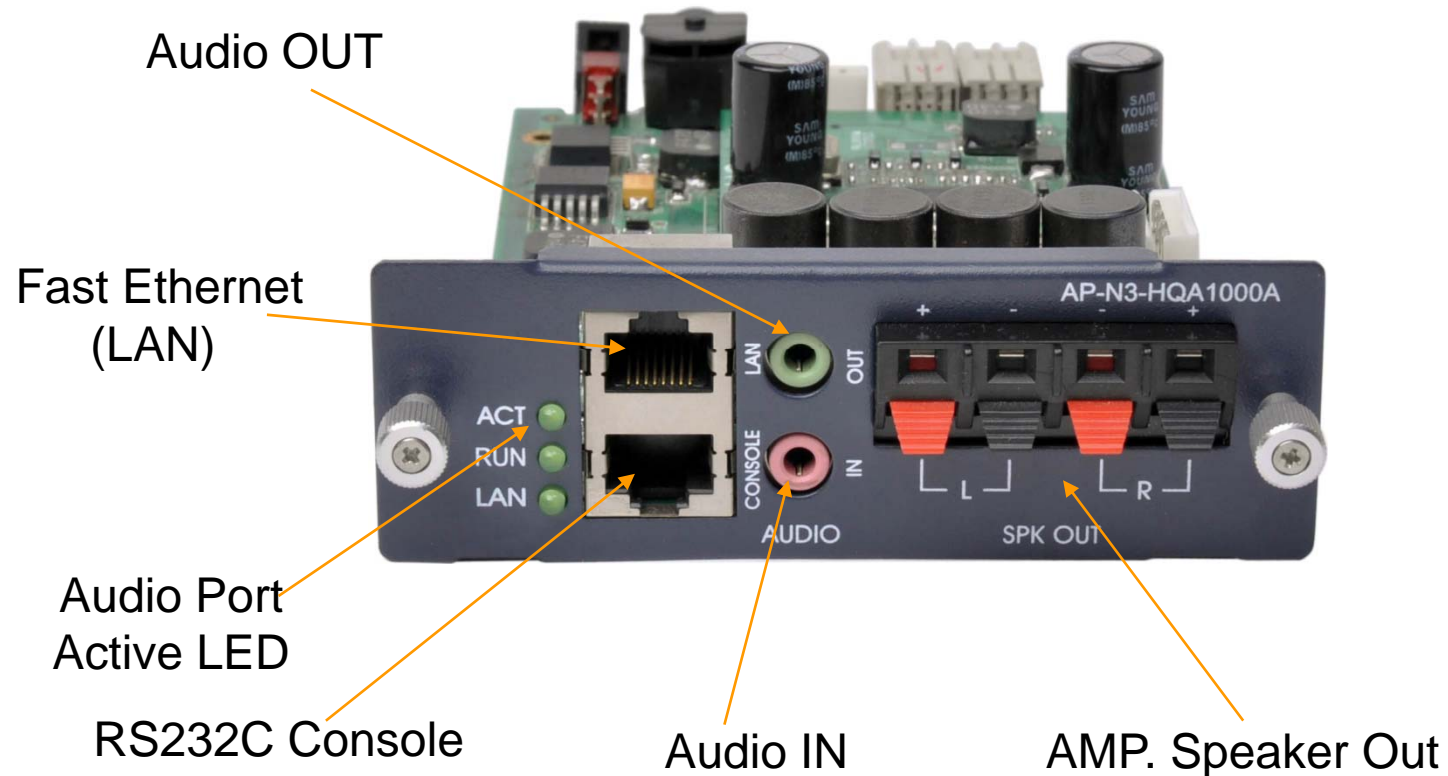

# Hardware Specification

AP1605 IP Audio Broadcasting Terminal

RISC  
CPU

High-end  
DSP

## AP1605 Audio Module

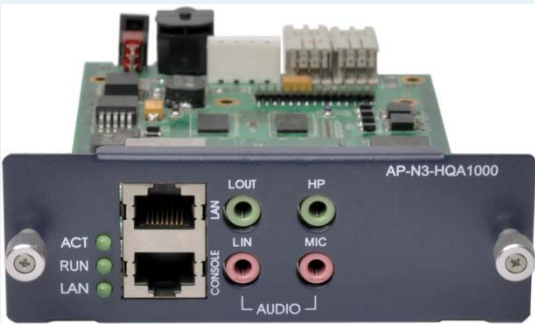
Audio Module Type	Audio Module Features
AP-N1-HQA1000	One(1)-Channel Audio In/Out Port
	One(1) Fast Ethernet Port
	One(1) RS232C Port
	Audio Encoding/Decoding Service
	Audio IN : MIC, Line IN
	Audio OUT : Headphone, Line OUT 3.5mm Stereo JACK
	High Quality Codec, G.711 Audio Codec

# Hardware Specification

AP1605 IP Audio Broadcasting Terminal

RISC  
CPU

High-end  
DSP

## AP1605 Audio Module

Audio Module Type	Audio Module Features
AP-N1-HQA1000A	One(1)-Channel Audio In/Out Port
	One(1) Fast Ethernet Port
	One(1) RS232C Port
	Audio Encoding/Decoding Service
	Audio IN
	Audio OUT
	AMP. Built-in Speaker Out (Left, Right)
	4ohm Speaker : 50Watt
	8ohm Speaker : 30Watt
	High Quality Codec,G.711 Audio Codec



# AP-N3-HQA1000 Module

AP1605 IP Audio Broadcasting Terminal

RISC  
CPU

High-end  
DSP

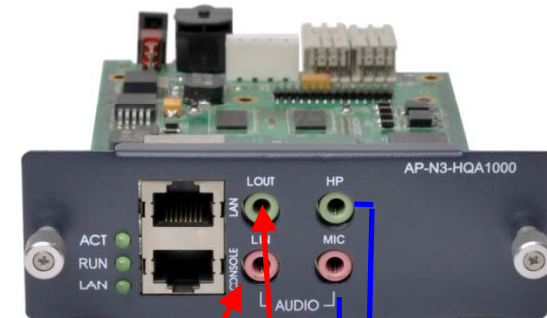

Connect with 1:2 Stereo Jack

Connect with 2:1 Stereo Jack

Direct MIC

- High Quality audio codec realizes high quality audio service
- Direct MIC-In/ Headphone In Port for monitoring
- Real time High Quality Audio Band Broadcasting



Headphone

# APOS™ Service Features

AP1605 IP Audio Broadcasting Terminal

- **APOS Internetworking Software**

- AddPac Operating System (APOS)
- Support Industry Standard
- Integrated Networking Protocols
- Optimized Performance & Functionality
- Easy to use, Installation, and Maintenance

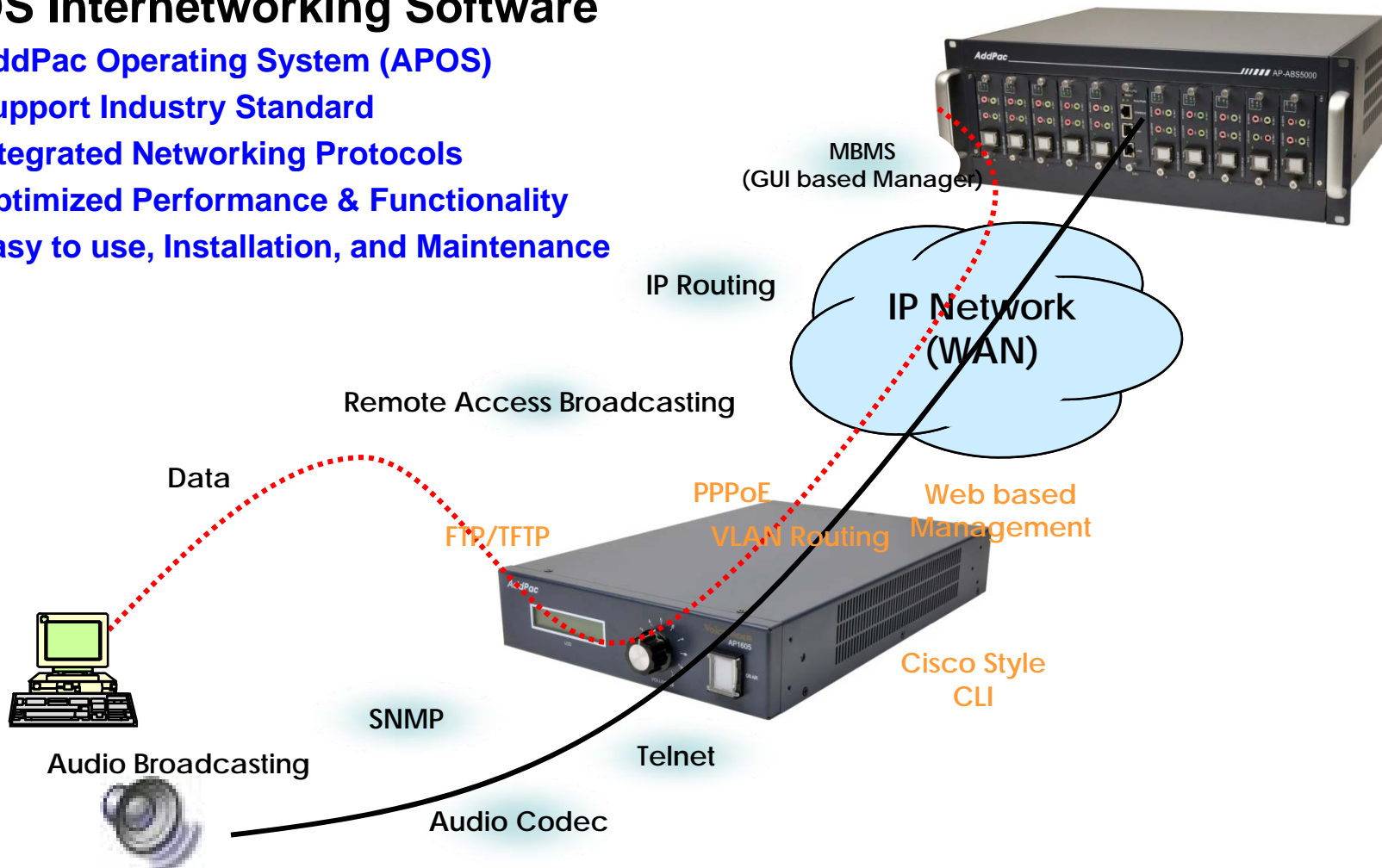

# APOS™ Service Features

AP1605 IP Audio Broadcasting Terminal

- **IP Routing Protocols**

- Multi-protocol Internetworking Services
- Static & Default IP routing

- **WAN Protocols**

- Point-to-Point Protocol (PPPoE for ADSL)
- IEEE 802.3 Ethernet
- PPTP support for secure communication

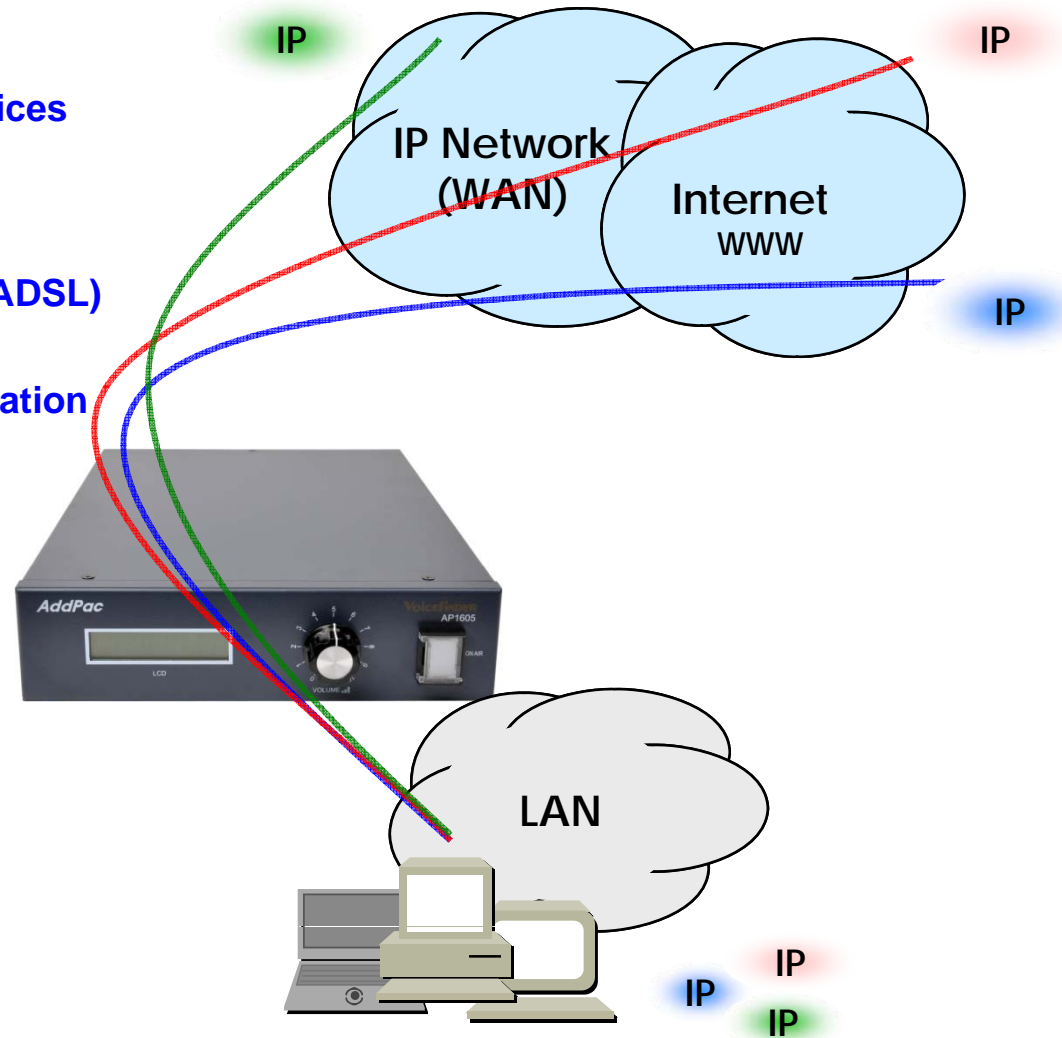

# APOS™ Service Features

## AP1605 IP Audio Broadcasting Terminal

- **Network Managements**
  - Standard SNMP Agent (MIB v2) Support
  - Remote Management using Console, Telnet
  - Web based Management using HTTP Server Interface
- **Security Functions**
  - Standard & Extended IP Access List
  - Enable/Disable for Specific Network Protocols
  - Multi-level User Account Management
  - Auto-disconnect for Telnet/Console Sessions
  - PPP User Authentication Supports (PAP & CHAP)
- **Operation & Managements**
  - System Performance Analysis for Process, CPU, Connection Interface
  - Debugging, System Auditing, and Diagnostics Support
  - System Booting and Auto-rebooting with Watchdog Feature
  - System Managements with Data Logging
  - IP Traffic Statistics with Accounting

# APOS™ Service Features

## AP1605 IP Audio Broadcasting Terminal

- **Network Protocols**

- DHCP Server & Relay Functions
- Network Address Translation (NAT) Function
- Port Address Translation (PAT) Function
- Transparent Bridging (IEEE Standard) Function
  - Spanning Tree Bridging Protocol Support
  - Remote Bridging Support
  - Concurrent Routing and Bridging Support
- Cisco Style Command Line Interface (CLI)
- Network time Protocol (NTP) Support

- **MBMS (Multimedia Broadcast Management System)**

- MS Windows Graphical User Interface (GUI) based Audio Broadcasting Management
- Service Group Configuration
- Scheduled Broadcasting
- Status Monitoring
- Report Service
- Embedded Media file Manager



# APOS™ Service Features

## AP1605 IP Audio Broadcasting Terminal

- Audio Codec for AP-HQA Module

- High Quality Audio Codec
- G.711 Audio Codec

IP Broadcasting

- RTP Protocols

- Redundant RTP packet transmission in case of severe packet loss
- Dynamic jitter buffer management and RPT packet jitter and loss compensation with heuristic & DSP error concealment
- Static jitter buffer setting support
- Voice frame per RTP packet number control for each codec



# IP Audio Broadcasting Signal Flow

## AP1605 IP Audio Broadcasting Terminal

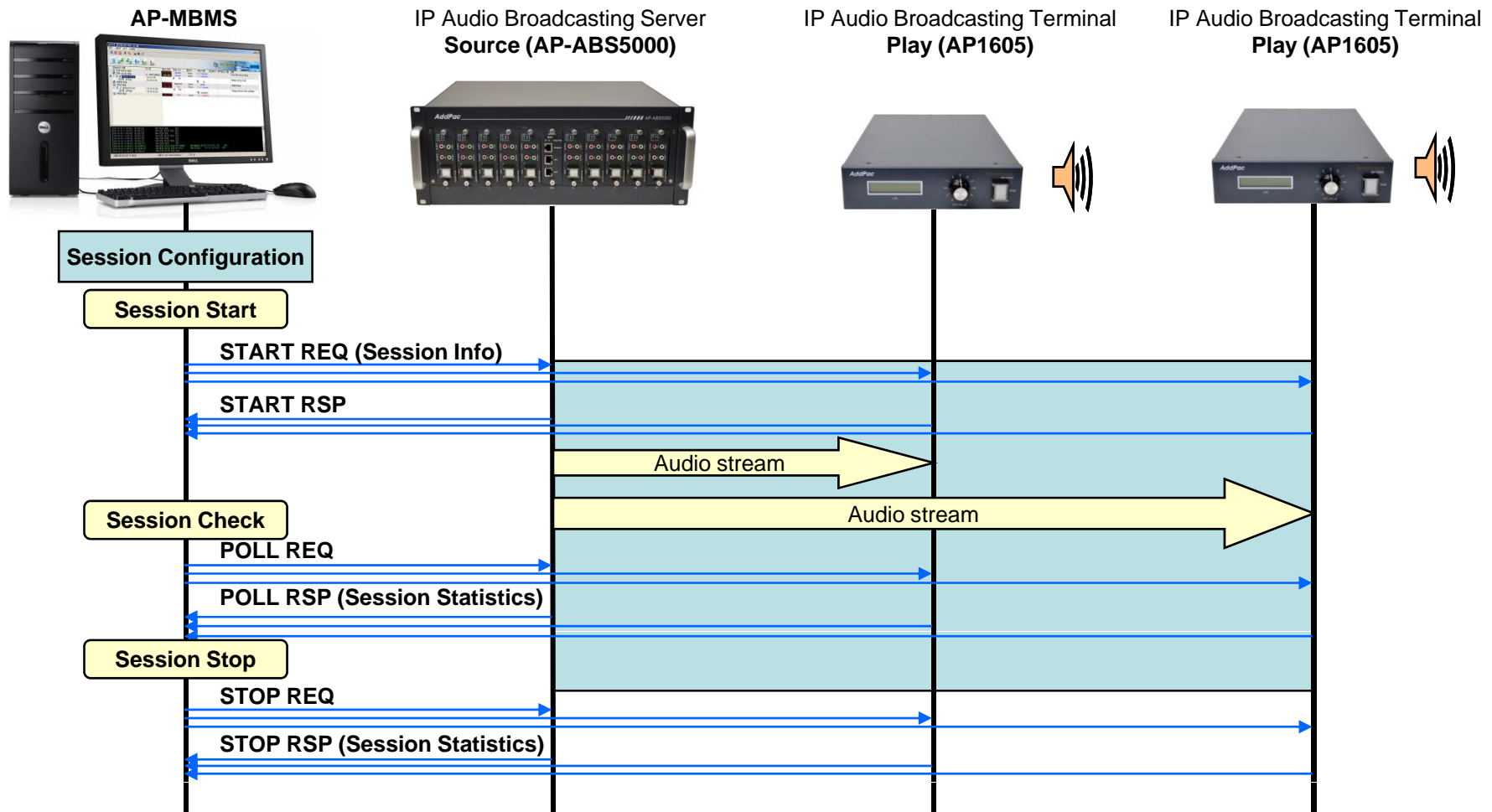

# Multicast Service Network Diagram

AP1605 IP Audio Broadcasting Terminal

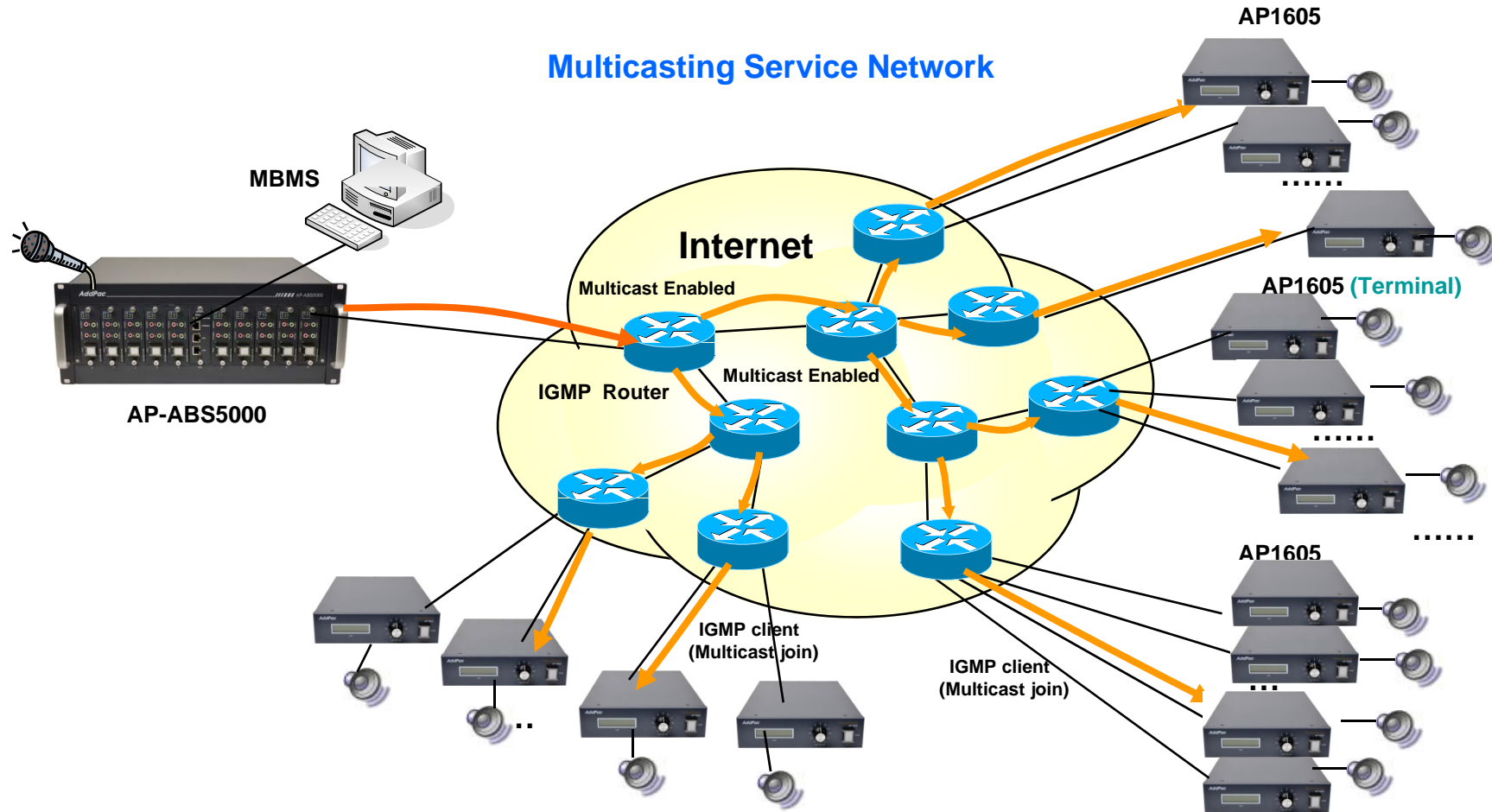

- Multicast protocol based such as **IGMP Protocol**
- Available to broadcast multi destination with single channel bandwidth

# Unicast Service Network Diagram

AP1605 IP Audio Broadcasting Terminal

## Unicasting Service Network

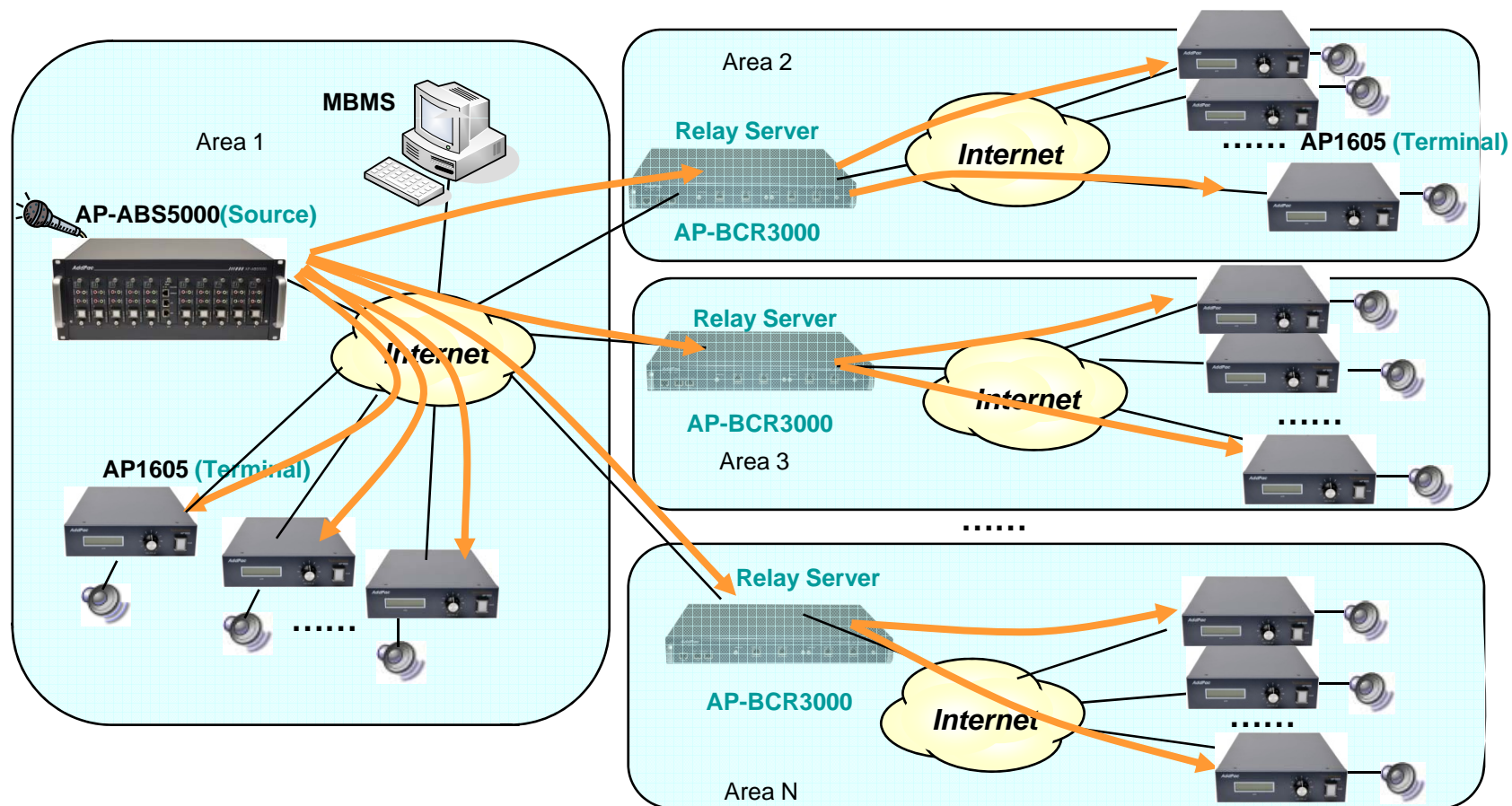

# MBMS 2.0 Software Features

AP1605 IP Audio Broadcasting Terminal

- User Registration Management
- User Access Restriction
- Broadcasting System Management
- Broadcasting Session Management
- Scheduling Broadcasting and On-time Broadcasting
- Emergency Broadcasting Management
- Scheduling Stop Management
- Event Log Management
- MBMS System Redundancy & Auto Data Backup

# MBMS 2.0 Software Features

AP1605 IP Audio Broadcasting Terminal



# MBMS S/W Startup (Example)

## AP1605 IP Audio Broadcasting Terminal

학교 멀티미디어 방송 시스템

관리 사용자 보기 도움말

학교 멀티미디어 방송 시스템 AddPac

방송채널 이름	호스트	방송 상태	방송 소스	릴레이	방송 단말	방송예약	예약방송 이름	설명
전체 비디오 방송		ON-AIR	Normal	None	1 / 1 Normal			학교 전체 비디오 방송
전체 오디오 방송	화재긴급방송	ON-AIR	Normal	None	1 / 1 Normal			
<input checked="" type="checkbox"/> 방송실 오디오 <input checked="" type="checkbox"/> 교무실1	172.16.7.55 172.16.19.101		Ok		Ok			방송실 오디오 서버
운동장 방송		ON-AIR	Unknown	None	None			운동장 방송
1학년 방송		ON-AIR	Fail	None	1 / 1 Normal			
<input checked="" type="checkbox"/> 방송실 비디오 <input checked="" type="checkbox"/> 교무실1	172.16.19.102 172.16.19.101		Fail		NoSESS			방송실 비디오 서버 (AP5840)
2학년 방송		ON-AIR	Fail	None	0 / 1 Normal			

```

[2006-05-09 11:44:46] BC_POLL [5] SNA=1학년 방송 [Ok]
[2006-05-09 11:44:56] BC_POLL [1] SNA=전체 오디오 방송 [Ok]
[2006-05-09 11:45:06] BC_POLL [5] SNA=1학년 방송 [Ok]
[2006-05-09 11:45:16] BC_POLL [1] SNA=전체 오디오 방송 [Ok]
[2006-05-09 11:45:26] BC_POLL [5] SNA=1학년 방송 [Ok]
[2006-05-09 11:45:37] BC_POLL [1] SNA=전체 오디오 방송 [Ok]
[2006-05-09 11:45:46] BC_POLL [5] SNA=1학년 방송 [Ok]
[2006-05-09 11:45:51] BC_START [1] SNA=전체 오디오 방송 NTY=SOURCE ENA=방송실 오디오 IP=172.16.7.55 [Ok]
[2006-05-09 11:45:51] BC_START [1] SNA=전체 오디오 방송 NTY=PLAY ENA=교무실1 IP=172.16.19.101 [Ok]
[2006-05-09 11:45:56] BC_POLL [1] SNA=전체 오디오 방송 [Ok]
    
```

2006-05-09 오전 11:46:01 사용자: root (administrator) 1,0,0,14

# Broadcasting Equipment Management (Example)

AP1605 IP Audio Broadcasting Terminal

학교 멀티미디어 방송 시스템

관리 사용자 보기 도움말

방송 장비 관리

방송장비 이름 (방송 이름)	호스트 주소 (ON...	장비 모델명	입력포트	출력 포트	설명	포트 이름
과학실	1.1.1.1	AP1601				
교무실1	172.16.19.101	AP2520				
1학년 방송			1-1	1-1		
2학년 방송			0-1	0-1		
전체 오디오 방송			1-1	1-1		
미술실	1.1.1.2	AP2120				
방송실 비디오	172.16.19.102	AP5840			방송실 비디오...	
1학년 방송			2-1	2-0		
2학년 방송			1-1	1-0		
전체 비디오 방송			1-1	1-0	학교 전체 비...	
방송실 오디오	172.16.7.55	AP3150			방송실 오디오...	
전체 오디오 방송			7-1	7-1		
비디오 단말	172.16.39.24	AP-VP300			vp200 단말	
전체 비디오 방송			0-1	0-0	학교 전체 비...	

Total : 6 Selected count : 1

2006-05-09 12:00:32 ModifyEquipment [6] ENA=미술실 [Ok]  
 2006-05-09 12:00:36 BC\_POLL [1] SNA=전체 오디오 방송 [Ok]

2006-05-09 오후 12:00:43 사용자: root (administrator) 1.0.0.14



# Broadcasting Configuration (Example)

AP1605 IP Audio Broadcasting Terminal

학교 멀티미디어 방송 시스템

관리 사용자 보기 도움말

학교 멀티미디어 방송 시스템 AddPac

방송선 구성

방송선 이름: 전체 오디오 방송

방송 장비 이름	IP 주소
방송실 오디오	172.16.7.55
교무실1	172.16.19.101

방송 장비 이름	IP 주소	설명	포트 설명
과학실	1,1,1,1		
AP-AUDIO2	( 0/1, 0/1 )		
AP-AUDIO2	( 0/0, 0/0 )		
교무실1	172.16.19.101		
AP-AUDIO2	( 1/0, 1/0 )		
AP-AUDIO2	( 1/1, 1/1 )		
AP-AUDIO2	( 0/1, 0/1 )		
AP-AUDIO2	( 0/0, 0/0 )		
미술실	1,1,1,2		
AP-AUDIO2	( 1/1, 1/1 )		
AP-AUDIO2	( 1/0, 1/0 )		
방송실 비디오	172.16.19.102	방송실 비디...	
AP-AV1000	( 2/1, 2/0 )		
AP-AV1000	( 1/1, 1/0 )		
방송실 오디오	172.16.7.55	방송실 오디오...	
AP-AUDIO2	( 7/1, 7/1 )		
AP-AUDIO2	( 7/0, 7/0 )		
AP-AUDIO2	( 6/1, 6/1 )		
AP-AUDIO2	( 6/0, 6/0 )		
AP-AUDIO2	( 5/1, 5/1 )		

방송소스

방송단말

삭제

선택

Total : 6

2006-05-09 오후 12:18:22 사용자: root (administrator) 1,0,0,14

# Broadcasting Scheduling (Example)

AP1605 IP Audio Broadcasting Terminal

방송세션 이름	예약 방송 이름	예약 방송 종류	요일	시작 시간	종료 시간	설명
전체 오디오 방송	2교시 종료	월요일-금요일		10:50:00	10:50:15	
전체 오디오 방송	2교시 시작	월요일-금요일		10:00:00	10:00:15	
전체 오디오 방송	1교시 종료	월요일-금요일		09:50:00	09:50:15	
전체 오디오 방송	1교시 시작	월요일-금요일		09:00:00	09:00:15	
전체 오디오 방송	점심 방송	월요일-금요일		12:00:00	13:00:00	
전체 오디오 방송	아침 방송	월요일-금요일		07:30:00	08:30:00	
전체 오디오 방송	3교시 종료	월요일-금요일		11:50:00	11:50:15	
전체 오디오 방송	3교시 시작	월요일-금요일		11:00:00	11:00:15	

# Event Log (Example)

AP1605 IP Audio Broadcasting Terminal

**이벤트 이력 조회**

일자&시간: 2006-05-08 오후 12:16:21 ~ 2006-05-09 오후 12:16:21

일자&시간	이벤트	동작	방송종류	방송이름	장비종류	장비이름	IP주소	장비상태	예약방송이름
2006-05-08 14:43:33	Request	STOP	UNICAST	테스트 오디오 방송					
2006-05-08 14:43:05	Request	START	UNICAST	테스트 오디오 방송					
2006-05-08 14:43:03	Request	START	UNICAST	테스트 오디오 방송					
2006-05-08 14:42:56	Request	STOP	UNICAST	테스트 오디오 방송					
2006-05-08 14:42:49	Request	START	UNICAST	테스트 오디오 방송					
2006-05-08 14:42:48	Request	START	UNICAST	테스트 오디오 방송					
2006-05-08 14:42:48	Request	START	UNICAST	테스트 오디오 방송					
2006-05-08 14:42:48	Request	START	UNICAST	테스트 오디오 방송					
2006-05-08 14:42:47	Request	STOP	UNICAST	테스트 오디오 방송					
2006-05-08 14:42:46	Request	START	UNICAST	테스트 오디오 방송					
2006-05-08 14:42:46	Request	STOP	UNICAST	테스트 오디오 방송					
2006-05-08 14:07:19	Request	START	UNICAST	테스트 비디오 방송					
2006-05-08 14:07:17	Response	STOP	UNICAST	테스트 오디오 방송	PLAY	교실	172.16.19.1...	Not Response	
2006-05-08 14:07:17	Response	STOP	UNICAST	테스트 오디오 방송	SOURCE	방송실	172.16.7.55	Not Response	
2006-05-08 14:07:16	Request	STOP	UNICAST	테스트 오디오 방송					
2006-05-08 14:07:07	Response	START	UNICAST	테스트 오디오 방송	PLAY	교실	172.16.19.1...	Not Response	
2006-05-08 14:07:07	Response	START	UNICAST	테스트 오디오 방송	SOURCE	방송실	172.16.7.55	Not Response	
2006-05-08 14:07:06	Request	START	UNICAST	테스트 오디오 방송					
2006-05-08 14:05:09	Request	STOP	UNICAST	테스트 비디오 방송					
2006-05-08 13:57:05	Request	START	UNICAST	테스트 비디오 방송					

2006-05-09 12:16:57] BC\_POLL [1] SNA=전체 오디오 방송 [Ok]

2006-05-09 오후 12:16:56 사용자: root (administrator) 1,0,0,14

# IP HQ Audio Broadcasting Solution

Audio Broadcasting Manager S/W	HQ Audio Broadcasting Server AP-ABS5000	Audio Broadcasting Router (Relay Server)	HQ Audio Broadcasting Terminal AP1605A
			
<p>Window based Audio Broadcasting Management Software.</p>	<p>Embedded Hardware based Audio Codec. Ten(10) HQ Audio Codec Module. High Quality Codec,G.711 Audio Codec.</p>	<p>1:N Audio Broadcasting Router. Gigabit Ethernet Support</p>	<p>Embedded Hardware based Audio Terminal. <b>Volume Control Rotary Switch.</b> One(1) HQ Audio Codec Module. <b>Built-in AMP.</b> High Quality Codec,G.711 Audio Codec.</p>

# Application Service (IP Broadcasting Service)

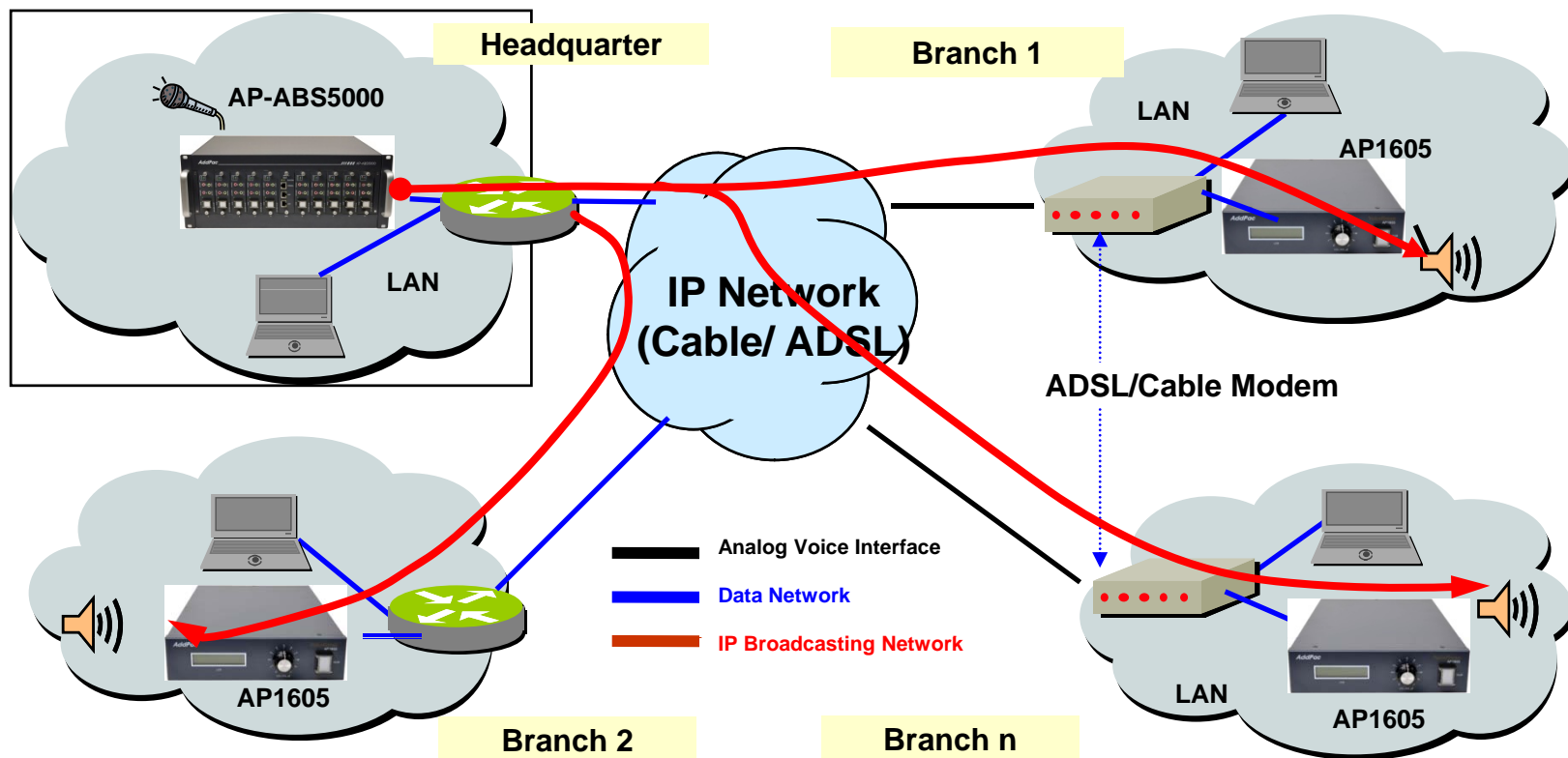

# Ordering Information

- **AP1605 IP Audio Broadcasting Terminal Hardware**
  - AP1605 Main Body
  - RISC Microprocessor with High-end Programmable DSP Architecture
  - Option : AP-N3-HQA1000 Module , AP-N3-HQA1000A Module
  - Including Network Cable Set & Power Supply, etc.
- **Built-in APOS Internetworking Software for AP1605**
- **Including 1 Year Hardware Warranty**
- **Product Documents**
  - Install and Operation Guide (PDF)
- **Pricing**
  - AddPac Technology Regional Sales Manager
  - Authorized Sales and Marketing Representatives
  - Please Contact [www.addpac.com](http://www.addpac.com)



# Thank you!

**AddPac Technology Co., Ltd.**  
Sales and Marketing

Phone +82.2.568.3848 (KOREA)

FAX +82.2.568.3847 (KOREA)

E-mail [sales@addpac.com](mailto:sales@addpac.com)