

AP6800™

Large Scale VoIP Gateway

High Performance Fault Tolerant Large-Scale VoIP Gateway Solution

Product Overview



AddPac

AddPac Technology

2006, Sales and Marketing

www.addpac.com

Contents

AP6800 Large Scale VoIP Gateway

- Product Overview
- Hardware Specification
- APOS Technology
- VoIP (Voice over IP) service
- Advanced QoS Features
- Network Protocols
- Network Management
- Security Management
- Application Service
- Ordering Information



Product Overview

AP6800 Large Scale VoIP Gateway

- CPU Board Duplication (Active/Standby CPU Board)
- Scalable Architecture (32-Port FXS, FXO Subscriber Boards)
- Hardware Board Hot-Swap Function
- Up to 256 Port VoIP Gateway Service
- SIP/MGCP Fault Tolerant Concurrent Stack (Dual CPU Mode),
- High Performance RISC & Programmable DSP Architecture
- Two(2) 10/100/1000Mbps Giga Bit Ethernet (CPU Board)
- G.711/G.726/G.723/G.729, T.38 Fax , VAD, etc
- Powerful Network Protocols (PPPoE, DHCP, Static Routing, etc)
- Firmware Upgradeable Architecture
- Advanced Voice QoS Mechanism
- Dual Power Supply Module, Power Redundancy (AC Input, DC48)

Product Highlights

AP6800 Large Scale VoIP Gateway

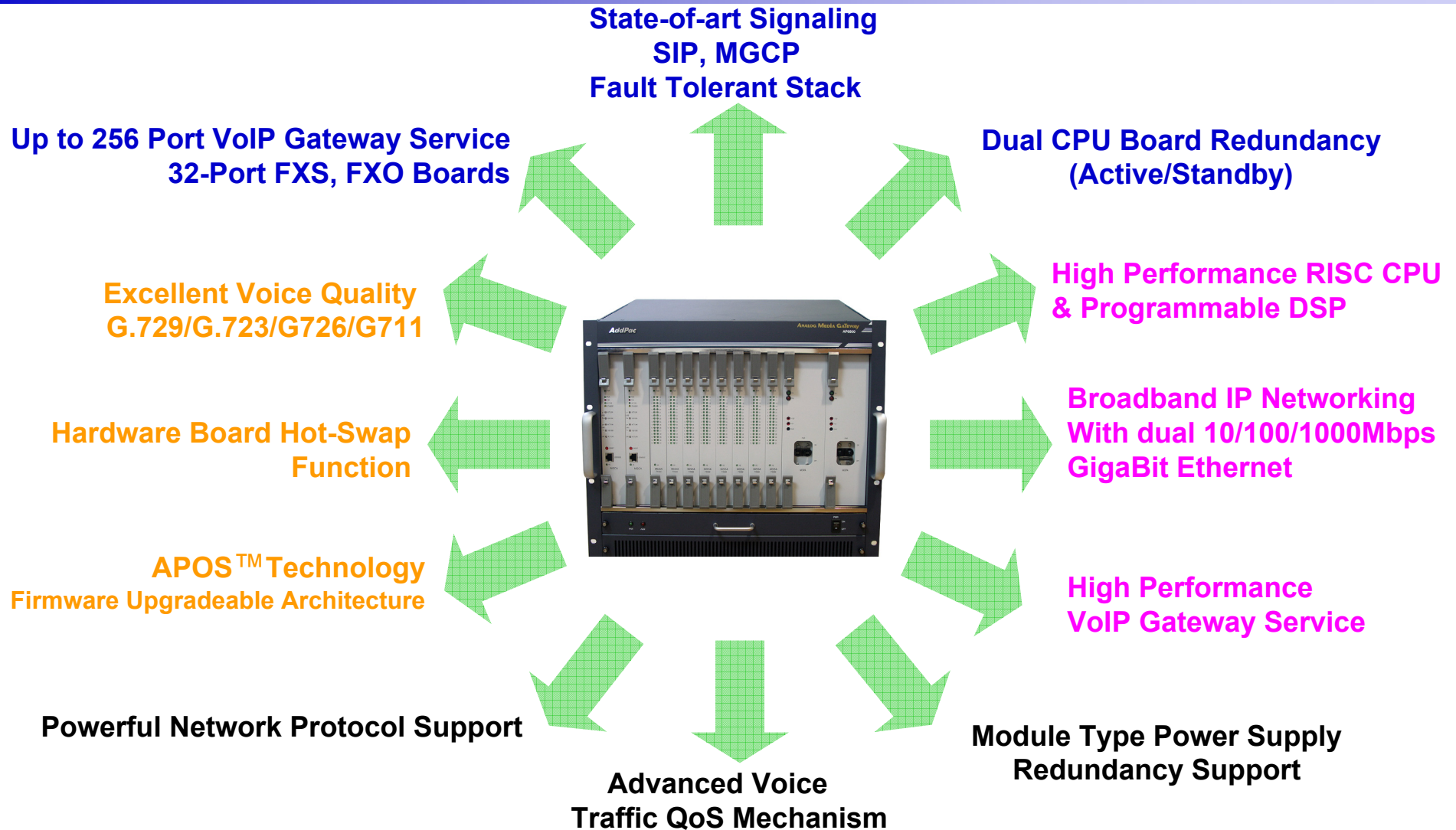

AddPac

www.addpac.com

APOS Technology

AP6800 Large Scale VoIP Gateway



- APOS : AddPac Internetworking Operating System
- OSD : On- Screen Display
- EMS : Element Management System

Hardware Specification

AP6800 Large Scale VoIP Gateway

RISC
CPU

High-end
DSP

- **RISC Microprocessor Computing Power + High End Programmable DSP**
- **Active/Standby Dual CPU Boards**
- **Up to 256 VoIP Port**
 - 32 Port FXS Module
 - 32 Port FXO Module
- **Network Interface**
 - Two(2) 10/100/1000Mbps Giga Ethernet (RJ45)
- **Power Supply**
 - Module Type Dual Power Supply
 - DC48V, AC110~220V Selectable at Ordering
- **Power LED, LAN LED, FXS Port LED**

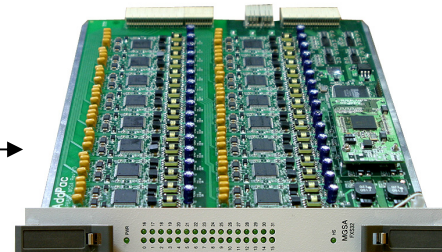
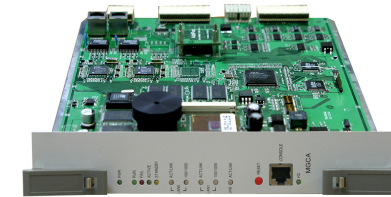

Hardware Specification

AP6800 Large Scale VoIP Gateway

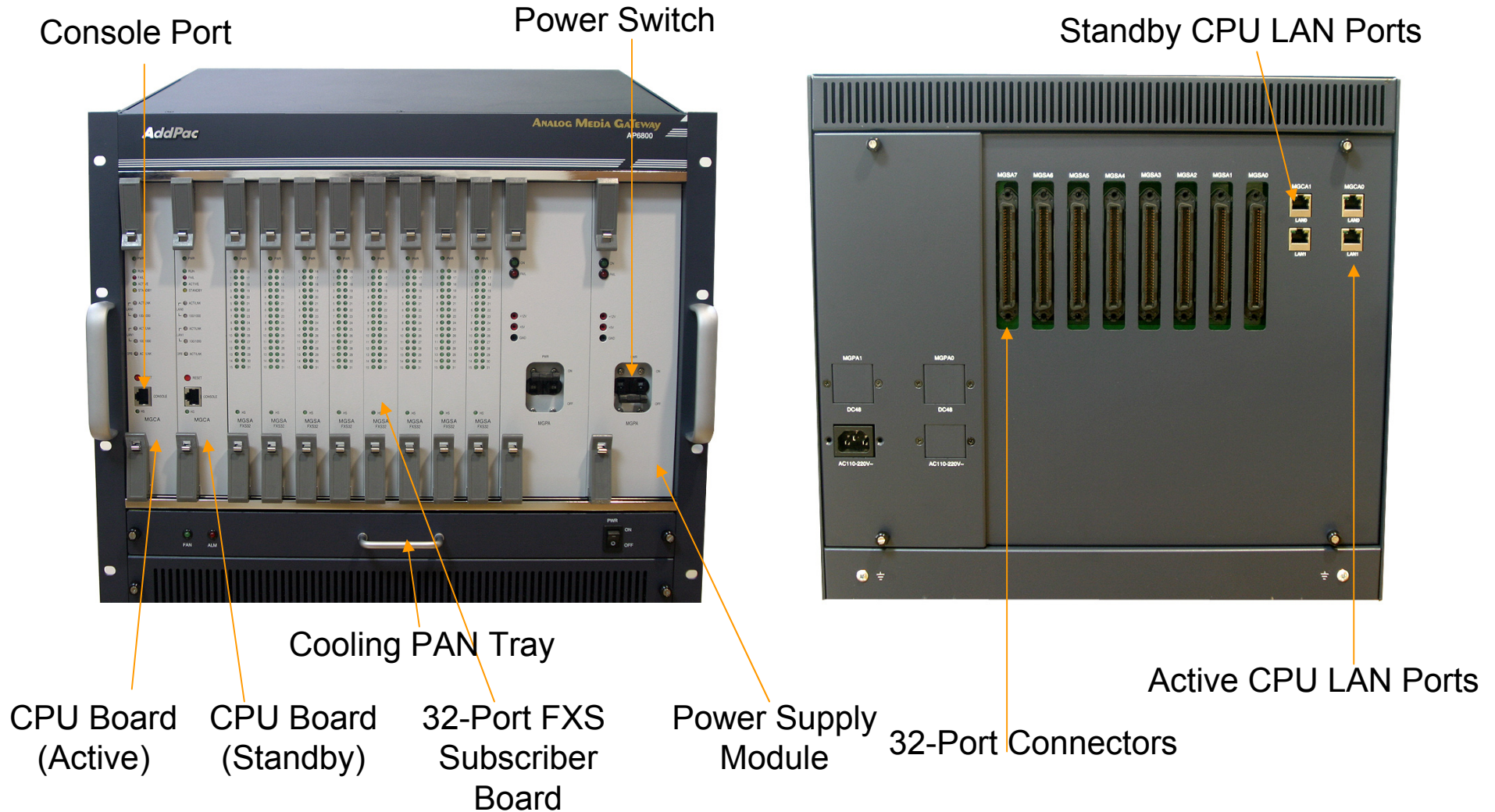

Hardware Specification

AP6800 Large Scale VoIP Gateway

AP-MGSA FXS Subscriber Assembly Board Features

- **NGN Subscriber FXS Board Features**
- **Powerful 80Vrms Ring Swing**
- **Long Distance Analog Line Interface Support Similar to PSTN Switch**
- **Robust Surge Protection**
- **Hot-Swap Function Support using eject switch**
- **FXS Port Activity Indication LED at Front Panel**
- **Advanced Voice Codec Support**

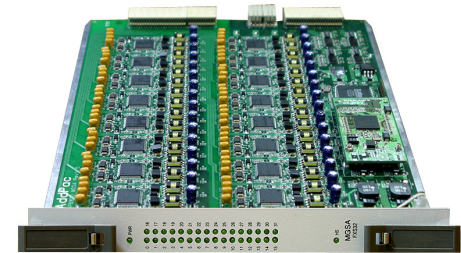

VoIP (Voice over IP) Service

AP6800 Large Scale VoIP Gateway

- SIP, and MGCP Fault Tolerant VoIP Signaling Stack
- SIP
 - IETF RFC3261 or RFC2543 SIP Standard
- MGCP
 - IETF RFC2705bis-02 Standard MGCP 1.0

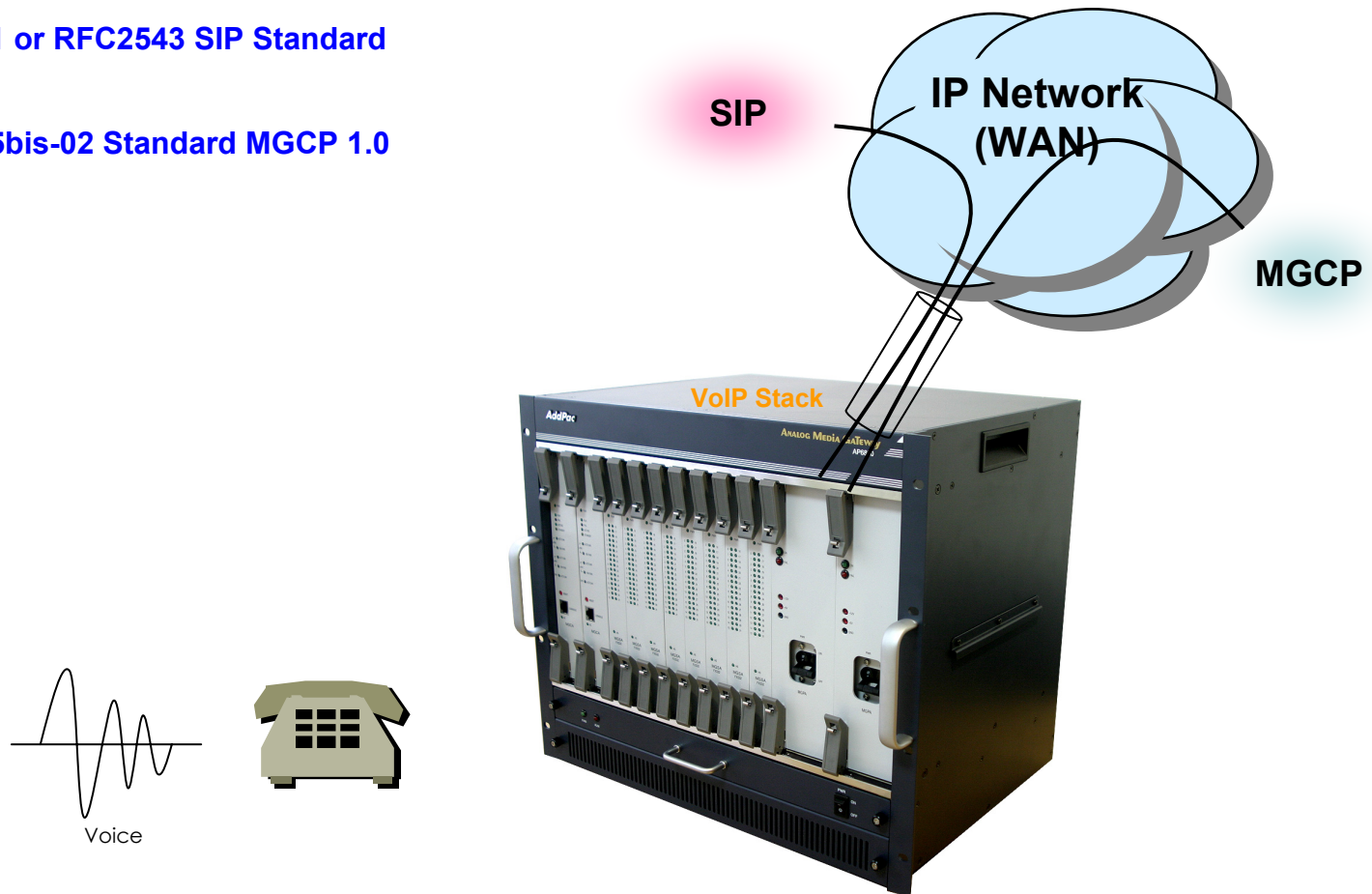

VoIP (Voice over IP) Service

AP6800 Large Scale VoIP Gateway

- **SIP**
 - Gateway-based / Endpoint-based registration support
 - Secondary proxy-server assignment function
 - SIP signaling port change function
 - SIP proxy server assignment according to the domain name
 - T.38 real-time fax relay support
 - DTMF relay support with RFC2833 / OPTION message
 - Re-INVITE support
- **MGCP**
 - Secondary call agent assignment function
 - Default package assignment
 - Announcement Server Package, Generic Media Package, Handset Package, Line Package, Trunk Package support
 - MGCP call agent assignment according to the domain name
 - T.38 real-time fax relay support
 - DTMF relay support based on RFC2833



VoIP (Voice over IP) Service

AP6800 Large Scale VoIP Gateway

- **Voice Codec**

- G.711 A-Law, G.711 U-Law
- G.726 r16, G.726 r32
- G.729A
- G.723.1 r63, G.723.1 r53
- VAD (Voice Activity Detection) function support
- DTMF relay support (H.323, SIP, MGCP common) based on RFC2833

- **RTP**

- Redundant RTP packet transmission in case of severe packet loss
- Dynamic jitter buffer management and RPT packet jitter and loss compensation with heuristic & DSP error concealment
- Static jitter buffer setting support
- Voice frame per RTP packet number control for each codec
- In-band ring-back tone support
- Virtual ring-back tone support
- Tone parameter change support

- **FAX**

- Fax relay mode supporting T.38, inband-T.38, bypass mode
- Lost packet compensation with redundant setting in case of T.38 fax relay
- Fax relay mode, rate setting for remote end

VoIP

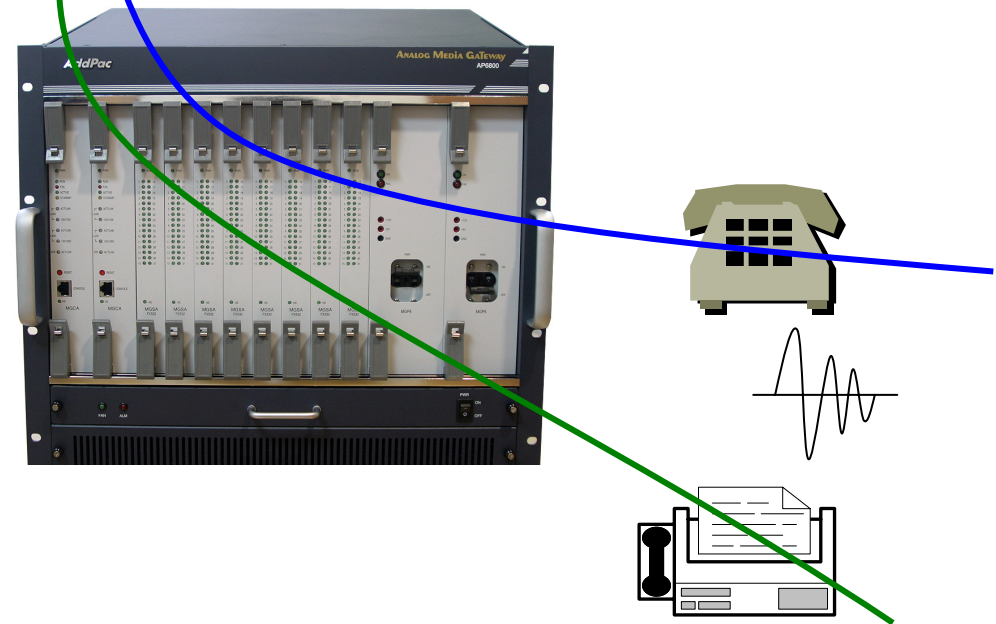

VoIP (Voice over IP) Service

AP6800 Large Scale VoIP Gateway

• VoIP Call Controls

- Hot line connection function with PLAR (Private Line Auto Ring Down)
- Leased line emulation function
- Connection monitoring function
- Fault tolerant with Redundancy and Call Distribution among Gateways for load balancing
- Call attempt with IP address
- SIP, MGCP inbound call connection for each voice port
- Multiple E.164 setting for one voice port
- One E.164 or digit pattern can be assigned to more than one voice port
- Hunting with Longest match/ priority/ sequence/ random
- One stage call setup by Digit forwarding
- Call barring with specific digit patterns
- Calling and called number conversion for PSTN outbound calls
- PSTN rerouting in case of VoIP call attempt failure

• VoIP Call Controls (cont.)

- Call transfer for internal calls
- Call pickup for internal calls
- Calling and called number conversion for VoIP outbound calls
- Calling and called number conversion for VoIP inbound calls
- Fax broadcasting call control

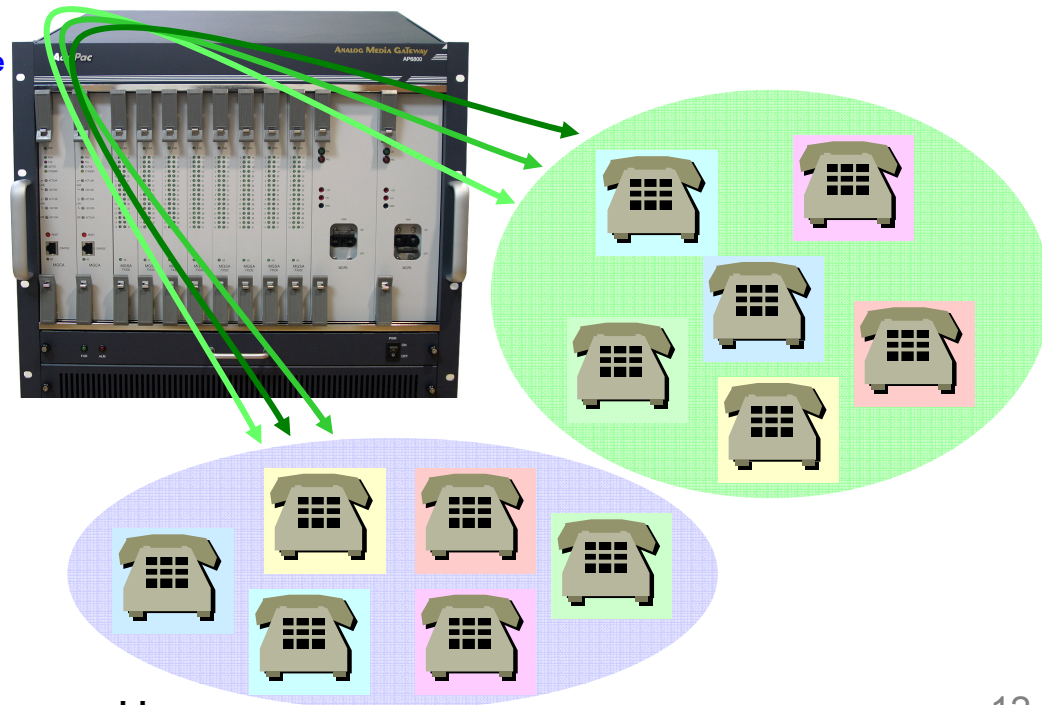

Advanced QoS Features

AP6800 Large Scale VoIP Gateway

- Enhances **Transmit** Voice QoS Features
 - Voice Traffic Priority Queuing
 - QoS Service Profiling
 - Providing Virtual Network Transmit Algorithm
 - Real-time Voice Traffic QoS Support
 - RTP Packet Transmit Interval Control
 - Supporting RTP Packet Redundancy Scheme
 - IP Header Control such as ToS, Diffserv
- Enhances **Receive** Voice QoS Features
 - Dynamic Jitter Buffer Management
 - Error Concealment
 - Support T.38 FAX Data Error Recovery Scheme

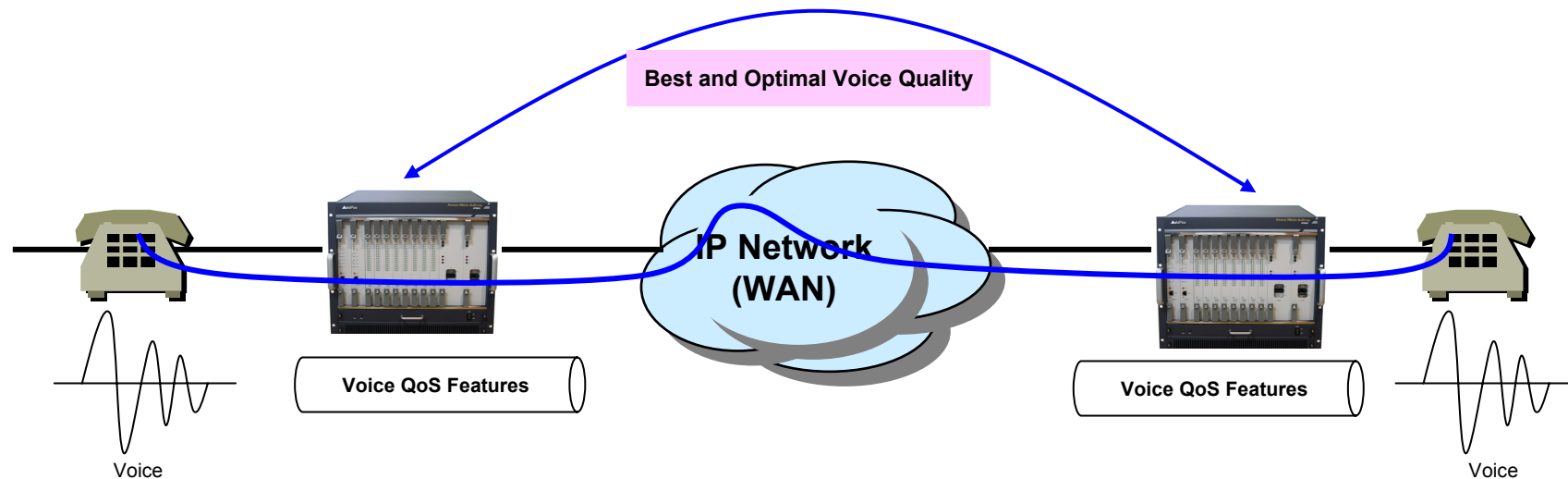

Network Protocols

AP6800 Large Scale VoIP Gateway

Basic Network Protocols

- ARP, IPv4, TCP, UDP, ICMP, SCTP, IGMP, MLD

Routing Protocol

- IPv4 : Static

Service Protocol

- FTP, Telnet, TFTP, DHCP Server/Relay, SNMP Server
- CDP (Cisco Discovery Protocol)
- DNS Resolver , DDNS(nsupdate)
- Bridge
- Syslog

IPv4 Address Configuration

- Fixed (Static)
- DHCP
- PPPoE

Miscellaneous

- Cisco Style CLI
- Standard & Extended IPv4 Access List
- Multi-level User Account Management
- IP accounting
- STUN Client

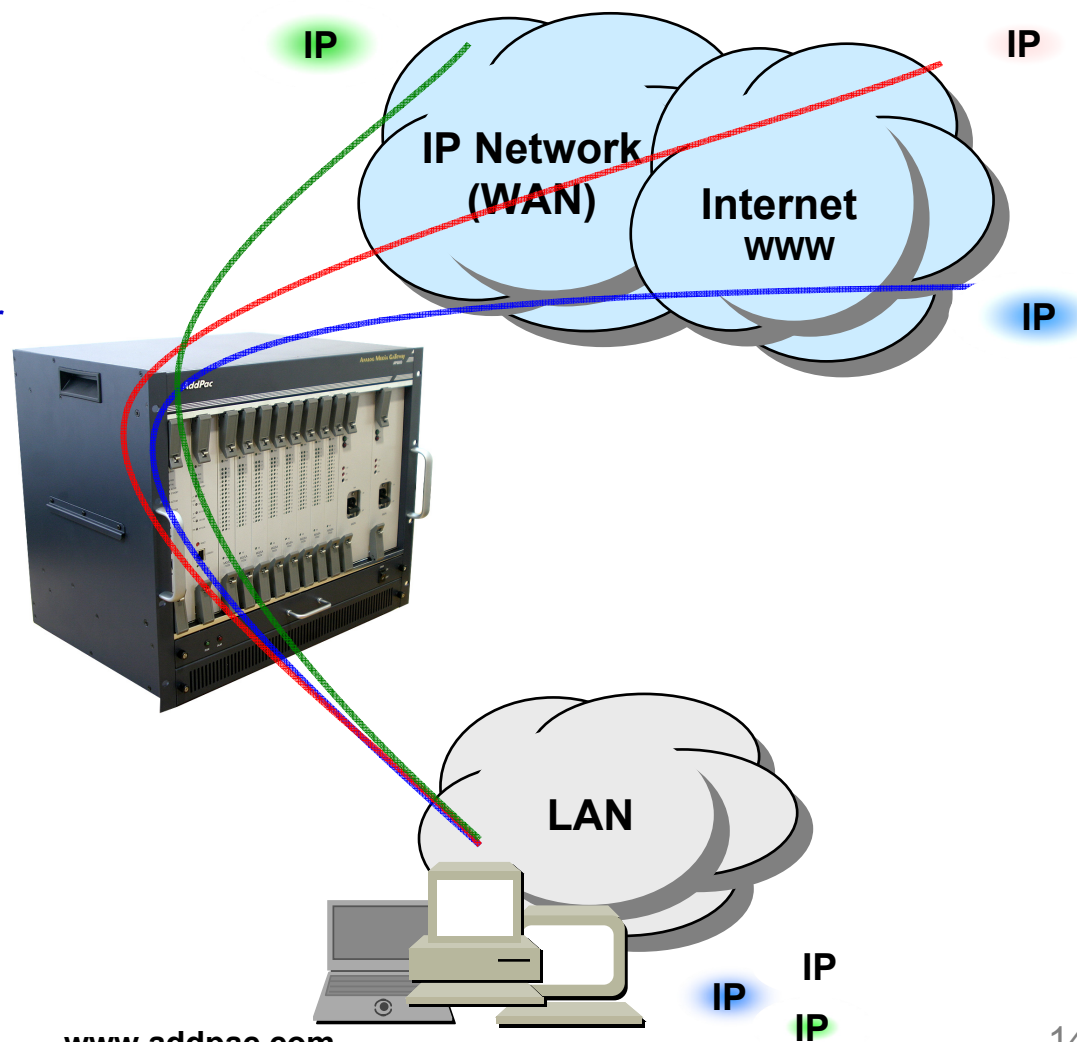

Network Management

AP6800 Large Scale VoIP Gateway

- **SNMP**
 - Standard Simple Network Management Protocol(SNMP) Agent support
 - MIB v1 and v2 Support
- **Watch-dog Function**
 - Hardware, Software watch-dog services
- **Remote Management**
 - Telnet
 - Rlogin
- **Auto Upgrade Service**
 - HTTP server based APOS image and configuration file auto-upgrade support
- **Batch Job Function**
 - Text based script downloading

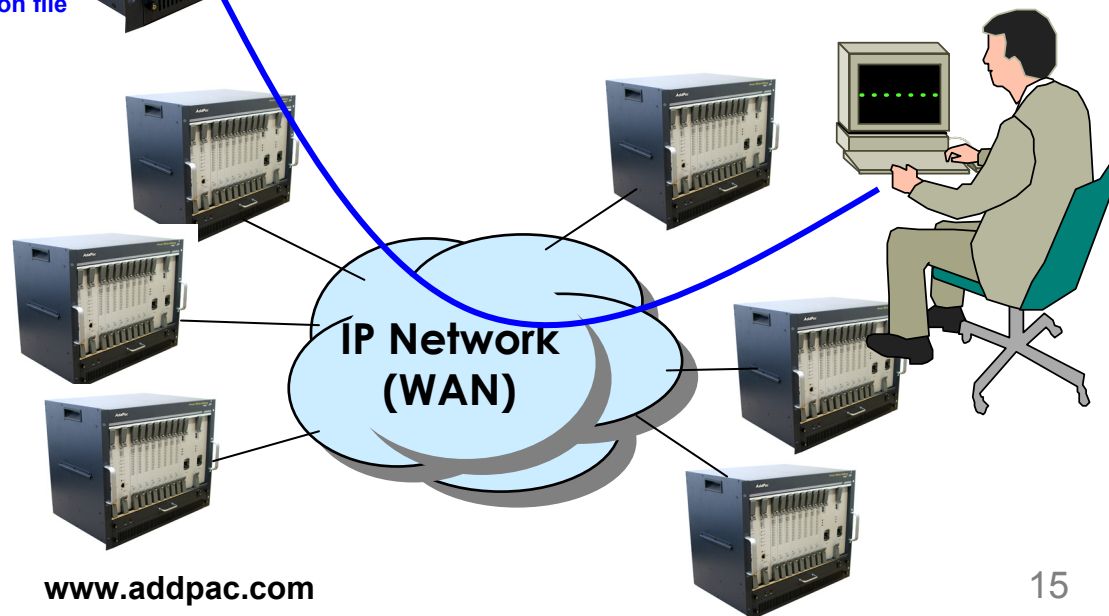
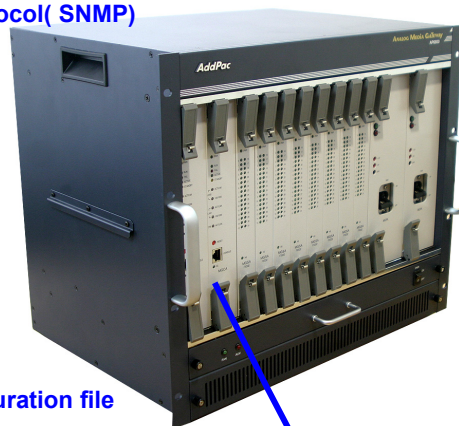

Security Management

AP6800 Large Scale VoIP Gateway

- IP packet filtering
- IP access list
- User authentication function
 - Password Authentication Protocol (PAP)
 - Challenge Handshake Authentication Protocol (CHAP)
- Enable/Disable specific protocols
- Auto-square connect of Telnet session
- Account Management function for multi-level user
- SNMP/TELNET/FTP/HTTP/TFTP port assignment function
- SNMP/TELNET/FTP access list management
- Boot mode security checking function

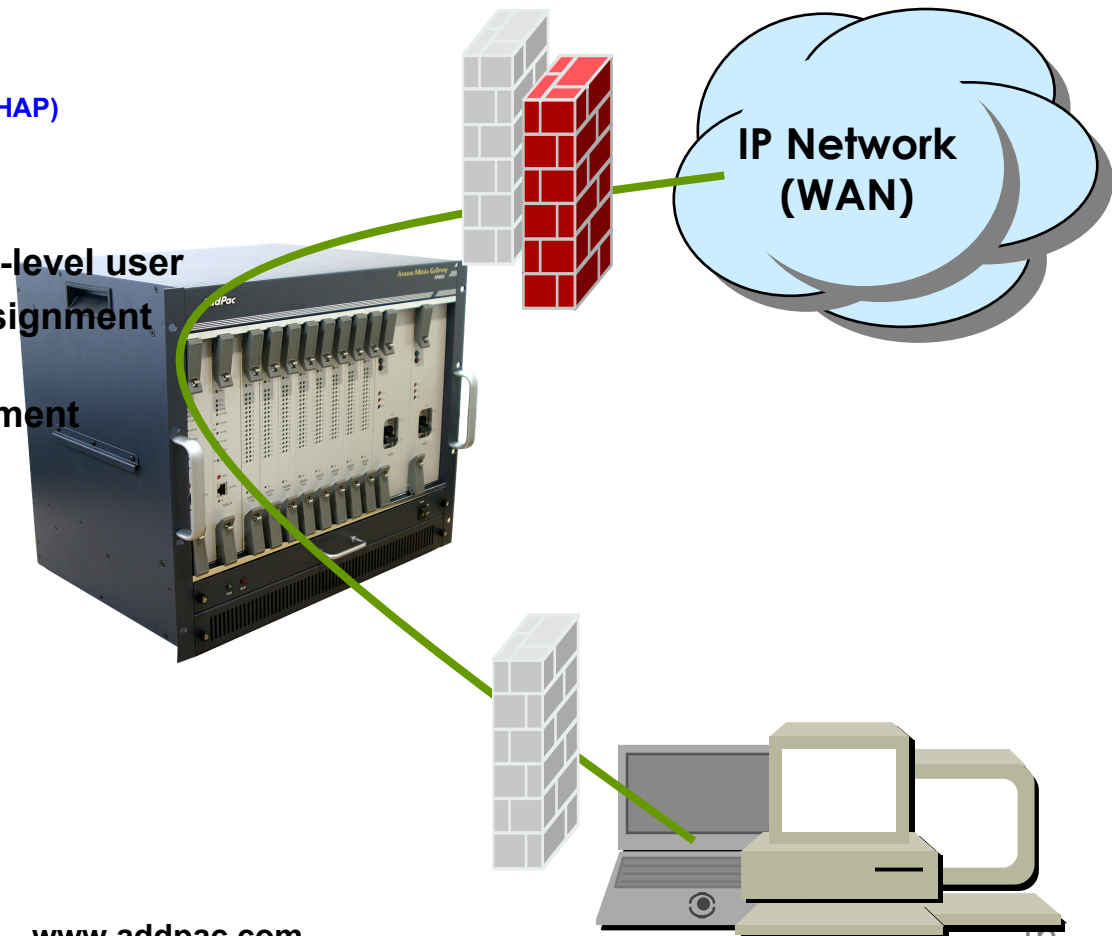

Standard Application

AP6800 Large Scale VoIP Gateway

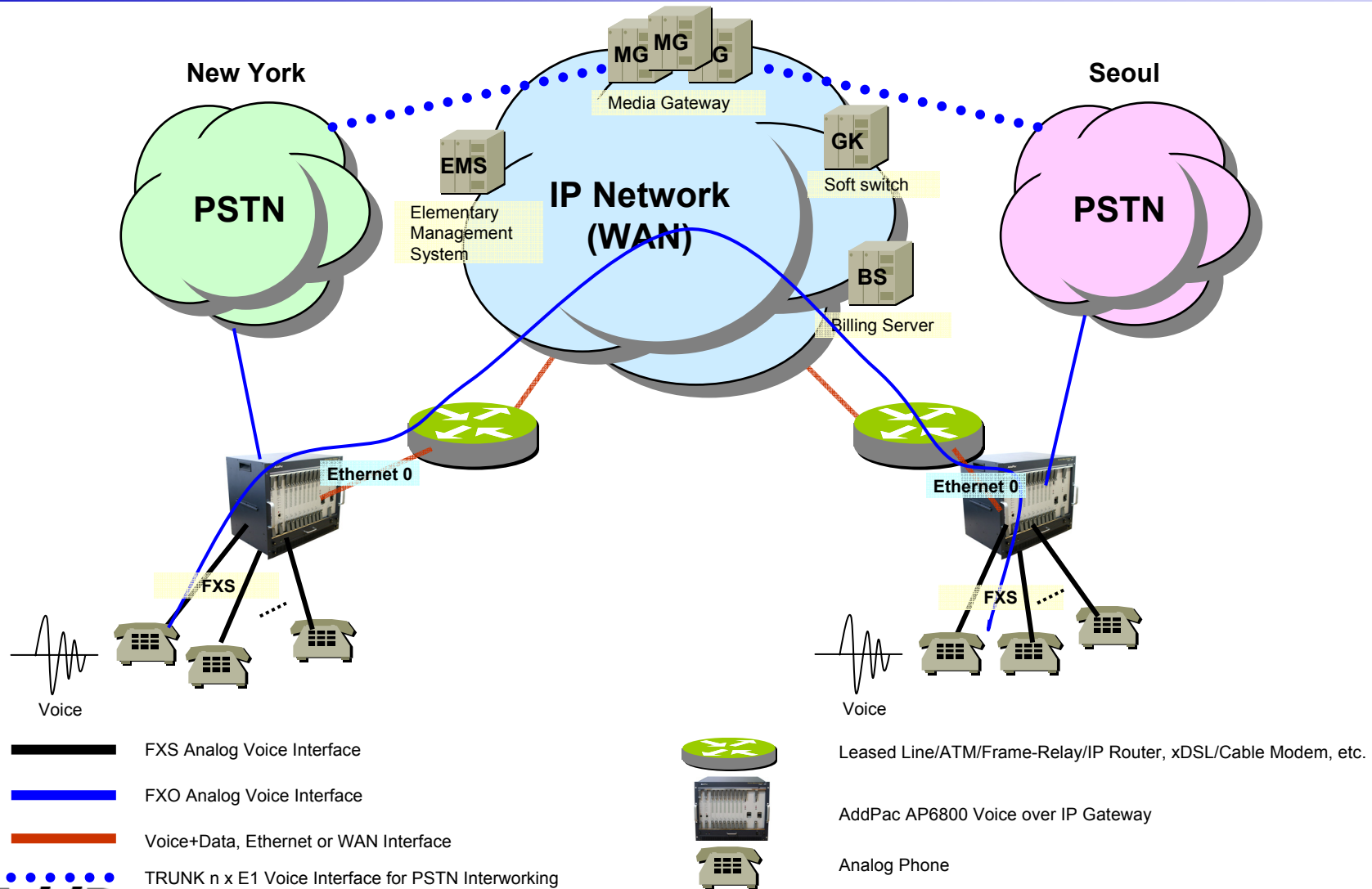

Ordering Information

- **AP6800 VoIP Gateway Hardware**
 - AP6800 VoIP Gateway Main Body
 - Dual CPU Boards (Active/Standby)
2-ports 10/100/1000Mbps Gigabit Ethernet(RJ45), 1-port RS232C Interface for Console (RJ45)
 - 32Port Subscriber Board x N (ordering)
 - Dual Power Supply Module (DC48V or AC Input)
 - Including Network Cable & Ext. Power Supply Cable, etc.
- **Built-in APOS Internetworking Software for AP6800**
- **Including 1 Year Hardware Warranty**
- **Product Documents**
 - Install and Operation Guide (PDF)
- **Pricing**
 - AddPac Technology Regional Sales Manager
 - Authorized Sales and Marketing Representatives
 - Please Contact www.addpac.com

VoIP Gateway Series

Thank you!

AddPac Technology Co., Ltd.
Sales and Marketing

Phone +82.2.568.3848 (KOREA)

FAX +82.2.568.3847 (KOREA)

E-mail sales@addpac.com