

IP Telephony Solution for Medium Size Enterprise



AddPac

AddPac Technology

2012, Sales and Marketing

Contents

- IP Telephony Network Diagram
- IP Telephony Solution Components (Example)
 - IPNext600 Call Manager
 - AP1800 VoIP Gateway for Digital E1 Interface
 - IP Phone (AP-IP230, AP-IP90)
 - AP-VAC50 IP Video Door Phone
 - AP-ACS1000 Access Control Server (Time and Attendance Manager) for IP Video Door Phone
 - AP-VP280 Video Phone

IP Telephony Network Diagram

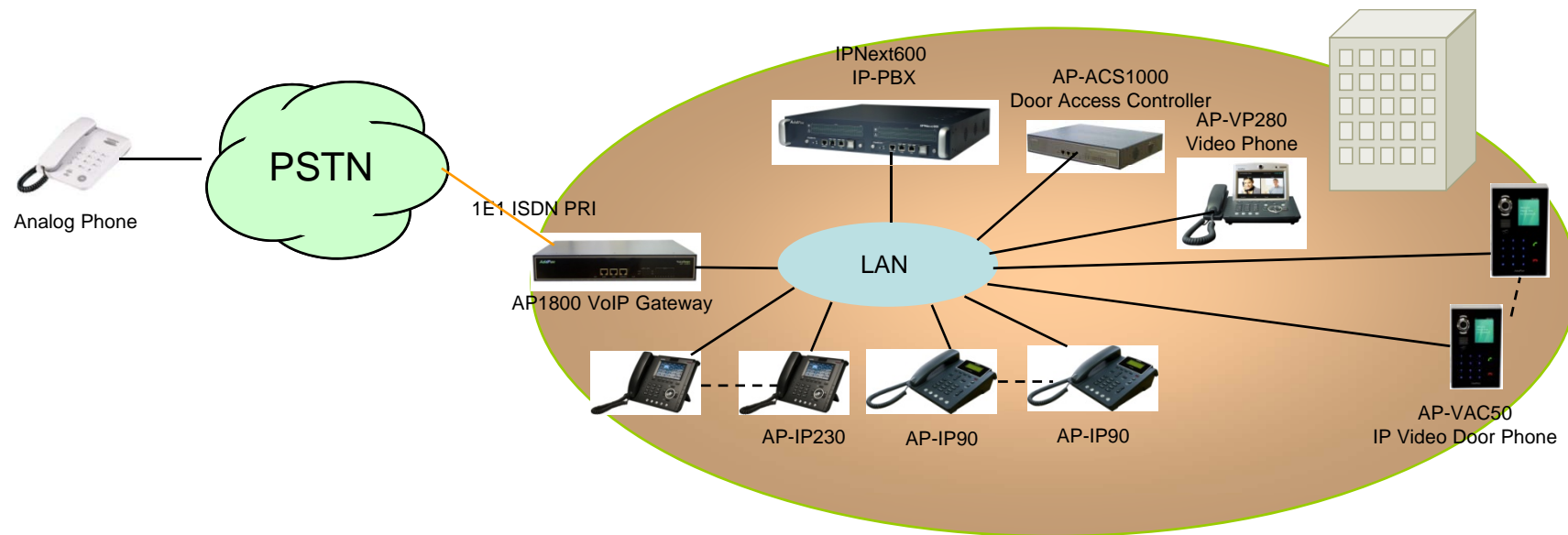



IP Telephony Solution Components

IPNext600 Call Manager



Main Features

IPNext600 Call Manager

- SIP Application Server, Proxy, Registrar and Location Server
- Multiple ITSP Trunk with SIP & H.323 Accounts Support
- Dual System Redundancy Architecture
 - Two(2) Fast Ethernet Interface / System
- High Performance RISC Architecture
- Powerful Network Protocols (PPPoE, DHCP, Static Routing, etc)
- IPv4/IPv6 Dual Stack
- RTP Proxy Function Embedded for Private IP and IPv6 Address Interworking
- User Presence Service Features for Smart Multimedia Messenger and Smart IP Phone
- IVR Scenario Editor, Voice Mail, Media Service (Coloring), Conference
- Firmware Upgradeable Architecture
- Smart Multimedia Manager for IP-PBX Management
- Smart Messenger Service (click to dial) for Unified Communication
- VPMS (VoIP Plug&Play Management System) & Smart NMS for Large Scale Deployment
- Advanced Voice QoS Mechanism
- Dual Redundancy Power Module

Hardware Specification

IPNext600 Call Manager

RISC
CPU

- 64bit High-End Microprocessor Computing Power
- Main Chassis
 - Dual Redundancy CPU Boards for System Fault Tolerant
 - Two(2) 10/100Mbps Gigabit Ethernet
 - One(1) RS-232C Console (RJ45)
 - Dual Redundancy Power Supply Module
 - Hot-Swap Features



Hardware Specification

IPNext600 Call Manager

RISC
CPU

Front Side

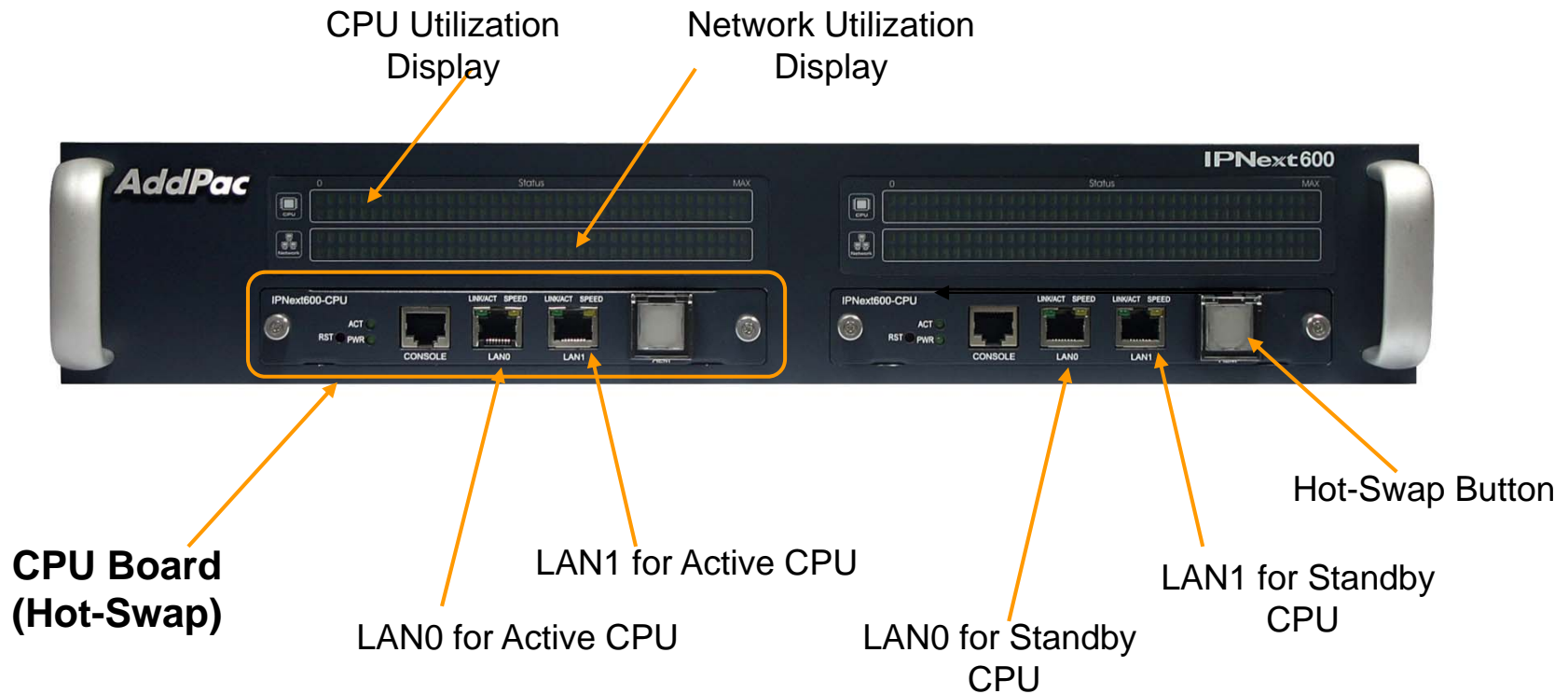

Hardware Specification

IPNext3000 Call Manager



Back Side

Dual Power Supply Modules
(Hot-Swap)



PSU Module A

PSU Module B

Power On/Off Switch
for System

System Redundancy Features

IPNext600 Call Manager

IPNext600 System Block Diagram

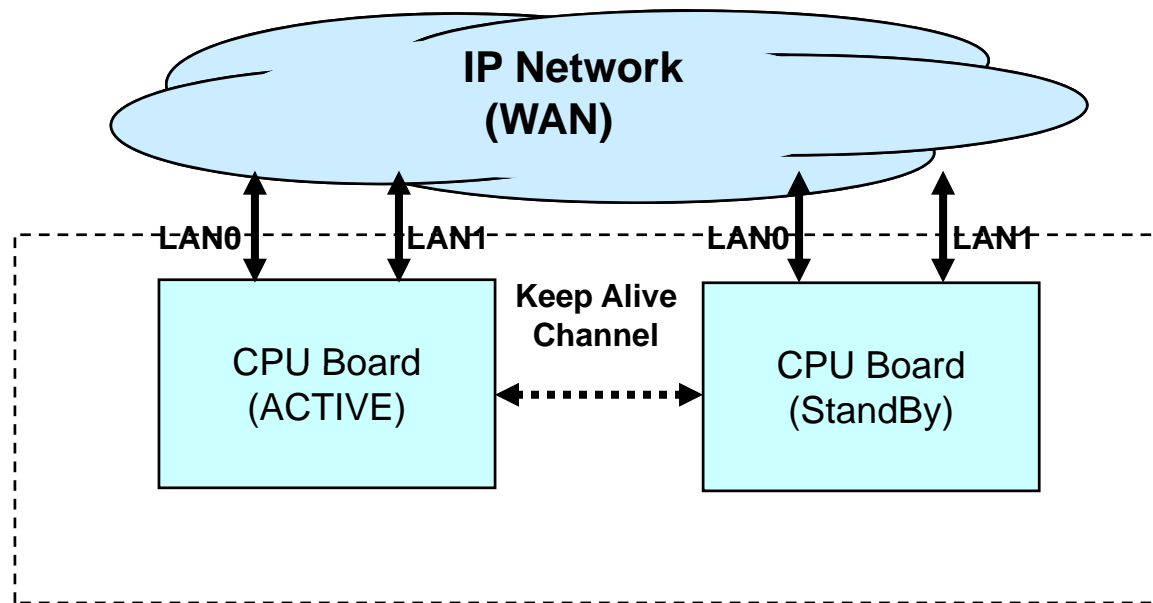

System Redundancy Features

IPNext600 Call Manager

- Active– Active Duplication Scheme
- Active – Standby Duplication Scheme
- VRRP based Duplication Scheme

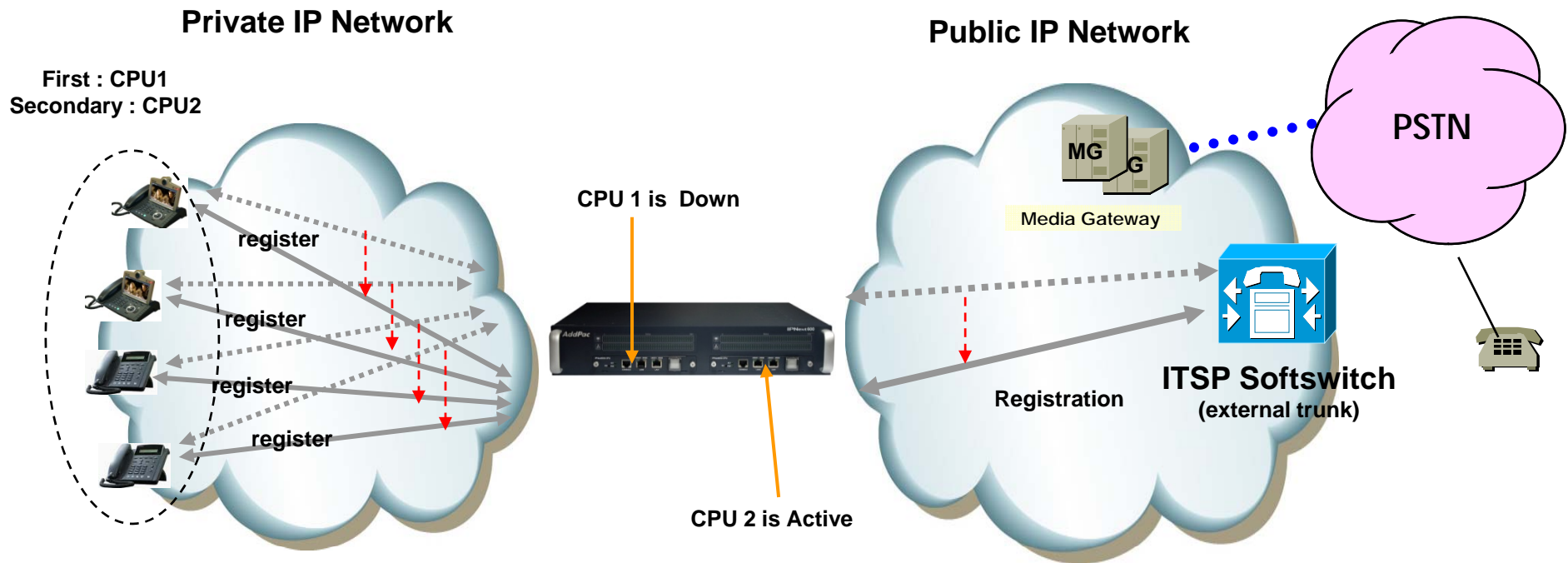

Active – Standby Duplication Scheme (example)



AP1800 VoIP Gateway

Main Features

AP1800 VoIP Gateway

- H.323/SIP/MGCP Triple Concurrent Stack Embedded
- High Performance RISC & Programmable DSP Architecture
- Two(2) 10/100Mbps Fast Ethernet (IP Share ,etc)
- High Performance LAN-to-LAN Routing Capability
- G.711/G.726/G.723/G.729, T.38 Fax , VAD, etc
- Powerful Network Protocols (PPPoE, DHCP, Static Routing, etc)
- Firmware Upgradeable Architecture
- VPMS (VoIP Plug&Play Management System) for Large Scale Deployment
- Advanced Voice QoS Mechanism
- Light and Compact Design with Internal Power Supply
- Two(2) VoIP Module Slot

Hardware Specification

AP1800 VoIP Gateway

RISC
CPU

High-end
DSP

- RISC Microprocessor Computing Power
- Up to 16 Port Analog VoIP Gateway
- Two(2) VoIP Module Slots (Hot-Swap)
 - 8-Port FXS Card, 8-Port FXO Card, 4-Port FXS 4-Port FXO Card , Digital E1/T1 Card
- Network Interface
 - Two(2) 10/100Mbps Fast Ethernet (RJ45)
- RS232C Console Interface
- Run LED, LAN LED, Port LEDs
- Internal Power Supply

Hardware Specification

AP1800 VoIP Gateway

RISC
CPU

High-end
DSP



LAN0 10/100Mbps Ethernet

LAN1 10/100Mbps Ethernet

Console Interface

Port LEDs

Hardware Specification

AP1800 VoIP Gateway

RISC
CPU

High-end
DSP



VoIP Module

Hot-Swap Switch





Power Input

Power Switch



IP Phone

IP Phone Comparison Table

	AP-IP300 	AP-IP230 	AP-IP160 	AP-IP120 	AP-IP90 
LCD Size	4.3 Inch Color LCD	5 Inch Color LCD	4 Text Line Graphic LCD	4 Text Line Graphic LCD	4 Text Line Graphic LCD
Touch Screen	N/A	Support	N/A	N/A	N/A
Speed-Dial Keys	25 Key with Presence LED	Touch Screen based 25 Keys	16 Key with Presence LED	12 Key with Presence LED	N/A
Voice Codec	G.711/G.726/ G.729/G.723	G.711/G.726/ G.729/G.723	G.711/G.726/ G.729/G.723	G.711/G.726/ G.729/G.723	G.711/G.726/ G.729/G.723
Signaling	H.323/SIP	H.323/SIP	H.323/SIP	H.323/SIP	H.323/SIP
3-Party Conversation	Support	Support	Support	Support	Support
LAN Port	2	2	2	2	2
PoE(Optional)	Support	Support	Support	Support	Support
FXO(Optional)	Support	Support	Support	Support	Support



AP-IP230 IP Phone

Main Features

AP-IP230 Premium IP Phone

- 5 Inch Color LCD Display, Touch Screen
- Touch Screen based 25 Speed-Dial Keys
- 4 Soft Key for Call Control
- Various Function Keys
- H.323/SIP Concurrent VoIP Signaling Stack Embedded
- High-performance Voice Codec Support
 - G.711/G.726/G.729/G.723, etc
- Two(2) 10/100Mbps Fast Ethernet (IP Share ,etc)
- High Quality Speaker Phone Features (Acoustic Echo Canceller)
- Powerful Network Protocols (PPPoE, DHCP, Static Routing, etc)
- Firmware Upgradeable Architecture
- VPMS (VoIP Plug&Play Management System) for Large Scale Deployment
- Advanced Voice QoS Mechanism

Hardware Specification

AP-IP230 Premium IP Phone

RISC
CPU +
DSP

- RISC Microprocessor Computing Power
- 5 Inch Color LCD with Touch Screen
- High-end Programmable DSP Hardware Architecture
- High quality Audio and Voice Interface
 - Stereo Audio Input & Output Connector
- Network Interface
 - Two(2) 10/100Mbps Fast Ethernet
 - One(1) USB 1.0 Interface
- PSTN Interface
 - One(1) FXO(RJ11) interface
- Power Supply
 - *External DC adaptor (5V)*
 - *Power Switch*
 - *PoE (Power over Ethernet)*

Hardware Specification

AP-IP230 Premium IP Phone

RISC
CPU +
DSP

5 Inch
LCD with Touch
Screen



Hardware Specification

AP-IP230 Premium IP Phone

RISC
CPU +
DSP

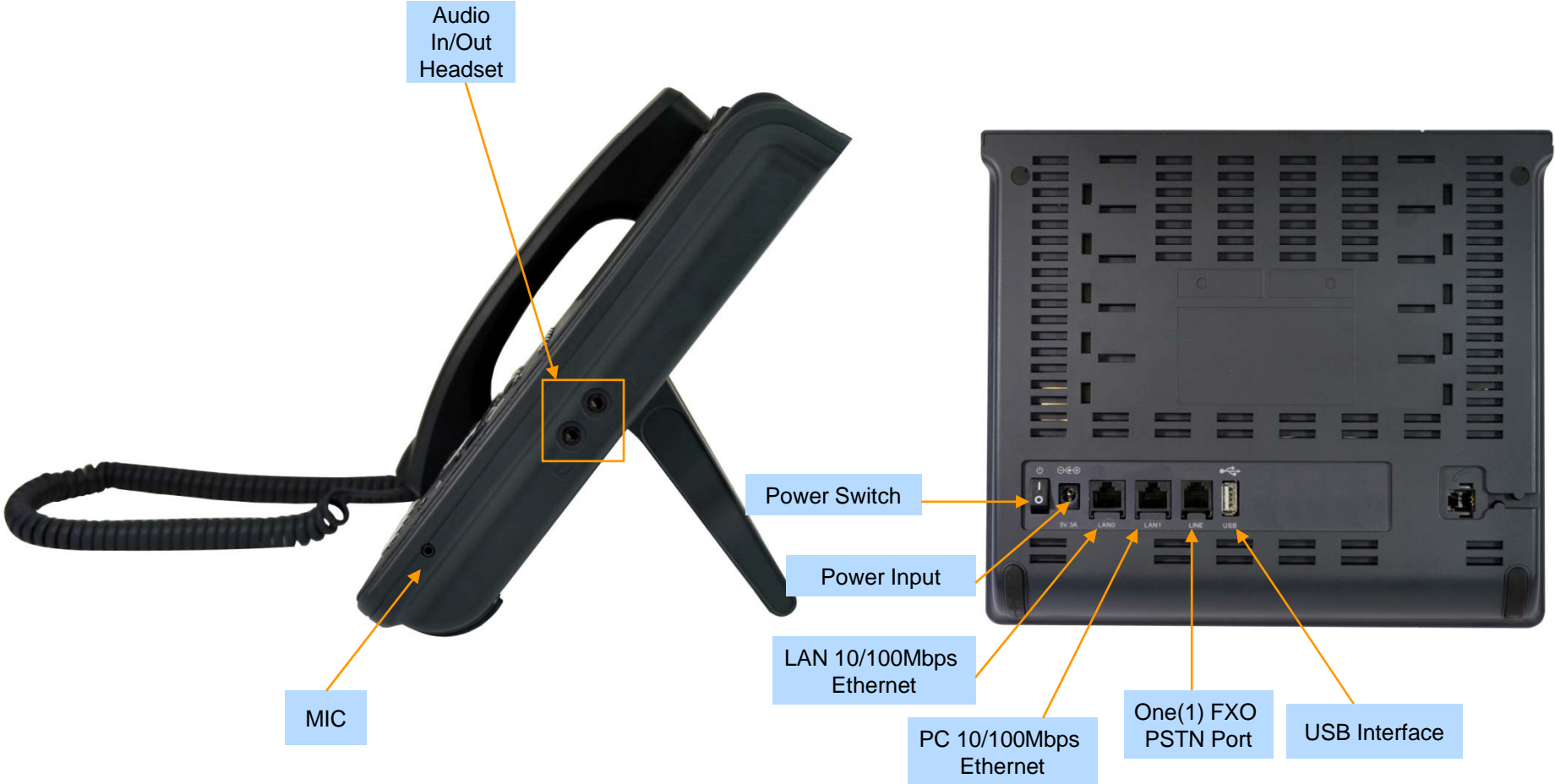



AP-IP90 IP Phone

Main Features

AP-IP90 IP Phone

- 4 Text Line Graphic LCD Display
- 4 Soft Key for Call Control
- Various Function Keys
- H.323/SIP Concurrent VoIP Signaling Stack Embedded
- High-performance Voice Codec Support
 - G.711/G.726/G.729/G.723, etc
- Two(2) 10/100Mbps Fast Ethernet (IP Share ,etc)
- High Quality Speaker Phone Features (Acoustic Echo Canceller)
- Powerful Network Protocols (PPPoE, DHCP, Static Routing, etc)
- Firmware Upgradeable Architecture
- VPMS (VoIP Plug&Play Management System) for Large Scale Deployment
- Advanced Voice QoS Mechanism

Hardware Specification

AP-IP90 IP Phone

RISC
CPU +
DSP

- RISC Microprocessor Computing Power
- 4 Text Line Graphic LCD
- Navigation Key for Menu Search
- High-end Programmable DSP Hardware Architecture
- High quality Audio and Voice Interface
 - Stereo Audio Input & Output Connector
- Network Interface
 - Two(2) 10/100Mbps Fast Ethernet
- PSTN Interface
 - One(1) FXO(RJ11) interface
- Power Supply
 - *External DC adaptor (5V)*
 - *PoE (Power over Ethernet)*

Hardware Specification

AP-IP90 IP Phone

RISC
CPU +
DSP





AP-VAC50 IP Video Door Phone

Main Features

AP-VAC50 IP Video Door Phone

- High Performance IP Video Door Phone Solution
- Video Camera, 3x4 Key, TFT Color LCD, Internal MIC & Speaker
- High Quality 2.4 Inch LCD, 320 x 240 Video Resolution
- SIP VoIP Signaling Stack Embedded
- High-performance Video/Voice Codec Support
 - H.264/MPEG4, G.711, etc
- One(1) 10/100Mbps Fast Ethernet
- PoE(Power over Ethernet) Support
- High Quality Speaker Phone Features
- Powerful Acoustic Echo Canceller Chip Embedded
- Powerful Network Protocols (PPPoE, DHCP, Static Routing, etc)
- Firmware Upgradeable Architecture
- Advanced Voice QoS Mechanism

Hardware Specification

AP-VAC50 IP Video Door Phone

RISC
CPU

High-end
DSP

- RISC+DSP Microprocessor Computing Power
- Audio and Voice Interface
 - Internal MIC
 - Internal Speaker
 - 3 x 4 key PAD
- Video Camera Interface
- TFT Color LCD Interface
 - 2.4 Inch LCD, 320 x 240 Video Resolution
- Network Interface
 - One(1) 10/100Mbps Fast Ethernet
- RF Card Interface
- Alarm & Relay Out Interface (door open, etc)
- RS232/RS485 Interface
- External RCA Audio Line Out and MIC In (back side)
- Power Supply
 - Power over Ethernet (Option)
 - External Power Supply



Hardware Specification

AP-VAC50 IP Video Door Phone

RISC
CPU

High-end
DSP

- **Acoustic Echo Canceller**
 - Full-duplex operation during double-talk situations
 - One channel AEC, one channel LEC up to 256ms shared
 - Cancels echoes with up to 10dB echo return
 - Advanced noise reduction(up to 20dB)
- **Speaker**
 - Impedance : 8 +-15%ohm at 1kHz, 1.0 Vrms
 - Sound Pressure : 90 +- 3dB at 0.1W/10 CM
at 800Hz, 1.0kHz, 1.2kHz, 1.5kHz
 - Resonance Level : 550Hz +- 20%Hz at Fo Hz, 1.0Vrms
 - Frequency Range : Fo Hz ~20kHz
 - Input Power : Normal : 1.0 W, Max : 2.0W
- **Audio Amplifier**
 - 1-W BTL Output(5V, 0.11 % THD+N)
 - Uncompensated Gains of 2 to 20 (BTL Mode)
 - Thermal and Shot-circuit Protection
 - High Supply Ripple Rejection Ratio
- **PoE(Power over Ethernet)**
 - IEEE802.3af compliant
 - Input voltage range 36V to 57V
 - Short-circuit Protection



Hardware Specification

AP-VAC50 IP Video Door Phone

RISC
CPU

High-end
DSP

- **LCD Controller**
 - One-Chip Solution for amorphous TFT-LCD
 - Support resolution up to 240xRGBx320
 - Built-in 172800 bytes internal RAM
 - 6,8,16, and 18-bit RGB Interface
 - Resize Function (x ½, x ¼)
 - On-Chip Power Management System
- **Camera**
 - High Sensitivity for low-light operation
 - Output support for Raw RGB, RGB, and YCrCb format
 - Image Size : VGA, QVGA, and any size scaling down from CIF to 40x30
 - Support AEC, AGC,AWB, ABF, ABLC
 - Saturation Level, Edge Enhancement Level, De-noise level Auto adjust

Hardware Specification

AP-VAC50 IP Video Door Phone

RISC
CPU

High-end
DSP

- RF Card Sensor
 - Protocol Supported
 - ISO14443A/B all bit rates
 - > 106,212,424 and 848 kbps
 - Compatible to MiFare Classic
 - ISO15693 all modes
 - > 1.65/6.6 & 26.5 kbps
 - > Uplink 1 & 2 sub-carrier
 - Receiver
 - Rx Sensitivity down to 1mVrms
 - Rx Automatic Gain Control
 - Accept external baseband signal from external circuitry for frame level processing
 - Integrated signal strength indicator (SSI)
 - On-Chip Framing handler for supported standard
 - Transmitter
 - Typical proximity operating distance up to 100mm.
 - Software configurable modulation index
 - Maximum driving current up to 200 mA/PIN @ 5V
 - Accept external baseband signal for RF modulation
 - Wide Transmitter driver supply range from 2.7~7.0V



RF Card Sensor

Hardware Specification

AP-VAC50 IP Video Door Phone

RISC
CPU

High-end
DSP

Front Side

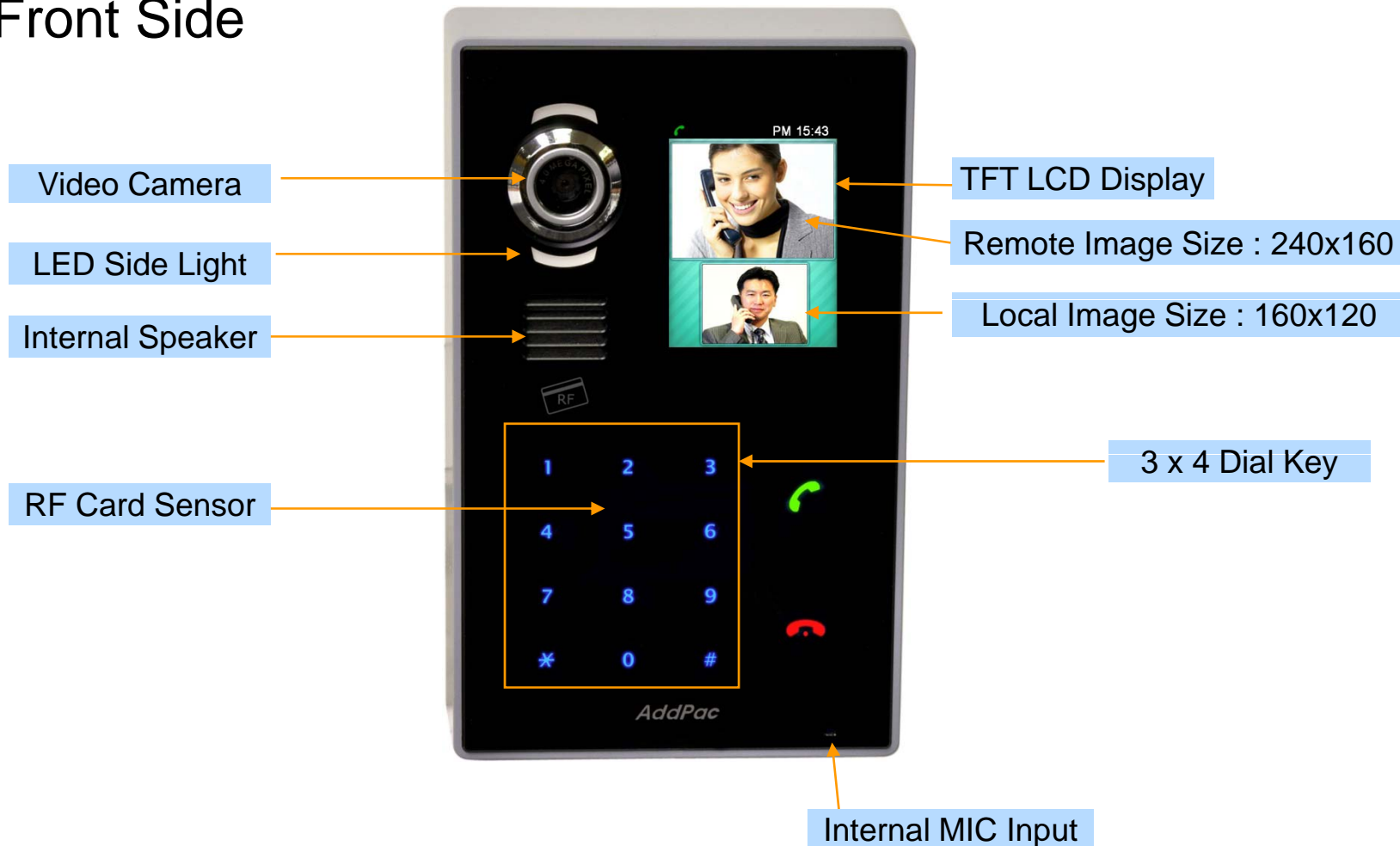

Hardware Specification

AP-VAC50 IP Video Door Phone

RISC
CPU

High-end
DSP

Back Side

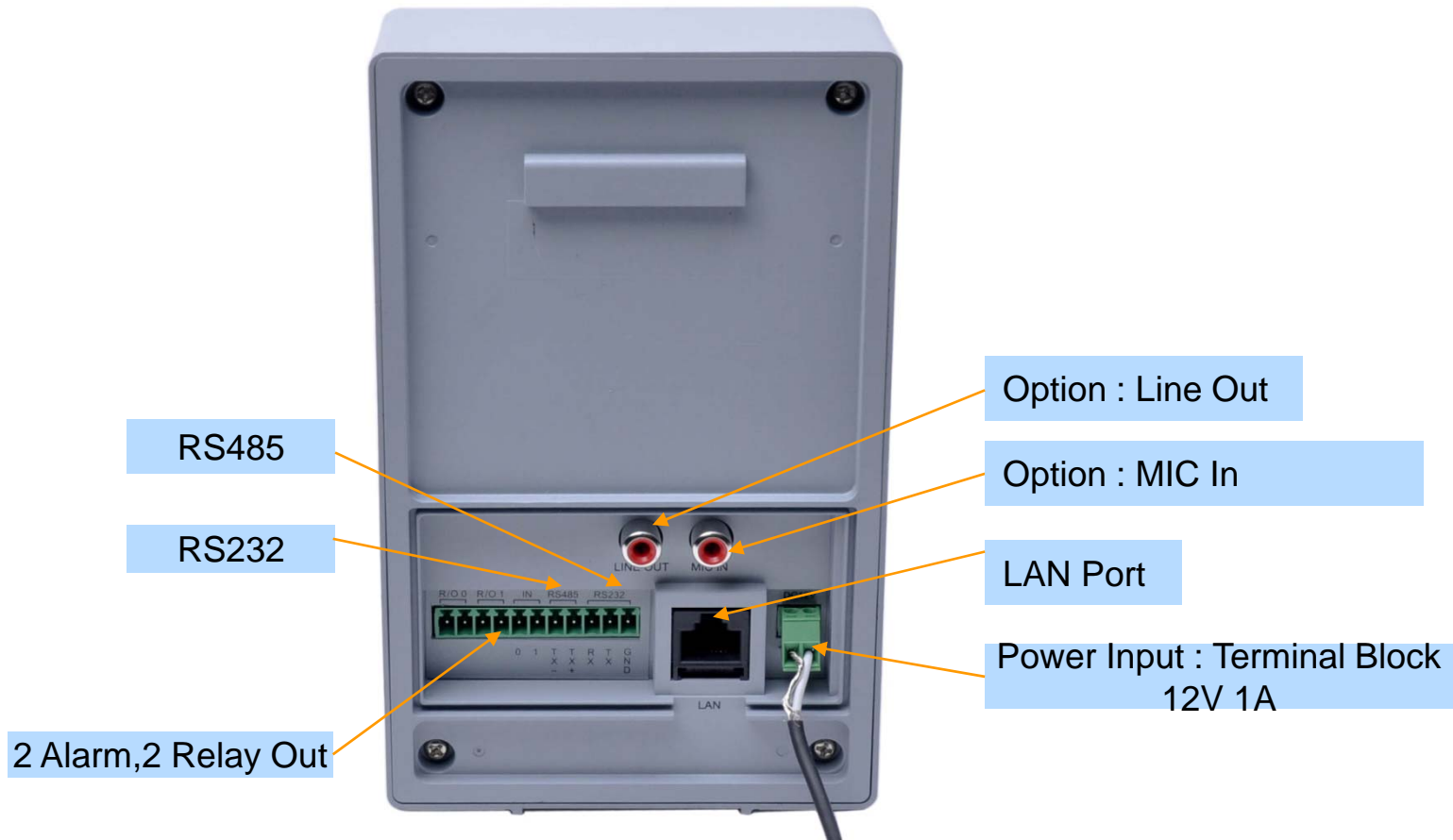

Hardware Specification

AP-VAC50 IP Video Door Phone

RISC
CPU

High-end
DSP

Back Side



Wall Mount Bracket

Rubber Cover for light waterproof

Hardware Specification

AP-VAC50 IP Video Door Phone

RISC
CPU

High-end
DSP

Power Supply

Terminal Block



12V 1A Power Adaptor

Example



AP-ACS1000 DACS (Door Access Control System)

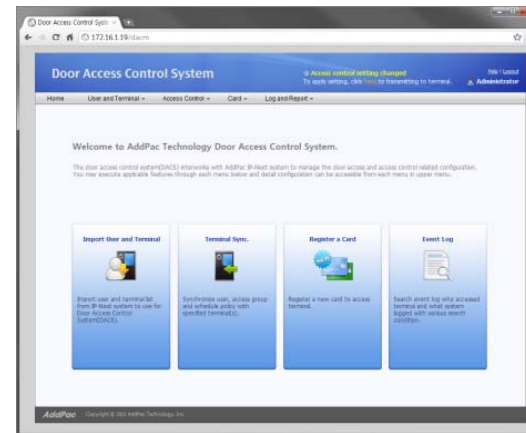

Contents

- DACS Network Service Diagram
- Login Web Page
- Time & Attendance Management
 - Daily Attendance Management
 - Monthly Attendance Management
 - Business Trip and Vacation Management
 - Time & Attendance Codes
 - Attendance Report Management
 - Attendance Report by Date, Month
 - Attendance Daily Report by Month
 - Attendance Personal Report

DACS (Door Access Control System)

Integrated Door Access Control and Call Control

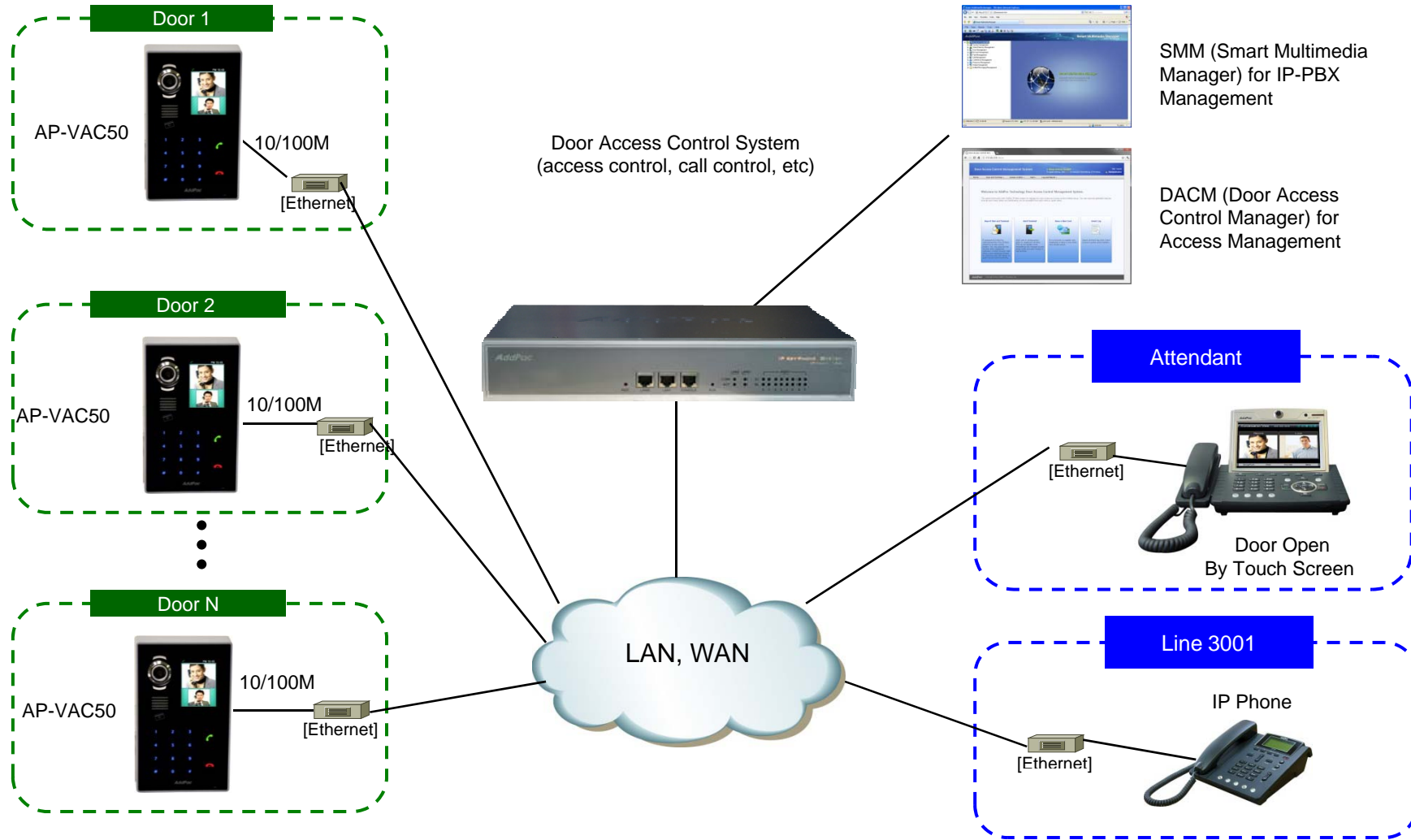

DACS (Door Access Control System)

Login page

The screenshot shows a web browser window with the URL `172.16.1.19/index.php`. The page title is "Door Access Control System". The main content area features the "AddPac Door Access Control System" logo and a login form with the following fields:

- Administrator ID:
- Password:

Below the login form are two buttons:

- Door Access Control Manager**: Includes a green arrow icon and a smartphone icon.
- Time and Attendance Manager**: Includes a green arrow icon and a clock/chart icon.

Annotations on the screenshot:

- A yellow box at the top contains the text: "You can log on 'Door Access Control Manager' or 'Time and Attendance Manager' if license is valid and administrator have authentication right". A yellow arrow points from this box to the login form.
- A blue box on the left contains the text: "Log on to Door Access Control Management". A blue arrow points from this box to the "Door Access Control Manager" button.
- A blue box on the right contains the text: "Log on to Time and Attendance Management". A blue arrow points from this box to the "Time and Attendance Manager" button.

TAAM (Time and Attendance Manager)

Main Web Page

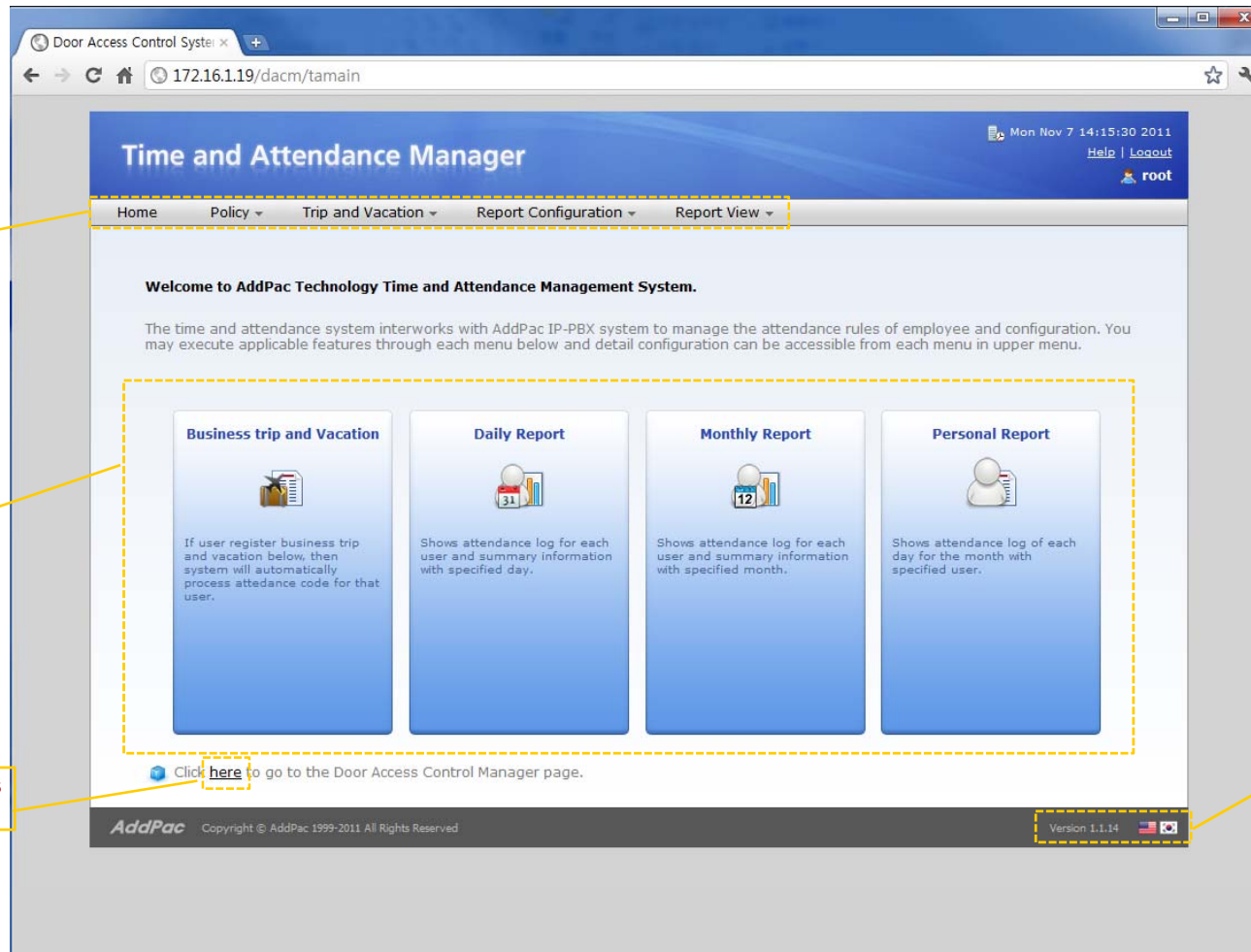

main menu & sub menu

quick menu for frequent use

switch to "Door Access Control Manager"

show current version and language

TAAM (Time and Attendance Manager)

Daily Attendance Rules

shows In (office-in time), Out (office-out time) and Regular working time, for example 9 hours

This day rule can be used in the monthly rule for sunday through saturday each.

Name	Description	In	Out	Regular Hour	Date Created
1 default rule	default daily rule	09:00	18:00	9 hr	
2 Factory First Rule	Factory first daily work rule	08:00	20:00	12 hr	2011-11-07 14:32:2
3 Factory Second Rule	Factory second daily work r...	20:00	08:00	9 hr	2011-11-07 14:33:1

1. Daily Rule
Defines rule for work start time(in), work end time(out) and regular hour of the day. Day start time is used as basis of the day.

Rule Name*
Description
Day Start Time 06:00
In 09:00
Out 18:00
Regular Hour 9 Hour

2. Allowable time and overtime

For Late 10 Min.
Leaving Work Early 10 Min.
Minimum Overtime 2 Hour

To apply this features, please select 'Add' or 'Apply' button. To cancel, Select 'Cancel' button.

TAAM (Time and Attendance Manager)

Monthly Attendance Rules

Door Access Control System

172.16.1.19/dacm/monthlyWorkRuleList

Monthly Attendance Rule List

Shows list of monthly based attendance rule for time(week, full day off, national holiday)

Name	Description
1 Default Rule	Default attendance rule
2 Head Office Rule	Head office work monthly rule
3 Factory First Rule	Factory first work monthly rule
4 Factory Second Rule	Factory second work monthly rule

Door Access Control System

Access control setting changed
To apply setting, click [here](#) to transmitting to terminal.

Home User and Terminal Access Control Card Time and Attendance Log and Report

Monthly Attendance Rule

1. Monthly Rule

Defines day off or work day from starting first week to sixth week of the month. Each day of the week can be applied to daily-based attendance rule.

Rule Name*

Description

1st week Sun Mon Tue Wed Thu Fri Sat

2nd week Sun Mon Tue Wed Thu Fri Sat

3rd week Sun Mon Tue Wed Thu Fri Sat

4th week Sun Mon Tue Wed Thu Fri Sat

5th week Sun Mon Tue Wed Thu Fri Sat

6th week Sun Mon Tue Wed Thu Fri Sat

*Clicked: Full Day Off *Non-Clicked: Work Day

Sunday N/A

Monday N/A

Tuesday N/A

Wednesday N/A

Thursday N/A

Friday N/A

Saturday N/A

2. Holiday Rule

Defines rule for non-working day such as national holiday, user defined holiday in the day template.

Day Template List

Name	Description
public holiday	public holiday description
company holiday	company holiday description

List of applied Day Templates

Name	Description
------	-------------

AddPac Copyright © AddPac 1999-2011 All Rights Reserved

TAAM (Time and Attendance Manager)

Business Trip and Vacation

The screenshot shows the 'Business Trip and Vacation' section of the TAAM application. It includes a table with two entries and three callout boxes explaining specific features.

Name	Description	User	Type	Start	End	Date Created	Modify	Delete
1 Rusia Business...	Presentation for Ne...	Total 2 includin...	Business trip	2011-09...	2011-10...			
2 Summer Vacati...			Vacation	2011-08...	2011-08...	2011-10-12 07:...		

one or more user can be specified for each business trip and vacation rule.

Extension user will be not processed as absentee between start day and end day, also log as user-defined time attendance code

user-defined time and attendance code for attendance report or log correction

TAAM (Time and Attendance Manager)

Time and Attendance Codes

The screenshot shows a web browser window with the URL `172.16.1.19/dacm/timeAttendanceCodeList`. The page title is "Time and Attendance Manager" and the user is logged in as "root". The main content area is titled "Time and Attendance Codes" and includes a description: "Shows list of user defined attendance code which can be used as correction in the attendance report." Below this is a table with columns for Name, Description, Date Created, Modify, and Delete. A "Add a Code" button is located to the right of the table. Three callout boxes provide additional information: one points to the first three rows (Unknown, Not yet defined, Late In), another points to the 'Delete' column, and a third points to the entire table.

Name	Description	Date Created	Modify	Delete
1 Unknown				
2 Not yet defined				
3 Late In				
4 Early Out				
5 Absence				
6 Late In/Early Out				
7 Normal				
8 Vacation				
9 Business trip				
10 Sick Leave	Sick Leave code by admin	2011-11-07 14:44:15		

system built-in time and attendance code is provided as default, for example late-in, early-out and absence

show built-in and user-defined time and attendance code which will be used in the attendance report and log correction

only user-define code can be removed if needed

TAAM (Time and Attendance Manager)

Delivery Policy for Attendance Report

1. Report Policy
Defines email delivery policy for manager or each user to receive daily, monthly attendance report.

Send reports to the particular person every day at 08:00

Send reports to the particular person at specific day (28) of every month.

User List
Search Field: Last Name

Name	Department	Extension
batista Eike	/2F/	1000
Stefan Persson	/2F/	1016

Send personal monthly report to each user.

2. SMTP Server
You can specify sending email server(SMTP) configurations.

SMTP Server: 61.33.161.2

Sender Email Address: dacs_admin@company.com

Server Authentication Required

User ID: admin

Password: ****

To apply this features, select 'Apply' or 'Cancel'

Apply Cancel

AddPac Copyright © AddPac 1999-2011 All Rights Reserved Version 1.1.14

manager level users (extension) list who want to receive daily and monthly attendance report

if checked, system will send personal attendance report of each month to extension user

TAAM (Time and Attendance Manager)

Attendance Report by Date

Time and Attendance Manager

Mon Nov 7 14:52:05 2011 Help | Logout root

Home Policy Trip and Vacation Report Configuration Report View

Attendance Report by Date
Shows attendance log for each user and summary information with specified day.

Select Date : 2011-10-19

Select Department : All

Attendance Report by Date (2011-10-19)

Username	Department	In	Out	Overtime	Office Hc	Result	Correction Ti	Correct
1 Eike batista	smart management팀	08:05:00	18:05:00	0 hr	10:0...	Normal		
2 Bill Gates	multimedia팀	09:15:00	17:15:00	0 hr	08:0...	Normal	2011-11-...	
3 Larry Ellison	multimedia팀	09:00:00	18:00:00	0 hr	09:0...	Normal		
4 karl Albrecht	smart framework팀	09:00:00	17:00:00	0 hr	08:0...	Early Out		
5 Carlos Slim Helu	smart management팀	09:10:00	19:10:00	0 hr	10:0...	Normal		
6 Lakshmi Mittal	multimedia팀	09:00:00	18:00:00	4 hr	09:0...	Normal		
7 Christy Walton	smart framework팀	09:00:00	18:00:00	0 hr	09:0...	Normal		

You can export to excel or print out for attendance report

attendance summary for each time and attendance code with specified date

administrator may adjust or correct attendance log which system have processed if necessary

TAAM (Time and Attendance Manager)

Attendance Report Excel Export

Attendance Report by Date (2011-10-19)							
Username	Department	In	Out	Overtime	Office Hours	Result	Correction Time
Eike batista	smart management	08:05:00	18:05:00	0 hr	10:00:00	Normal	
Bill Gates	multimedia	09:15:00	17:15:00	0 hr	08:00:00	Normal	2011-11-07 14:52:28
Larry Ellison	multimedia	09:00:00	18:00:00	0 hr	09:00:00	Normal	
karl Albrecht	smart framework	09:00:00	17:00:00	0 hr	08:00:00	Early Out	
Carlos Slim Helu	smart management	09:10:00	19:10:00	0 hr	10:00:00	Normal	
Lakshmi Mittal	multimedia	09:00:00	18:00:00	4 hr	09:00:00	Normal	
Christy Walton	smart framework	09:00:00	18:00:00	0 hr	09:00:00	Normal	
Lika Shing	smart framework	09:20:00	18:20:00	0 hr	09:00:00	Late In	
Stefan Persson	smart framework	09:00:00	20:00:00	2 hr	11:00:00	Normal	
Warren Buffett	multimedia	09:15:00	18:15:00	0 hr	09:00:00	Normal	
Amancio Ortega	smart management	09:00:00	21:00:00	3 hr	12:00:00	Normal	
Mukesh Ambani	smart management	09:00:00	18:30:00	0 hr	09:30:00	Normal	

TAAM (Time and Attendance Manager)

Attendance Report by Month

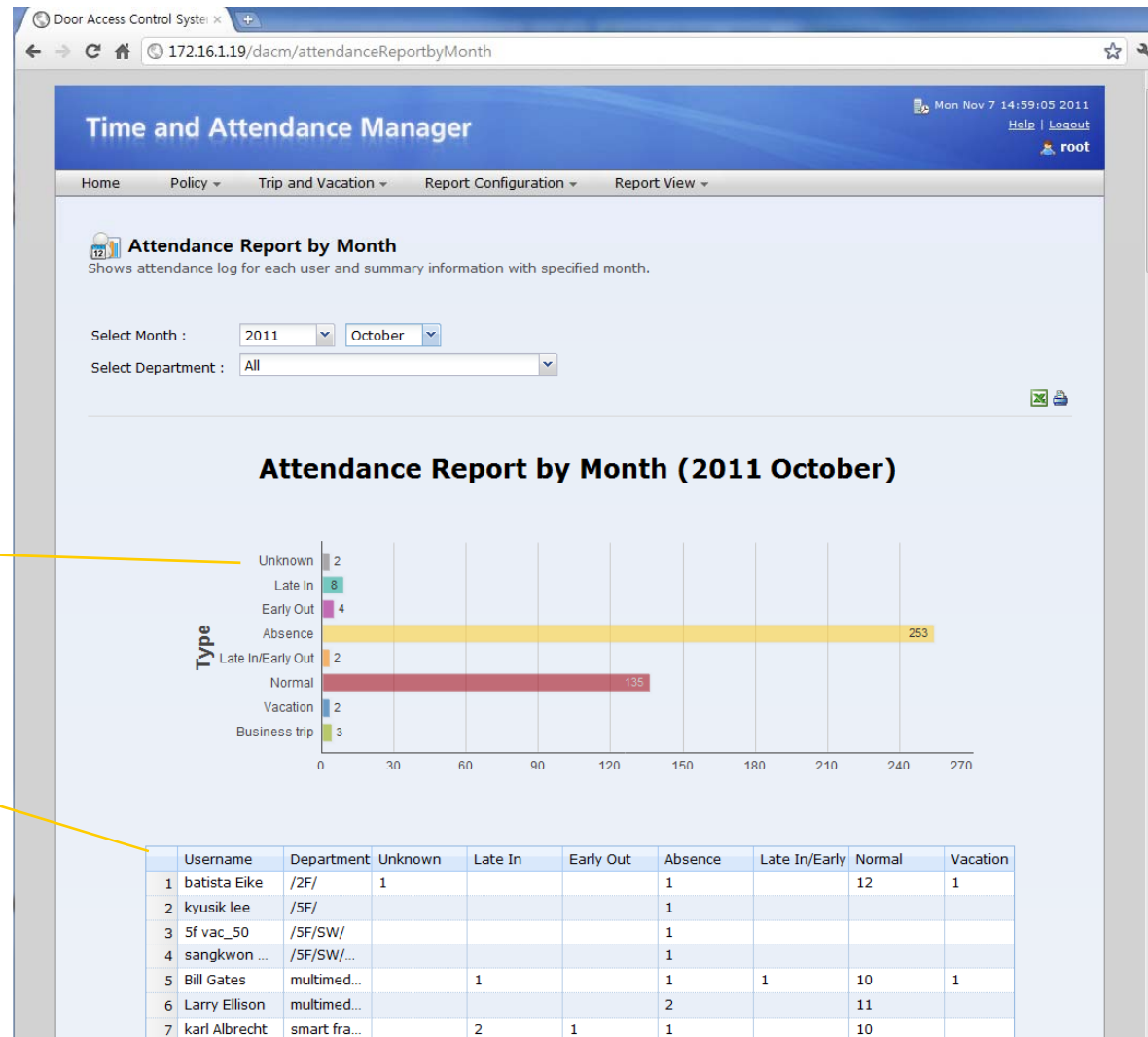

attendance summary for each time and attendance code with specified month

attendance summary for each extension user

TAAM (Time and Attendance Manager)

Attendance Daily Report by Month

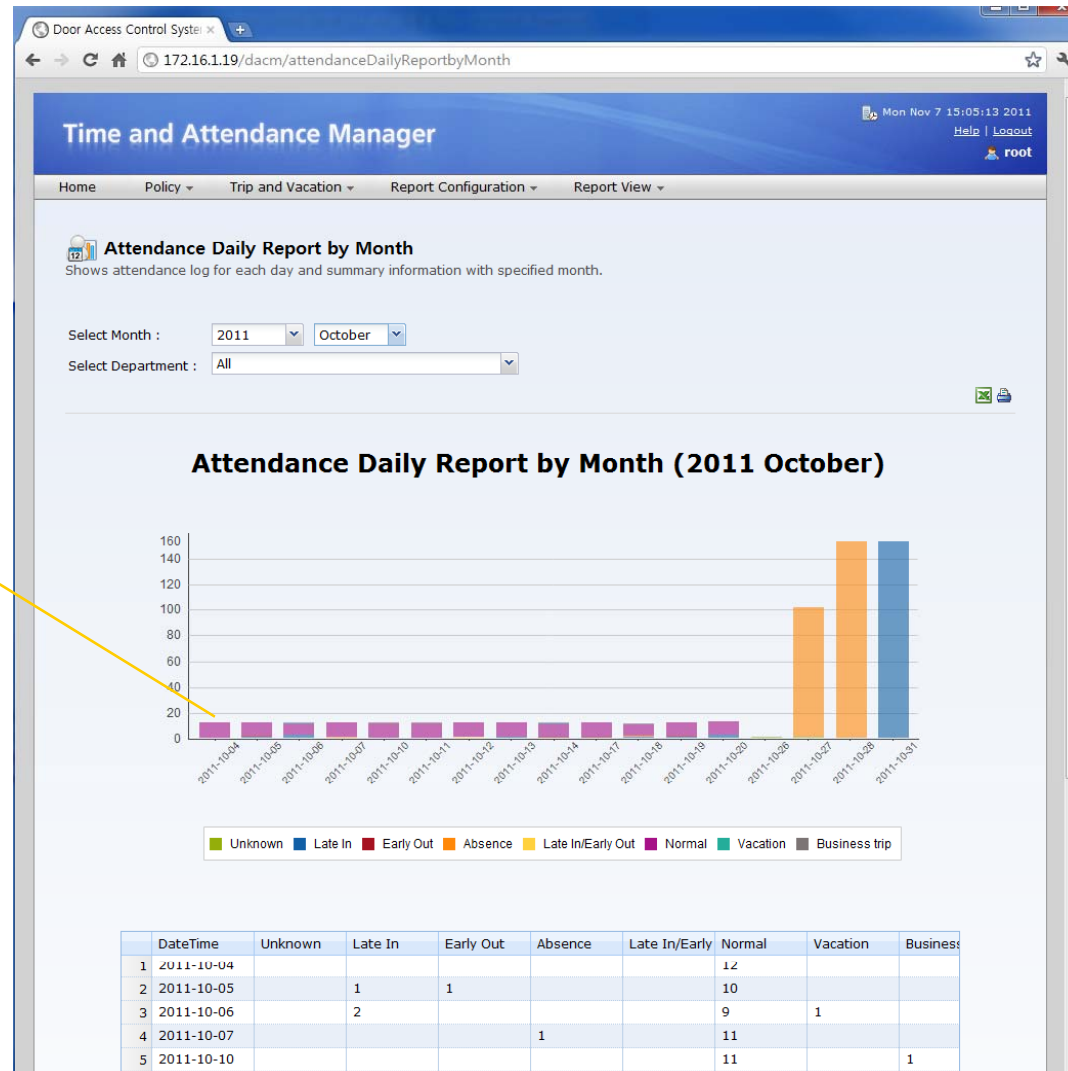

clustered column of attendance summary with time span from first to end of the month

TAAM (Time and Attendance Manager)

Attendance Personal Report

Attendance Personal Report
Shows attendance log of each day for the month with specified user.

Select Month : 2011 | October
Select User : Carlos slim Helu

Attendance Personal Report (2011 October)
Carlos slim Helu (/2F/)

Type

Type	Count
Late In	1
Early Out	2
Absence	1
Normal	10
Business trip	1

	DateTime	In	Out	Overtime	Office Hours	Result
1	2011-10-04	09:00:00	18:00:00	0 hr	10:00:00	Normal
2	2011-10-05	09:00:00	18:00:00	0 hr	10:00:00	Normal
3	2011-10-06	09:00:00	18:00:00	0 hr	10:00:00	Normal
4	2011-10-07	09:00:00	18:00:00	0 hr	10:00:00	Normal
5	2011-10-10	09:10:00	19:10:00	0 hr	10:00:00	Normal
6	2011-10-11	09:10:00	19:10:00	0 hr	10:00:00	Normal
7	2011-10-12	09:10:00	19:10:00	0 hr	10:00:00	Normal
8	2011-10-13	09:10:00	19:10:00	0 hr	10:00:00	Normal
9	2011-10-14	09:10:00	17:10:00	0 hr	08:00:00	Early Out









You can specify one extension user for attendance report of the month

attendance summary for time and attendance code of a extension user



AP-VP280
Video Phone
for IP Video Door Phone
Service

IP Video Phone Comparison Table

	AP-VP500	AP-VP350	AP-VP300N	AP-VP280	AP-VP250	AP-VP230	AP-VP150	AP-VP120
								
LCD Size	12.1 Inch Touch Screen	7Inch Touch Screen	7Inch Touch Screen	7Inch Touch Screen	4.3Inch Touch Screen	5Inch Touch Screen	4.3Inch Touch Screen	4.3Inch
Camera	CCD	CCD	CCD	CMOS	CMOS	CMOS	CCD	CMOS
Video Codec	H.263 MPEG4 H.264	H.263 MPEG4 H.264	H.263 MPEG4 H.264	H.263 MPEG4 H.264	H.263 MPEG4 H.264	H.263 MPEG4 H.264	H.263 MPEG4 H.264	H.263 MPEG4 H.264
Signaling	H.323/SIP	H.323/SIP	H.323/SIP	H.323/SIP	H.323/SIP	H.323/SIP	H.323/SIP	H.323/SIP
Video MCU	N/A	4-Party Video MCU	N/A	N/A	N/A	N/A	N/A	N/A
Voice MCU	3-Party	3-Party	3-Party	3-Party	3-Party	3-Party	3-Party	3-Party
LAN Port	2	2	2	2	2	2	2	2
PoE	N/A	N/A	Support	N/A	Support	Support	Support	Support

Main Features

AP-VP280 Video Phone

- 7 Inch LCD Display, Touch Screen
- H.323/SIP Concurrent VoIP Signaling Stack Embedded
- High-performance Video Codec Support
 - H.263, MPEG-4, JPEG, and H.264
- Powerful Image Resolution Support
 - QCIF(176x144), CIF(352x288), QVGA(320x240), and VGA(640x480)
- Two(2) 10/100Mbps Fast Ethernet (IP Share ,etc)
- G.711/G.726/G.723/G.729, etc
- Powerful Network Protocols (PPPoE, DHCP, Static Routing, etc)
- Rate Control for Video Traffic QoS
 - Ensuring Optimized Quality, Frame Rate with Limited Bandwidth
- Firmware Upgradeable Architecture
- VPMS (VoIP Plug&Play Management System) for Large Scale Deployment
- Advanced Voice QoS Mechanism

Hardware Specification

AP-VP280 Video Phone

RISC
CPU

High-end
DSP

- RISC Microprocessor Computing Power
- CMOS Image Sensor, Samsung LCD, Touch Screen
- High-end Programmable DSP Hardware Architecture
- Powerful Video Interface
 - RCA Video Input/Output, S-Video Output
- High quality Audio and Voice Interface
 - Stereo Audio Input & Output Connector
- Network Interface
 - Two(2) 10/100Mbps Fast Ethernet
 - One(1) RS-232C Console
 - One(1) USB 1.0 Interface
- PSTN Interface
 - One(1) FXO(RJ11) interface
- Power Supply
 - *External DC adaptor (5V)*

Hardware Specification

AP-VP280 Video Phone

RISC
CPU

High-end
DSP



Hardware Specification

AP-VP280 Video Phone

RISC
CPU

High-end
DSP

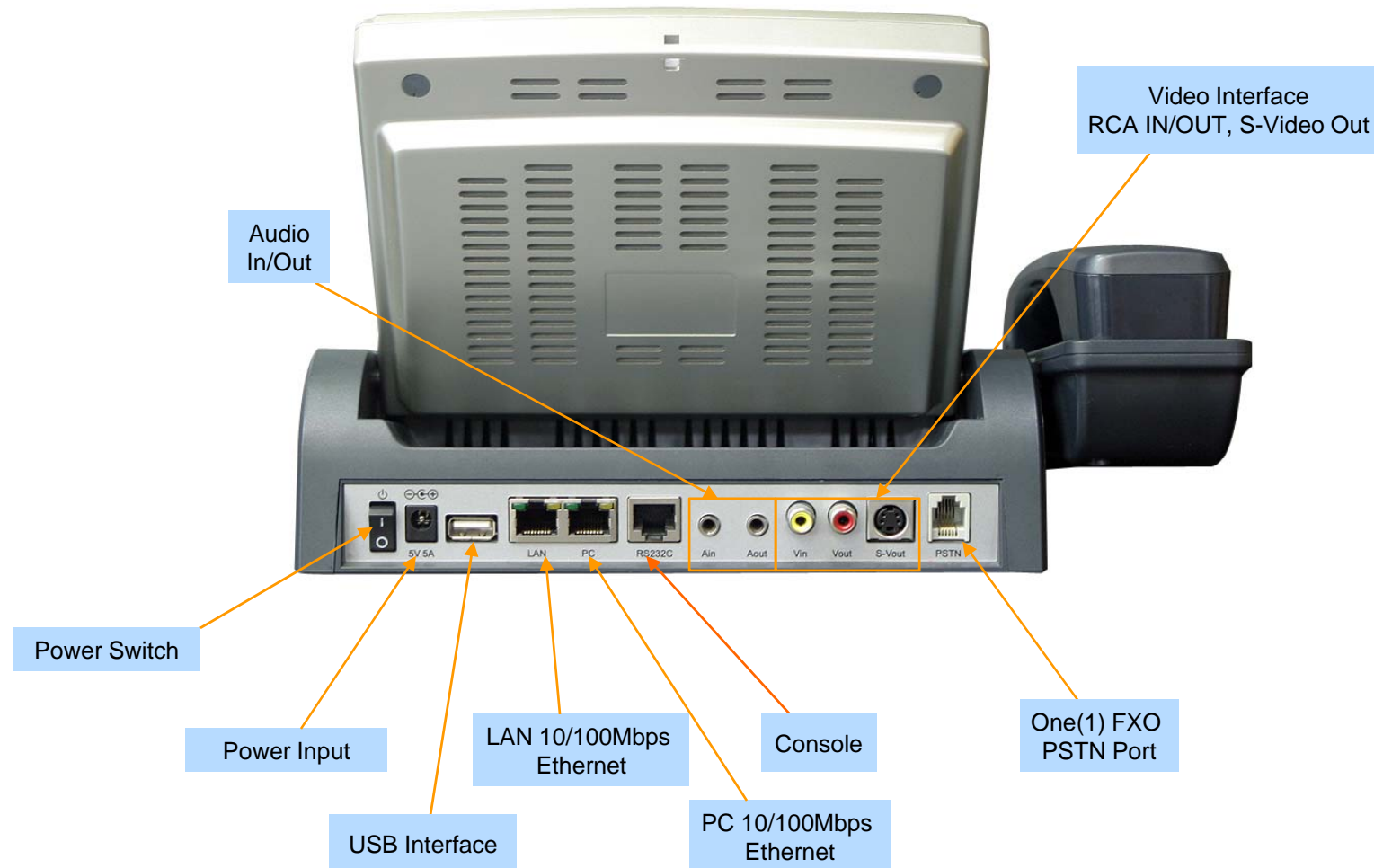



Thank you!

AddPac Technology Co., Ltd.
Sales and Marketing

Phone +82.2.568.3848 (KOREA)

FAX +82.2.568.3847 (KOREA)

E-mail sales@addpac.com