

IPNext150™ NGN IP-PBX

High-performance Next Generation IP-PBX Solution



AddPac

AddPac Technology

2007, Sales and Marketing

APOS Internetworking Protocol

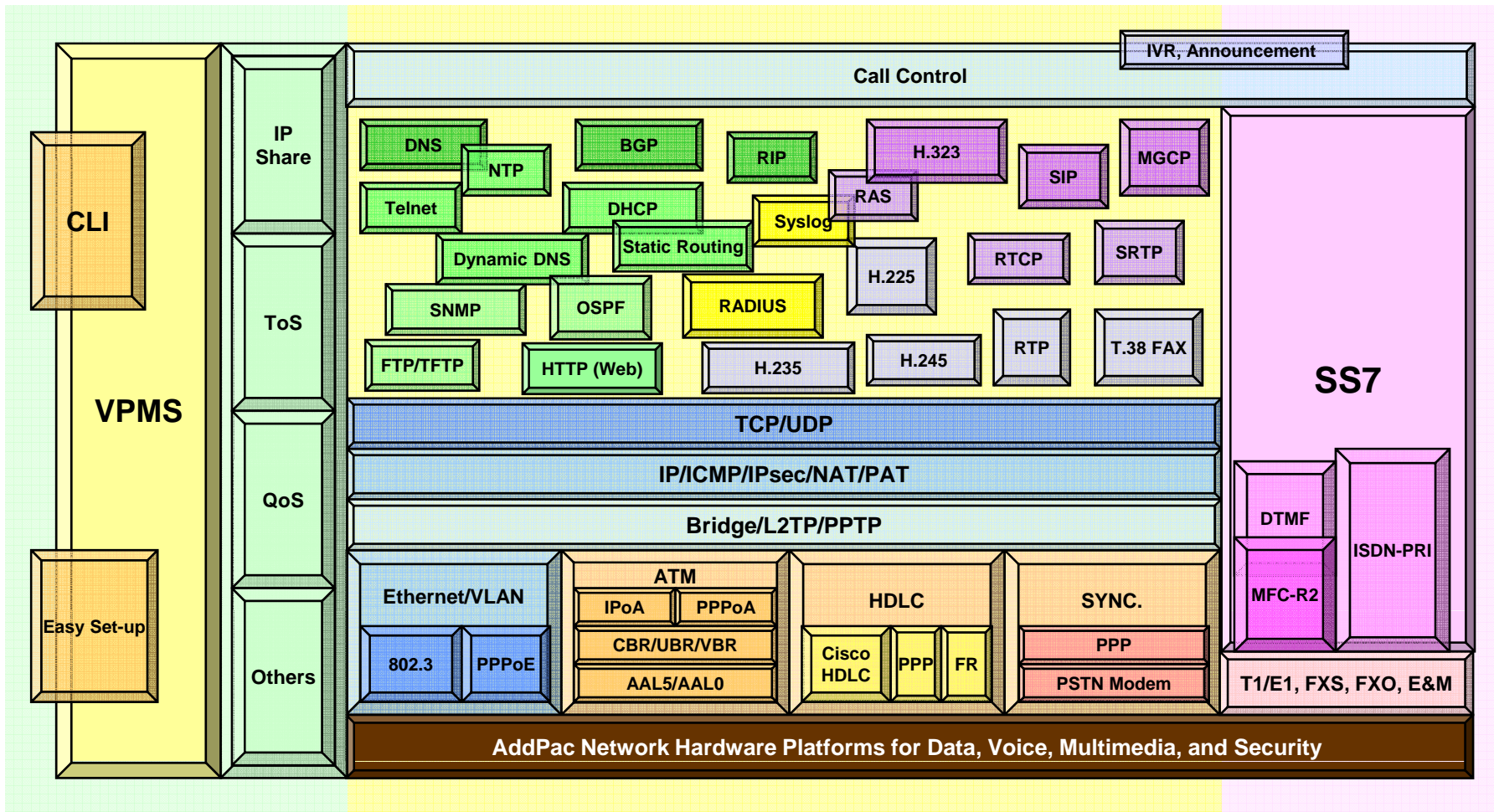

Contents

- Product Overview
- Hardware Specification
- Multimedia Service
- Software Service
- IP-PBX Service Features
- Network Service and Features
- Smart Multimedia Manager
- User Terminals
- Smart Messenger
- Application Area
- Ordering Information



Product Overview

IPNext150 Next Generation IP-PBX

- SIP Application Server, Proxy, Registrar and Location Server
- Multiple ITSP Trunk with SIP & H.323 Accounts Support
- High Performance Programmable RISC Architecture
- Two(2) 10/100Mbps Fast Ethernet (IP Share ,etc)
- High Performance LAN-to-LAN Routing Capability
- Powerful Network Protocols (PPPoE, DHCP, Static Routing, etc)
- IPv4/IPv6 Dual Stack
- RTP Proxy Function Embedded for Private IP and IPv6 Address Interworking
- Presence Service Features for Smart Multimedia Messenger and Smart IP Phone
- IVR Scenario Editor, Voice Mail, Third Party Conference (G.711)
- Firmware Upgradeable Architecture
- Smart Multimedia Manager for IP-PBX Management
- Smart Messenger Service for UC
- VPMS (VoIP Plug&Play Management System) for Large Scale Deployment
- Advanced Voice QoS Mechanism
- Small, Light and Compact Design
- 2.5 Inch Hard Disk
- Power Switch for Stability and Status LEDs

Product Highlights

IPNext150 Next Generation IP-PBX

IP based Advanced IP-PBX

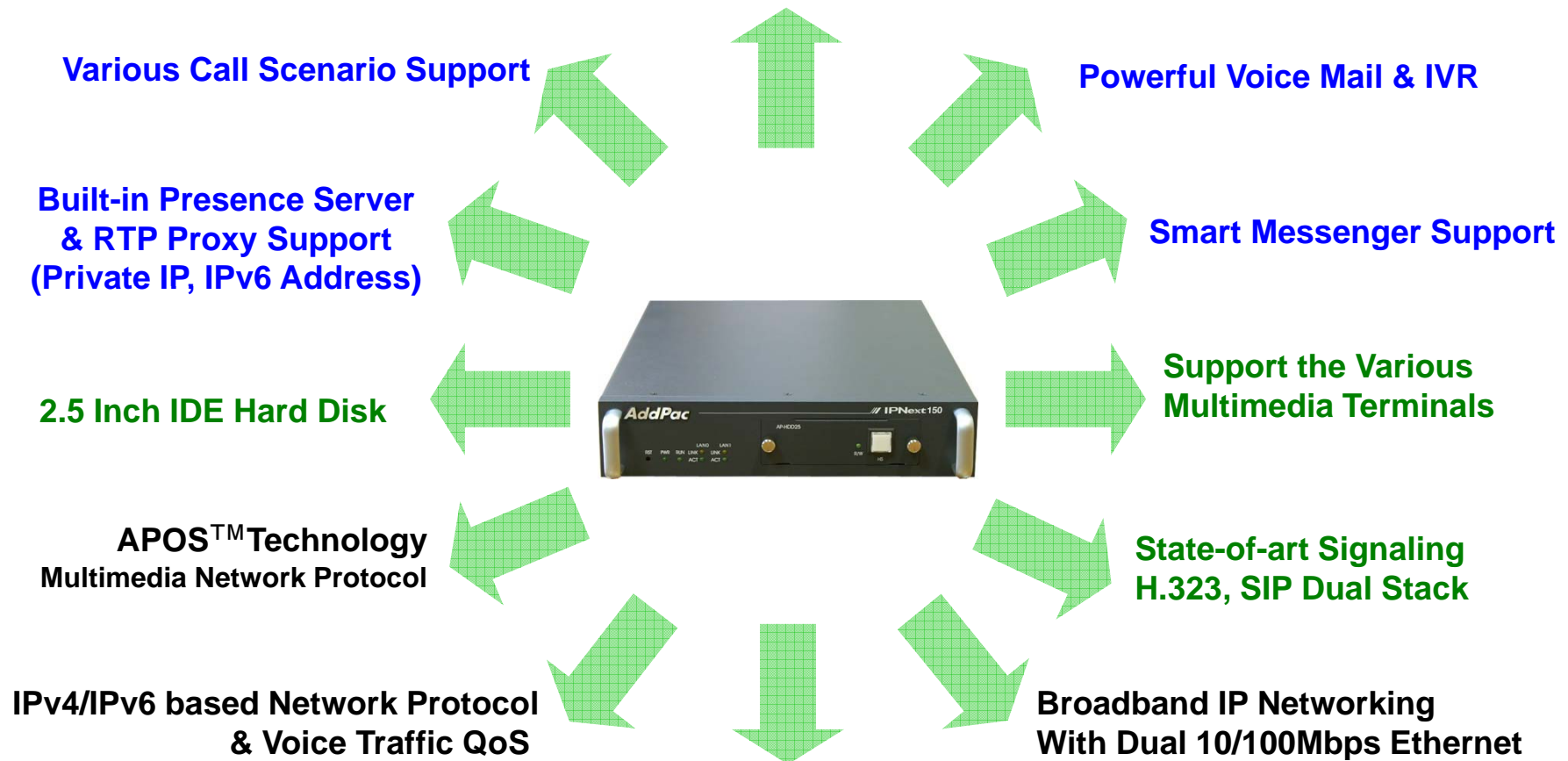

AddPac

www.addpac.com

Hardware Specification

IPNext150 Next Generation IP-PBX

RISC
CPU

- **RISC Microprocessor Computing Power**
- **Main Chassis**
 - **Network Interface**
 - Two(2) 10/100Mbps Fast Ethernet
 - One(1) RS-232C Console (RJ45)
 - **One(1) 2.5 Inch Hard Disk Interface Slot**



Hardware Specification

IPNext150 Next Generation IP-PBX



IPNext150 Front Side
Hard Disk Module



Read/Write Access LED Hot-Swap Switch & LAMP Indication

Hardware Specification

IPNext150 Next Generation IP-PBX

RISC
CPU

IPNext150 Rear Side

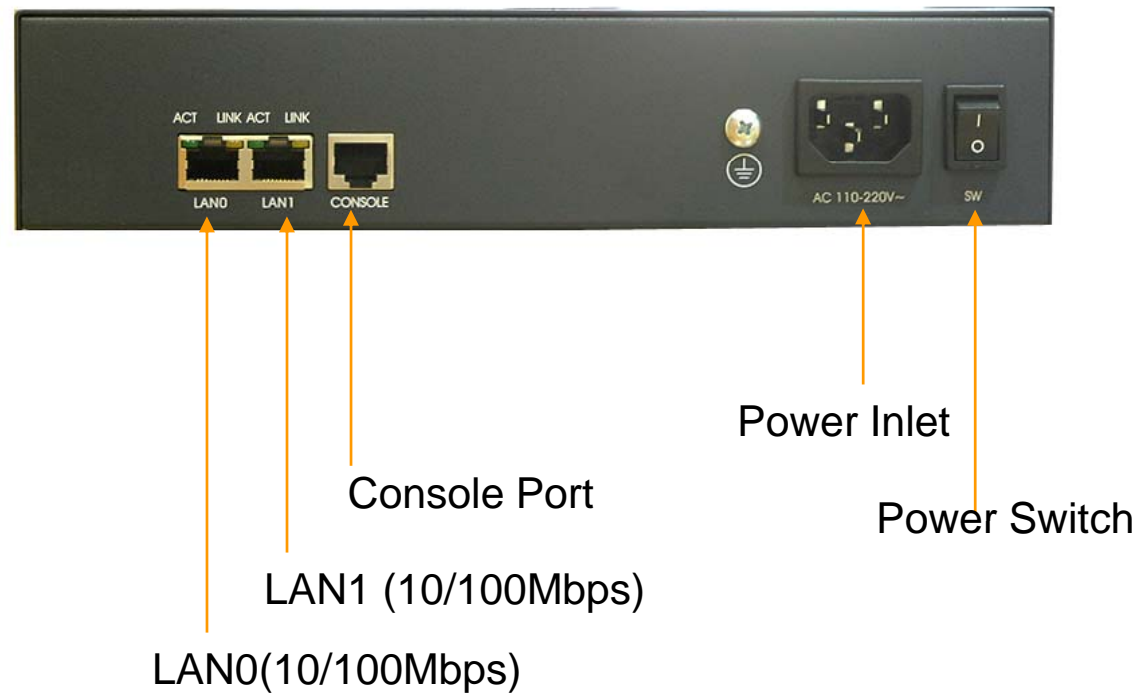

Software Service

IPNext150 Next Generation IP-PBX

- **Built-in AddPac APOS Internetworking Software**

- Scalability, Functionality, and Stability Features
- Advanced IP-PBX Call Manager Features
- QoS Control Features

- **Programmable Video, Audio, and Voice Services**

- Audio, and Voice Codec

- **Firmware Upgradeable Architecture**

- **Industry Standard Network Protocol Features**

- **Highly User Friendly Management Features**

- PC based Smart Messenger
- Smart Multimedia Manager for Operation & Management

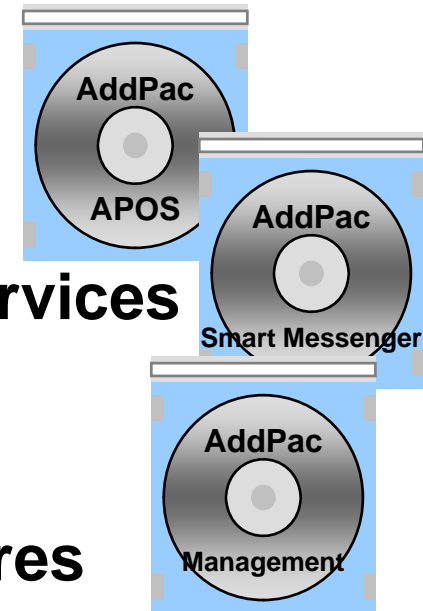

IP-PBX Software Components

IPNext150 Next Generation IP-PBX

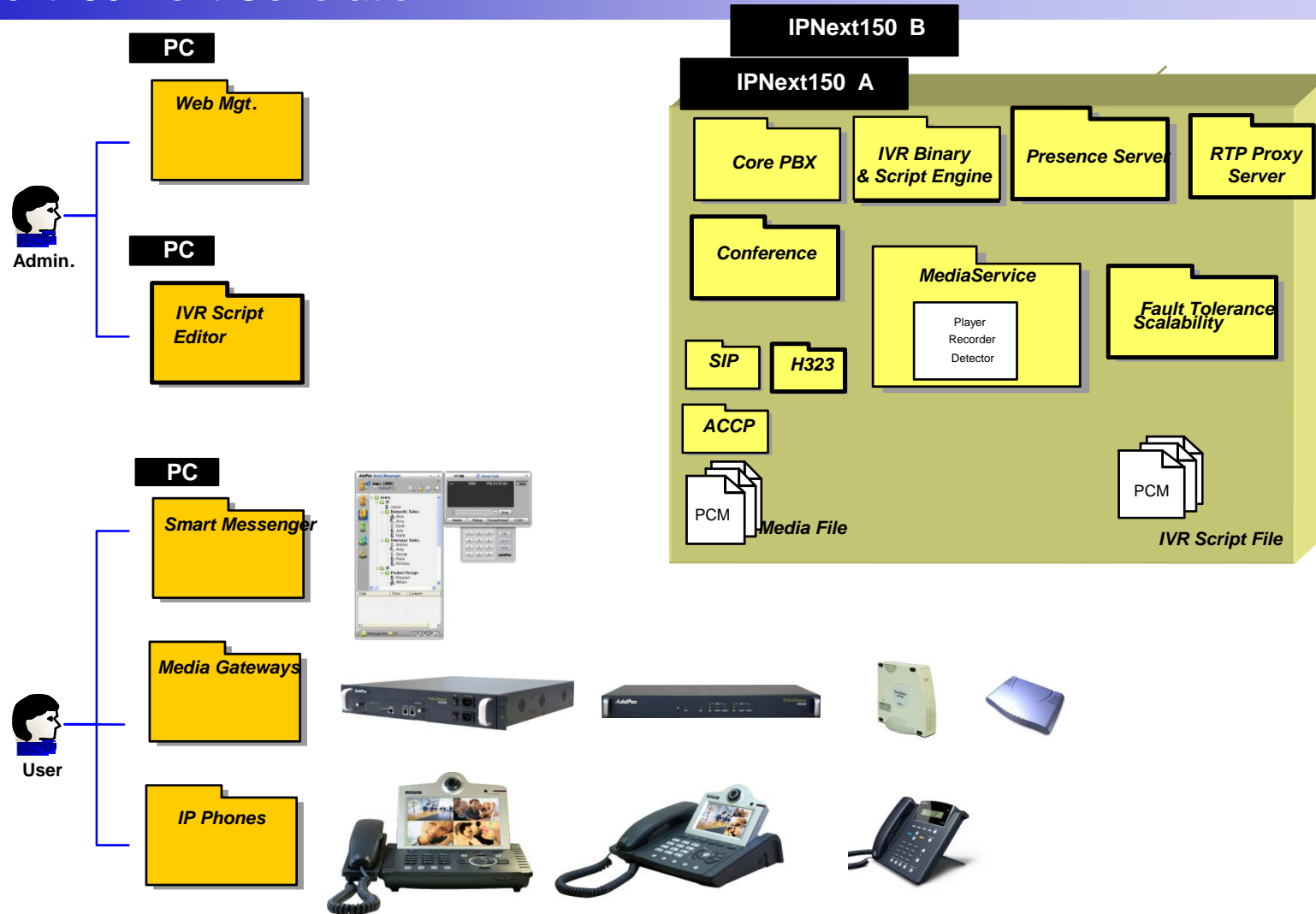

IP-PBX Features

IPNext150 Next Generation IP-PBX

- IP-PBX Advanced Features with AddPac IP, Video Phones
 - Multiple Call Handling with Call Status and Calling Line Number and Name
 - Plug and Play with Auto Discovery Function
 - Softkey Map Download and Control
 - Time and Date Setting
 - Voice Mail List View
 - Parked Call List View
 - Call Forward Setting
 - Recent Call List View
 - Calling Number and Name Identification
 - Individual Call Park within Park Number Pool by Softkey
 - Group Call Park within a Group or Other Group by Softkey
 - Call Pickup of Ringing Call of Same Group or Other Group by Softkey
 - Call Pickup of Parked Call by Softkey
 - Call Transfer - Blind, Consult by Softkey
 - Call Waiting Indication
 - Call Swapping by Softkey
 - Call Hold by SoftKey
 - Conference Control

IP-PBX Features

IPNext150 Next Generation IP-PBX

- User & Device Management
 - LDAP (Lightweight Directory Access Protocol) Support
 - Supports Hierarchical Organization
 - Auto Discovery of IP Phones & Video Phones
 - Monitoring Status of Phones
- Miscellaneous*
 - Distinctive Ring by Calling User
 - Auto Config & Upgrade
 - Intercom
 - Personal Directory
 - Downloadable Ring
 - Do not Disturb



Network Service and Features

IPNext150 Next Generation IP-PBX

Basic Network Protocols

- ARP, IP, IPv6, TCP, UDP, ICMP, ICMPv6, SCTP, IGMP, MLD

Routing Protocol

- IPv4 : Static
- IPv6 : Static

Service Protocol

- FTP, Telnet, TFTP, DHCP Server/Relay, SNMP Server
- CDP (Cisco Discovery Protocol)
- DNS Resolver , DDNS(nsupdate)
- Bridge
- Syslog
- IP/IPv6 policy control (QoS)
- VPDN (Virtual Private Dial-up Network : L2TP Server)

Network Service and Features

IPNext150 Next Generation IP-PBX

IPv4/IPv6 Interworking

- NAT/PAT for IPv4
- IP connect (formerly ip-share) and device cascade for IPv4
- IP/IP, IP/GRE tunneling
- NAT-PT
- 6to4, Autoconfig tunneling

IPv4 Address Configuration

- Fixed (Static)
- DHCP
- PPPoE

IPv6 Address Configuration

- Fixed (Static)
- EUI-64
- Autoconfig (Neighbor Advertisement and Solicitation)

Network Service and Features

IPNext150 Next Generation IP-PBX

Miscellaneous

- Cisco Style CLI
- Standard & Extended IPv4/IPv6 Access List
- Multi-level User Account Management
- IP accounting
- fsh (Embedded file system shell)
- STUN Client

Network Service and Features

IPNext150 Next Generation IP-PBX

SNMP MIBs

- MIB-II
- RMON MIBs (Statistics, History, Alarm, Hosts Group)
- RFC2465 Management Information Base for IP Version 6: Textual Conventions and General Group
- RFC2466 Management Information Base for IP Version 6: ICMPv6 Group
- RFC2452 IP Version 6 Management Information Base for the Transmission Control Protocol
- RFC2454 IP Version 6 Management Information Base for the User Datagram Protocol
- AddPac Enterprise MIBs
- etc

Smart Multimedia Manager

IPNext150 Next Generation IP-PBX

- Web based Smart and Easy Management Tool Support
- User, Device, Call, Conference Management with Intuitive User Interface
- Built in Event Manager or External Event Manager Support
 - Event Configuration with Event Source Filter and Event Logging Filter
 - Event Monitoring with Colorful Format
 - Debug Level Syslog Monitoring Support
 - Event Analysis by Smart Event Analyzer
- Active Call Monitoring Support
- Call Tracing Support
- Active Conference Monitoring Support
- Call History Viewer Support
- Backup, Restore and Initializing of Database Support
- Export and Import of Database to Excel File Support

IP Multimedia Terminals

IPNext150 Next Generation IP-PBX

- AP-VP500 Video Phone
- AP-VP350 MCU Video Phone
- AP-VP300 Video Phone
- AP-VP280 Video Phone
- AP-VP250 Video Phone
- AP-VP230 Video Phone
- AP-VP150 Video Phone
- AP-VP120 Video Phone
- AP-IP300 Premium IP Phone
- AP-IP250 IP Phone
- AP-IP160 IP Phone
- AP-IP120 IP Phone
- AP-IP90 IP Phone
- AP-WP100 WiFi Phone
- AP-SMP100 Soft Phone









AddPac

www.addpac.com

IP Video Phone Comparison Table

IPNext150 Next Generation IP-PBX

	AP-VP500	AP-VP350	AP-VP300N	AP-VP280	AP-VP250	AP-VP230	AP-VP150	AP-VP120
								
LCD Size	12.1 Inch Touch Screen	7Inch Touch Screen	7Inch Touch Screen	7Inch Touch Screen	4.3Inch Touch Screen	5Inch Touch Screen	4.3Inch Touch Screen	4.3Inch
Camera	CCD	CCD	CCD	CMOS	CMOS	CMOS	CCD	CMOS
Video Codec	H.263 MPEG4 H.264	H.263 MPEG4 H.264	H.263 MPEG4 H.264	H.263 MPEG4 H.264	H.263 MPEG4 H.264	H.263 MPEG4 H.264	H.263 MPEG4 H.264	H.263 MPEG4 H.264
Signaling	H.323/SIP	H.323/SIP	H.323/SIP	H.323/SIP	H.323/SIP	H.323/SIP	H.323/SIP	H.323/SIP
Video MCU	N/A	4-Party Video MCU	N/A	N/A	N/A	N/A	N/A	N/A
Voice MCU	3-Party	3-Party	3-Party	3-Party	3-Party	3-Party	3-Party	3-Party
LAN Port	2	2	2	2	2	2	2	2
PoE	N/A	N/A	Support	N/A	Support	Support	Support	Support

IP Phone Comparison Table

IPNext150 Next Generation IP-PBX

	AP-IP300	AP-IP250	AP-IP230	AP-IP160	AP-IP120	AP-IP90
						
LCD Size	4.3 Inch Color LCD	4.3 Inch Color LCD	5 Inch Color LCD	4 Text Line Graphic LCD	4 Text Line Graphic LCD	4 Text Line Graphic LCD
Touch Screen	N/A	Support	Support	N/A	N/A	N/A
Speed-Dial Keys	25 Key with Presence LED	Touch Screen based 25 Keys	Touch Screen based 25 Keys	16 Key with Presence LED	12 Key with Presence LED	N/A
Voice Codec	G.711/G.726/ G.729/G.723	G.711/G.726/ G.729/G.723	G.711/G.726/ G.729/G.723	G.711/G.726/ G.729/G.723	G.711/G.726/ G.729/G.723	G.711/G.726/ G.729/G.723
Signaling	H.323/SIP	H.323/SIP	H.323/SIP	H.323/SIP	H.323/SIP	H.323/SIP
3-Party Conversation	Support	Support	Support	Support	Support	Support
LAN Port	2	2	2	2	2	2
PoE(Optional)	Support	Support	Support	Support	Support	Support
FXO(Optional)	Support	Support	Support	Support	Support	Support

Smart Messenger

IPNext150 Next Generation IP-PBX

- Support Messenger Service
- Support Various Address Book
- Support User Presence Information
- Support User Search Feature
- Interoperation with Address Book and Smart Phone
- Support Smart Phone Control and Setup
 - Call Control and Forward Setup
- Support Unified Message Box
 - Voice Mail Box
 - Short Message Box



AP-VP300



AP-VP280

AddPac



IPNext150
IP-PBX

www.addpac.com



AddPac Smart Messenger

Standard IP-PBX Application

IPNext150 Next Generation IP-PBX

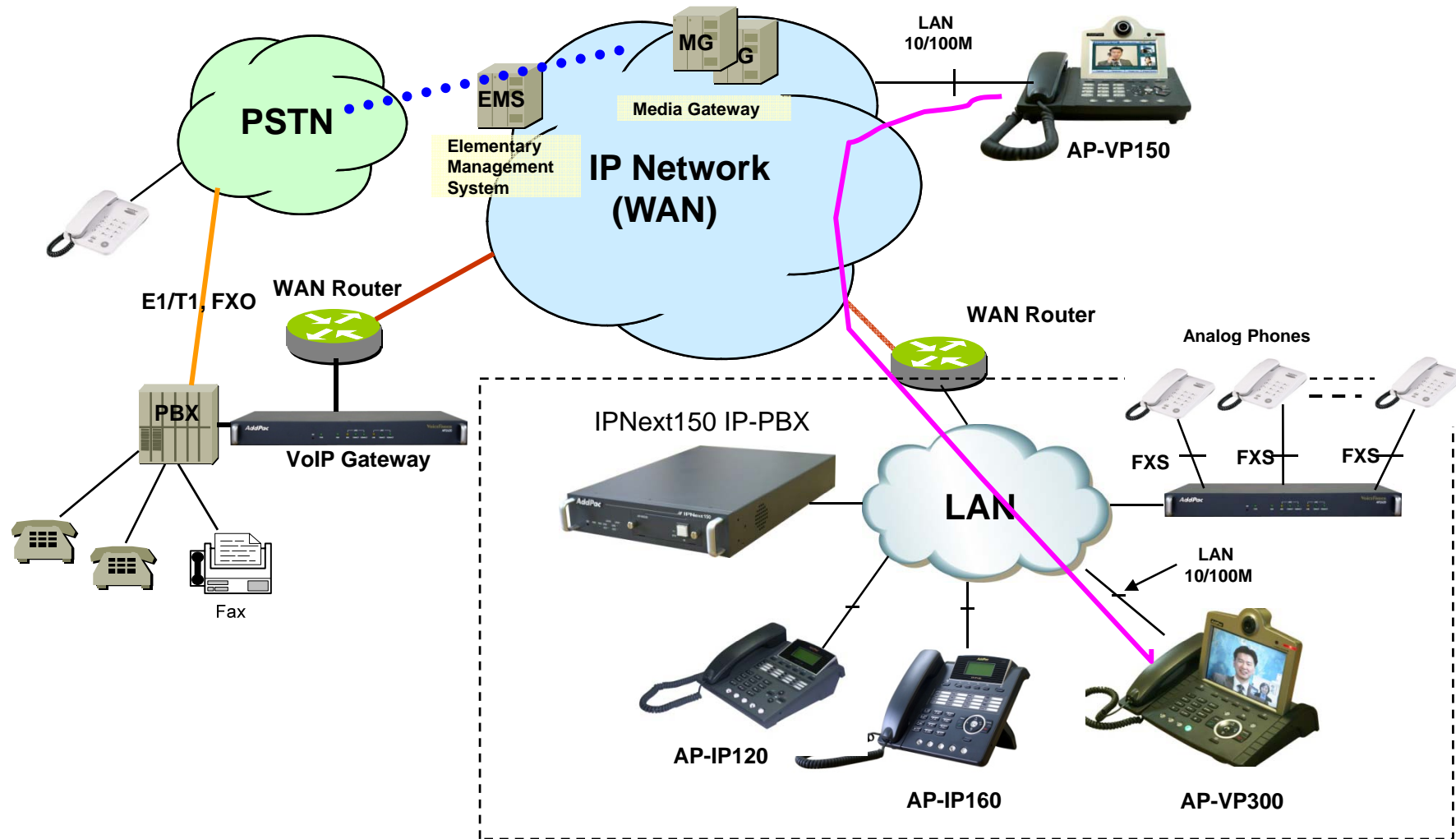

Ordering Information

- IPNext150 Next Generation IP-PBX Hardware
 - IPNext150 IP-PBX Main Body
 - High-performance 64bit RISC CPU
 - 2-ports 10/100Mbps Fast Ethernet and 1-port RS-232C Console
 - Including Network Cable Set & Ext. Power Supply, etc.
 - Hard Disk (2.5 Inch IDE 40Giga, Extendable)
- Built-in APOS Internetworking Software for IPNext150
- Including 1 Year Hardware Warranty
- Product Documents
 - Install and Operation Guide (PDF)
- Pricing
 - AddPac Technology Regional Sales Manager
 - Authorized Sales and Marketing Representatives
 - Please Contact www.addpac.com

IPNext 150 Next Generation IP-PBX

Thank you!

AddPac Technology Co., Ltd.
Sales and Marketing

Phone +82.2.568.3848 (KOREA)

FAX +82.2.568.3847 (KOREA)

E-mail sales@addpac.com