



# AP-NR1000™

## Network DVR Server

High-performance Network DVR Server Solution



# **AddPac**

**AddPac Technology**

2006, Sales and Marketing

# APOS Internetworking Protocol

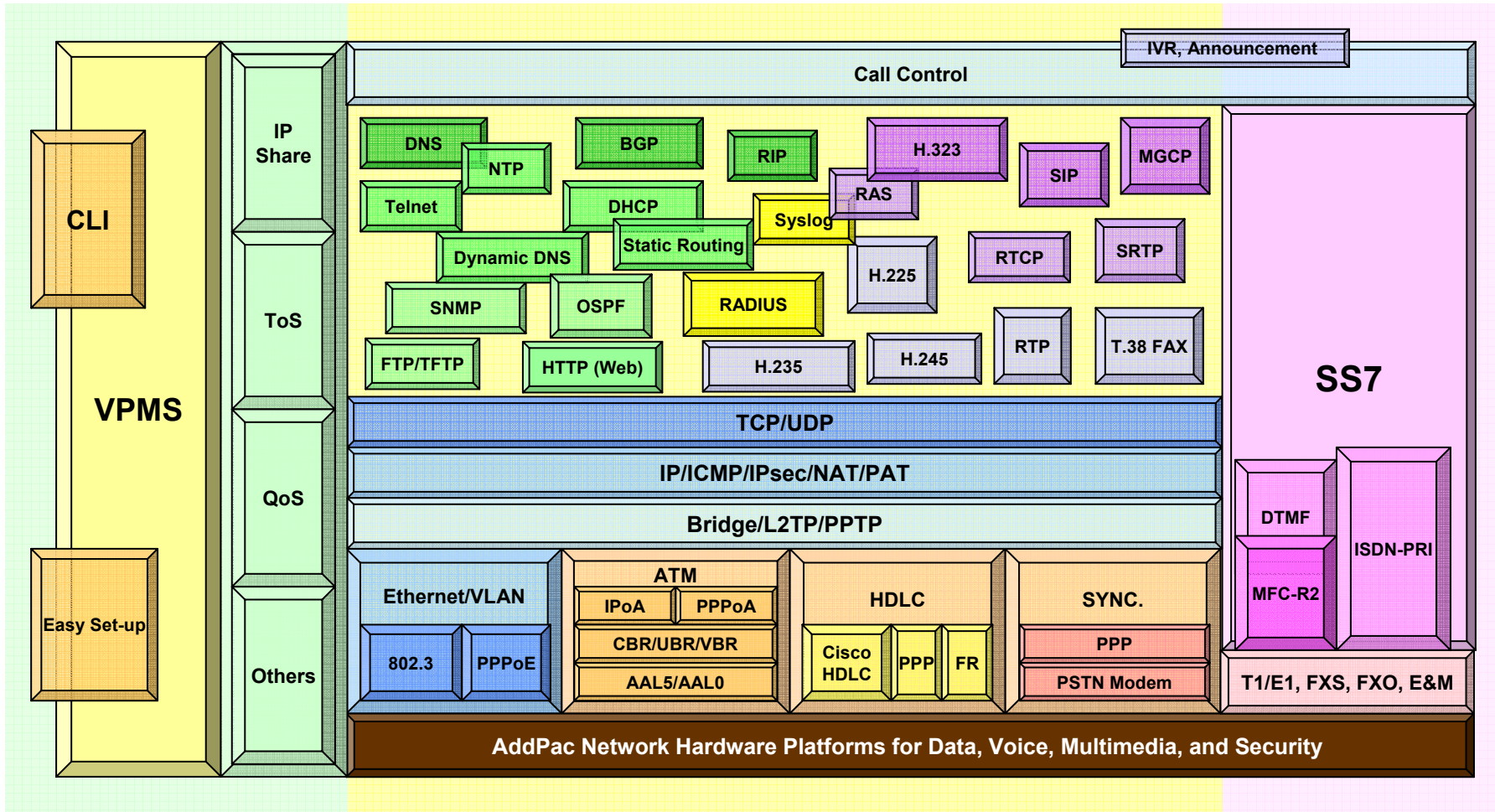

# AP-NR1000 Network DVR Server

- Product Overview
- Product Highlight
- Hardware Specification
- Software Service
- Network Service and Features
- Network DVR Components
- Application Service
- Ordering Information

# Product Overview

## AP-NR1000 Network DVR Server

- IP based Network DVR Server & Manager Server
- Powerful Management and User Friendly Features
- Fault Tolerant and Scalability Architecture
- High-performance Audio and Video Service
- Firmware Upgradeable Architecture
- Two(2) Gigabit Ethernet Interface
- **RAID 1** Hard Disk Backup



# Product Highlights

## AP-NR1000 Network DVR Server

Next Generation IP based  
Network DVR Server

Embedded System for Stability

Fault Tolerant and  
Scaleable Architecture

RAID 1 Hard Disk Backup  
(3.5 Inch IDE Hard Disk)

Four(4) Hard Disk Slots  
(Hot-Swap Support)

Firmware Upgradeable  
Architecture

Smart DVR Viewer

APOS™ Technology  
Multimedia Network Protocol

USB Host Mode Interface  
for Secondary Backup (DVD  
Writer), etc

High Performance Audio/Video  
Recording & Streaming Solution

Two(2) 10/100/1000Mbps  
Gigabit Ethernet

Smart DVR Manager for  
AP-NR1000 Management

**AddPac**

[www.addpac.com](http://www.addpac.com)



# Hardware Specification

AP-NR1000 Network DVR Server

64bit  
CPU

- **RISC Microprocessor Computing Power**
- **Main Chassis**
  - **Network Interface**
    - Two(2) 10/100/1000Mbps Gigabit Ethernet
    - One(1) RS-232C Console (RJ45)
  - **USB Host Mode Interface for DVD Backup, etc**
  - **Two(4) Hard Disk Interface Slot for RAID1 Configuration**



# Hardware Specification

## AP-NR1000 Network DVR Server

High-End  
RISC  
CPU

- Hard Disk Module (RAID 1)

AP-NR1000 Front Side

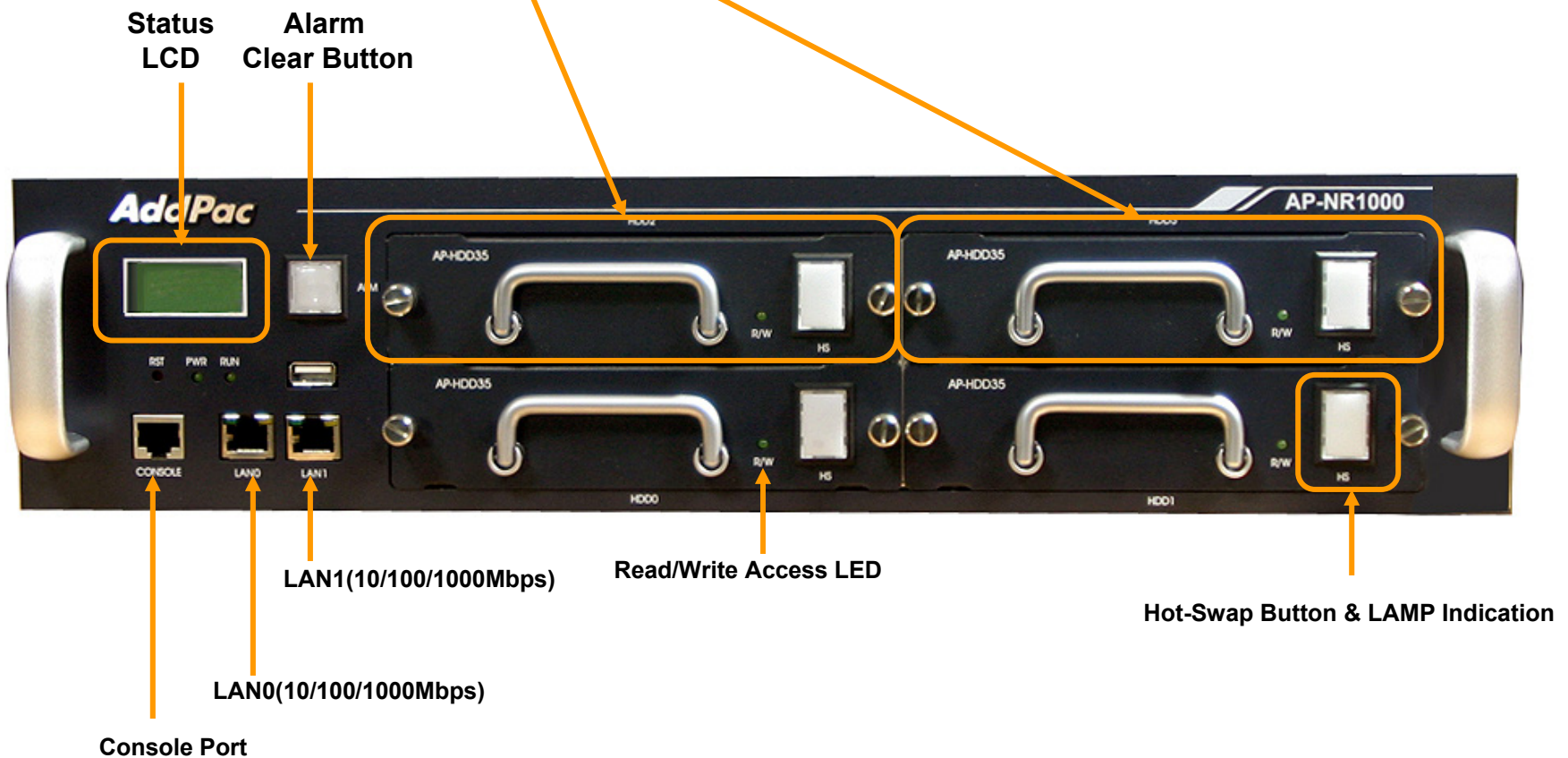

# Software Service

## AP-NR1000 Network DVR Server

- **Built-in AddPac APOS Internetworking Software**
  - Scalability, Functionality, and Stability Features
  - Advanced Network DVR Recording & Streaming Features
  - QoS Control Features
- **Firmware Upgradeable Architecture**
- **Industry Standard Network Protocol Features**
- **Highly User Friendly Management Features**
  - PC based Window Program
  - Smart DVR Manager

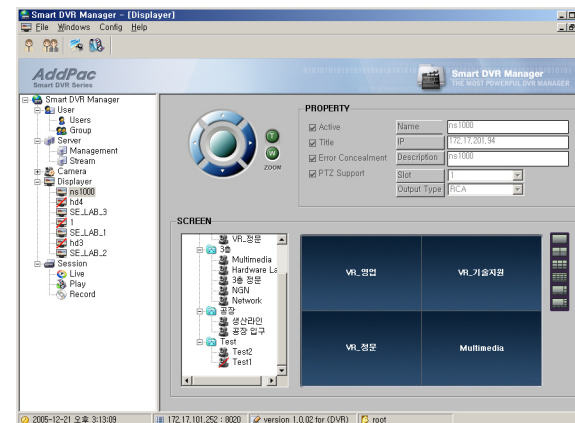
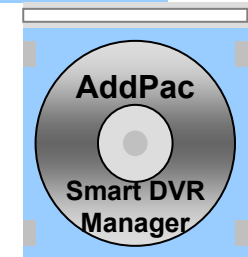
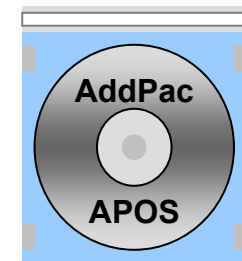



# Network Service and Features

## AP-NR1000 Network DVR Server

### Basic Network Protocols

- ARP, IPv4, TCP, UDP, ICMP, SCTP, IGMP, MLD

### Routing Protocol

- IPv4 : Static

### Service Protocol

- FTP, Telnet, TFTP, DHCP Server/Relay, SNMP Server
- CDP (Cisco Discovery Protocol)
- DNS Resolver , DDNS(nsupdate)
- Bridge
- Syslog

### IPv4 Address Configuration

- Fixed (Static)
- DHCP
- PPPoE

### Miscellaneous

- Standard & Extended IPv4 Access List
- Multi-level User Account Management
- IP accounting



# Network DVR Components

## AP-NR1000 Network DVR Server

- **Video Server**
  - AP-VS1000 (8CH)
  - AP-VS2000 (16CH)
- **Network Camera**
  - AP-NC700 (1-2CH)
  - AP-NC1000(1-2CH, Module, V.35 Router)
- **Live Displayer**
  - AP-VR1000 (1Slot)
  - AP-VR2000(2Slot)
  - AP-NS1000(4Slot)
- **DVR Streaming Server & DVR Manager Server**
  - AP-NR1000 (300Gx4Ea, Embedded, APOS)
  - AP-NR2000 (300Gx10Ea, Embedded, APOS)
  - AP-NR3000 (Dell Server, Linux)
  - AP-NR4000 (Dell Server, Linux)

# Network DVR Components

## AP-NR1000 Network DVR Server

- DVR Viewer
  - Smart DVR Viewer (Client, MS-Window)
  - Smart DVR Web Viewer for AP-NC series
  - Smart DVR Web Viewer + PC Storage for AP-NC series



# Live Displayer : AP-NS1000

## AP-NR1000 Network DVR Server

- Embedded Platform
- Network Camera Stream Real-time Decoding, Display
- RTP/RTSP Support
- RISC Microprocessor Computing Power
- High-end Programmable DSP Hardware Architecture
- Main Chassis
  - Two(2)10/100/1000Mbps Giga Ethernet
  - One(1) RS-232C Console (RJ45)
  - Two(2) HDD Interface Slot
  - Four(4) Video Interface Module Slot
- Video Module
  - AP-4TVD ( Four TV Display Interface Module)
  - AP-2TVD ( Two TV Display Interface Module)



# Live Displayer : AP-VR1000

## AP-NR1000 Network DVR Server

- **64bit RISC Microprocessor Computing Power**
- **Built-in High-end Programmable DSP Hardware Architecture**
- **Main Chassis**
  - **Network Interface**
    - Two(2) 10/100Mbps Fast Ethernet
    - One(1) RS-232C Console (RJ45)
- **Video Modules**
  - AP-AV1000 (RCA Type Support)
  - AP-AV1000C (Component Support)

### AP-AV1000 Video Module

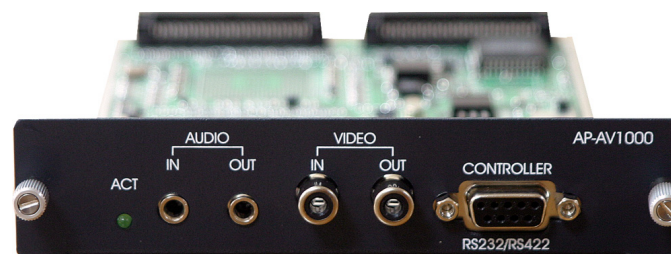

### AP-VR1000





# Network Camera : AP-NC1000

## AP-NR1000 Network DVR Server

- **RISC Microprocessor Computing Power**
- **High-end Programmable DSP Hardware Architecture**
- **Main Chassis : Network Interface**
  - One(1) 10/100Mbps Fast Ethernet
  - One(1) V.35 Interface (optional)
  - One(1) RS-232C Console (RJ45)
- **Video Module (AP-AV2000N)**
  - Powerful Video Interface
    - RCA (or BNC) Video Input
  - High quality Audio and Voice Interface
    - Stereo 3.5mm Audio Input Connector
  - Network Interface
    - One(1) RS-232C/RS422 Interface(DB-9) for Camera Control
- **Video Module (AP-AV2200N)**
  - Powerful Video Interface
    - RCA (or BNC) Video Input/Output
  - High quality Audio and Voice Interface
    - Stereo 3.5mm Audio Input/Output Connector
  - Network Interface
    - One(1) RS-232C/RS422 Interface(DB-9) for Camera Control
  - I/O Interface



# Network Camera : AP-NC700

## AP-NR1000 Network DVR Server

- **High Performance RISC Microprocessor Computing Power**
- **Built-in High-end Programmable DSP Hardware Architecture**
- **Network Interface**
  - One(1) 10/100Mbps Fast Ethernet
  - One(1) RS-232C Console (RJ45)
- **Powerful Video Interface**
  - RCA (or BNC) Video Input
- **High quality Audio and Voice Interface**
  - Stereo Audio Input/Output Connector
- **Camera Control Interface**
  - One(1) RS-232C/RS422 Interface for External Camera Control
- **I/O Interface**
  - 2 Alarm Input, 1 Relay



# Smart DVR Viewer

## AP-NR1000 Network DVR Server



- Multi-Network DVR Server Support
- PAN/TILT/ZOOM Control, Layout & Screen Mode Change
- Error Concealment Support
- Motion Detection & Tracking
- Multi-Live View, Multi-Recording View, Time Synchronization View
- Fast Search (up to 16 time), Jog Shuttle Slow Motion & Rewind
- Intelligent Search using Motion Detection
- Recording ZOOM View
- Audio/Video(MPEG4) Support.

# Application Service

AP-NR1000 Network DVR Server

- **Standard Network DVR Application**
- **Standard Network DVR Application + Multi-Screen TV Live Display**
- **Network DVR + IP Audio Broadcasting Application**

# Standard Network DVR App.

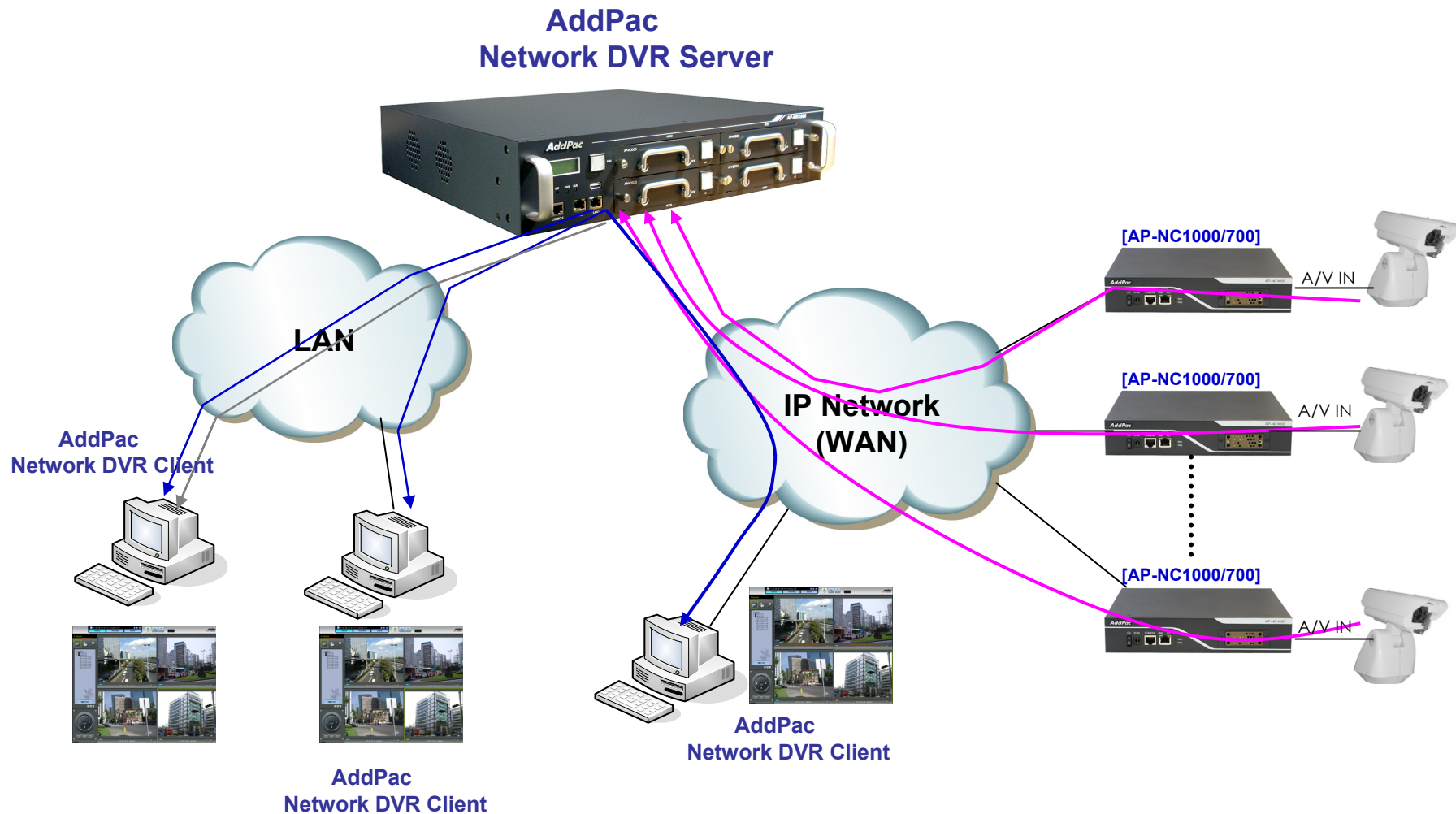



# Standard Network DVR App. + Live Display

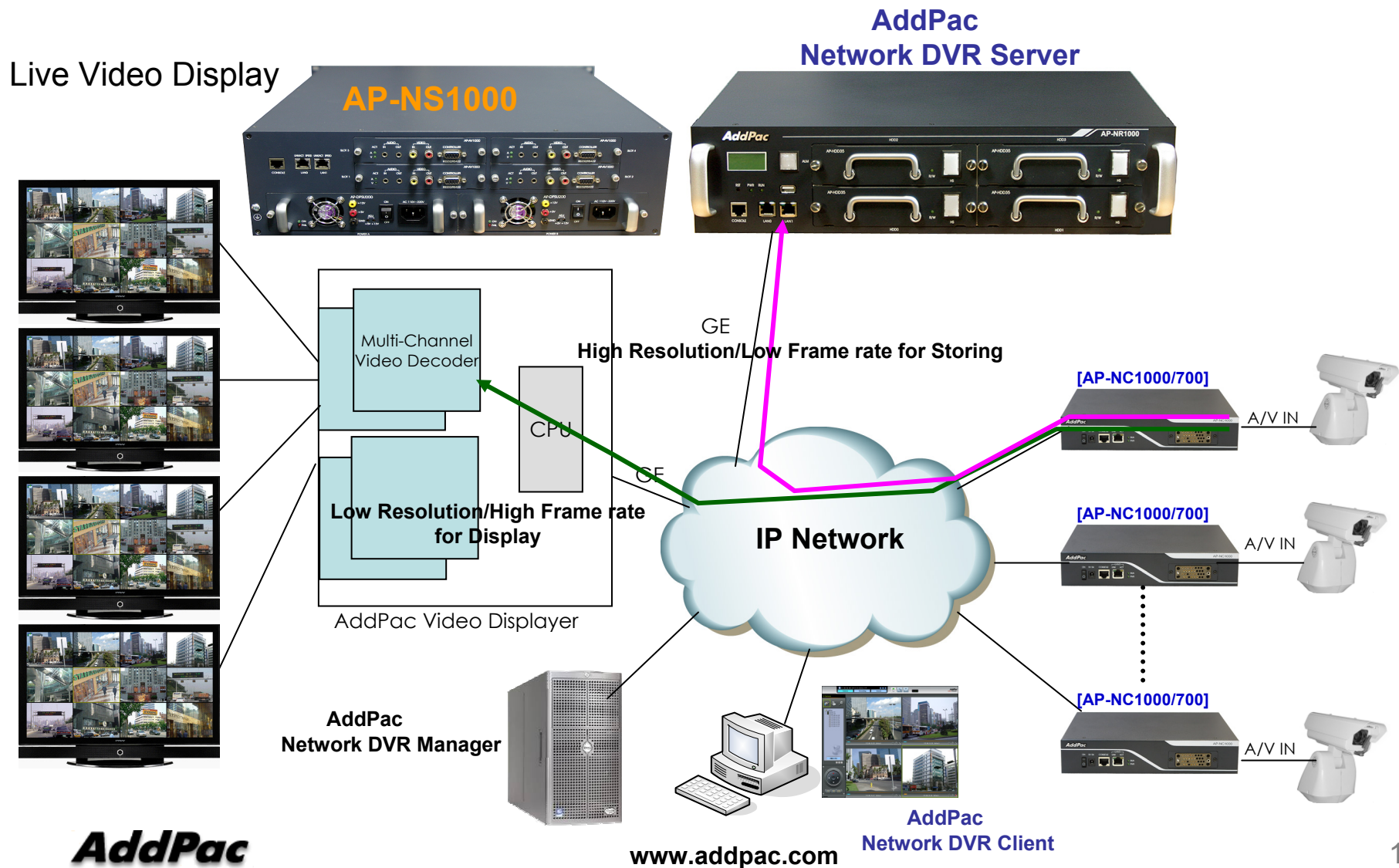

# Standard Network DVR App. + IP Audio Broadcasting

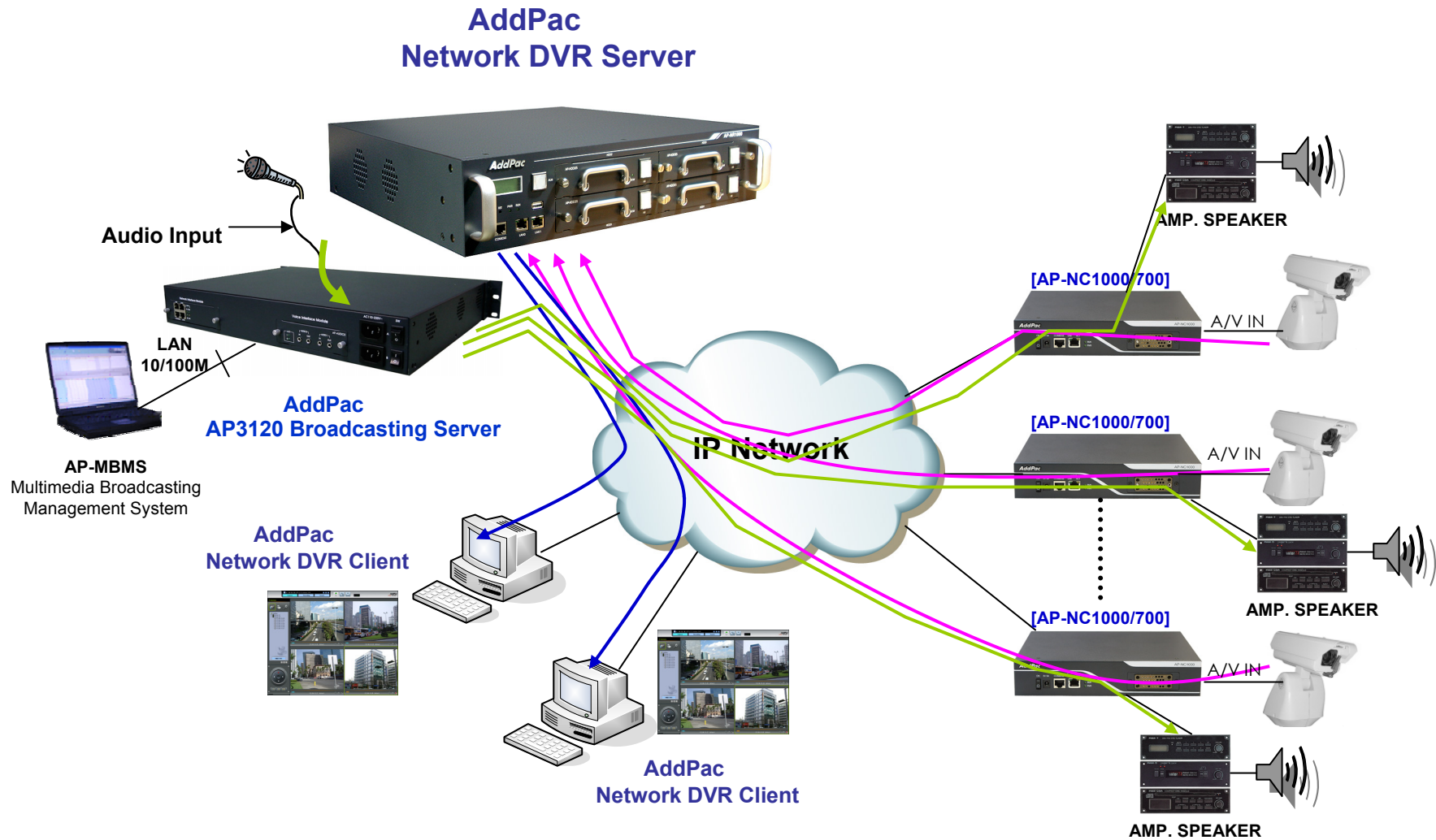

# Ordering Information

- **Network DVR Server AP-NR1000 Hardware**
  - AP-NR1000 Main Body
  - High-performance 64bit RISC CPU
  - 2-ports 10/100/1000Mbps Ethernet and 1-port RS-232C Console
  - 1-Port USB Interface
  - Including Network Cable Set & Power Supply Cable, etc.
  - RAID 1 Hard Disk (4x3.5 Inch IDE Type HDD, 250G Default)
- **Built-in APOS Internetworking Software for AP-NR1000**
- **Including 1 Year Hardware Warranty**
- **Product Documents**
  - Install and Operation Guide (PDF)
- **Pricing**
  - AddPac Technology Regional Sales Manager
  - Authorized Sales and Marketing Representatives
  - Please Contact [www.addpac.com](http://www.addpac.com)

# AP-NR1000™ Network DVR Server

Thank you!

**AddPac Technology Co., Ltd.**  
Sales and Marketing

Phone +82.2.568.3848 (KOREA)

FAX +82.2.568.3847 (KOREA)

E-mail [sales@addpac.com](mailto:sales@addpac.com)