VoiceFinder AP2620 VoIP Gateway Installation Guide

Release 1.00

May, 2005



AddPac Technology, Co. Ltd.

2nd fl., Jeong-Am Building., 769-12 Yoksam-dong

Kangnam-ku Seoul, Korea 135-080

Phone (82 2)568-3848

Fax (82 2)568-3847

E-mail : info@addpac.com

<http://www.addpac.com>

[Contents]

Getting into the VoiceFinder AP2620 User's Manual.....	5
Chapter 1. VoiceFinder AP2620 Overview	7
Introduction to the VoiceFinder AP2620.....	7
VoiceFinder AP2620 Gateway Overview.....	9
VoiceFinder AP2620 Gateway Hardware Specification.....	11
VoiceFinder AP2620 Gateway Support Protocol and Service	12
VoiceFinder AP2620 Gateway Front Part	14
VoiceFinder AP2620 Gateway Rear Part.....	16
Voice Processing Interface	17
Audio Processing Interface	21
Chapter 2. Before VoiceFinder AP2620 Installation	26
Installation Requirements.....	26
Electrical Requirements	26
General Requirements	28
Prerequisites for Network Connection.....	29
Unpacking.....	31
Chapter 3. VoiceFinder AP2620 Installation	33
Async Serial Interface Connection.....	33
Ethernet Interface Connection.....	34
Voice Interface Connection.....	35
E1 Interface Connection.....	36
Connection for AP2620 Interfaces	37
Chapter 4. Power Supply and Check Operational Status	38
AP2620 Gateway Booting and Operation	38
Use Console Terminal with HyperTerminal.....	39
Chapter 5. Appendix	45
Cable Specification.....	45

[Figures]

[Figure 1-1 Standard Network Diagram using AP2620 VoIP Gateway].....	7
[Figure 1-2 The Exterior of VoiceFinder AP2620 VoIP Gateway].....	8
[Figure 1-3 VoiceFinder AP2620 Front View]	14
[Figure 1-4 VoiceFinder AP2620 Rear View]	16
[Figure 1-5 AP-FXS4 card for AP2620]	18
[Figure 1-6 AP-FXO4 card for AP2620].....	18
[Figure 1-7 AP-FXS2O2 for AP2620].....	19
[Figure 1-8 AP-E&M4 card for AP2620].....	19
[Figure 1-9 APV1-1E1 card for AP2620]	20
[Figure 1-10 APV1-1T1 for AP2620]	20
[Figure 1-11 AP-AUDIO2 card for AP2620].....	22
[Figure 1-12 AP-AUD1S3 card for AP2620].....	22
[Figure 1-13 AP-AUD1O3 card for AP2620].....	23
[Figure 1-14 AP-AUD1S2O1 card for AP2620].....	23
[Figure 1-15 AP-MP3 card for AP2620]	24
[Figure 1-16 AP-HQA card for AP2620].....	24
[Figure 1-17 AP-AV500 card for AP2620]	25
[Figure 2-1 VoiceFinder AP2620 Package].....	31
[Figure 3-1 Connection between AP2620 Console Port and Terminal PC].....	33
[Figure 3-2 Connection between AP2620 LAN0/LAN1 and WAN equipment/PC]....	34
[Figure 3-3 Connection for VoiceFinder AP2620 Voice Interfaces]	35
[Figure 3-4 Connection for VoiceFinder AP2620 E1 Interfaces].....	36
[Figure 3-5 An Example of the Interface Connection].....	37
[Figure 4-1 MS-Windows Terminal Emulator - HyperTerminal]	39
[Figure 4-2 Assign a name for the new connection in HyperTerminal]	40
[Figure 4-3 Select the interface for Console cable]	41
[Figure 4-4 COM1 Port Configuration]	42
[Figure 4-5 The initial message of VoiceFinder AP2620 Gateway].....	44
[Figure 5-1 100Base-TX RJ-45 Connector]	46
[Figure 5-2 Digital E1/T1 RJ45 Pinout].....	47

< Tables >

<Table 1-1> VoiceFinder AP2620 Hardware Specification.....	11
<Table 1-2> VoiceFinder AP2620 Support Protocol and Service.....	12
<Table 1-3> The below table describes the front panel LED of AP2620 VoIP Gateway.....	14
<Table 1-4> VoiceFinder AP2620 Gateway Rear View Interface Description	16
<Table 5-1> The transferred signal and Pinout specification	45
<Table 5-2> Signal and Pinout of Direct Ethernet Cable	46

Getting into the VoiceFinder AP2620 User's Manual

This chapter provides the overview of the VoiceFinder AP2620 Gateway user's manual and an explanation of the symbols and legends involved.

[Composition of the Manual]

The VoiceFinder AP2620 installation guide serves to assist the installation of the AP2620 Gateway. This manual is composed of 4 chapters as the following.

Those experienced with Gateways may refer directly to the chapters as needed. But those less experienced are highly recommended to thoroughly understand the manual before operation of the Gateway.

- Chapter 1 「**VoiceFinder AP2620 Overview**」 provides an introduction to the hardware and software features of VoiceFinder AP2620 and technical support request method.
- Chapter 2 「**Before Installation**」 provides the installation environment and cable requirements, along with recommendations for safe operation of the equipment.
- Chapter 3 「**Installation**」 explains the basic installation information on connecting the gateway with cables, how to use Console terminal and etc.
- Chapter 4 「**Appendix**」 includes the specification of the gateway, the cable and etc.

For technical supports, please contact AddPac Technology Co. Ltd.

<p>AddPac Technology Co., Ltd 2nd Fl. Jeong-Am Building, 769-12 Phone (02) 568-3848 Fax (02) 568-3847 E-mail : info@addpac.com http://www.addpac.com</p>

The revision history of VoiceFinder AP2620 Gateway Installation Guide is as follows.

Revision No.	Date	Comments	Written by
Version 1.0	May 19, 2005	Initial Released	AddPac R&D Center

Chapter 1. VoiceFinder Overview

AP2620

Introduction to the VoiceFinder AP2620

VoiceFinder AP2620 VoIP Gateway is a next-generation VoIP Gateway delivering maximum 8 analog voice channels and up to 2 E1, 2 T1 voice channels to enterprises and public offices in a compact form factor. This new model realizes extended performance and higher adoptability by supporting various analog voice and digital E1, T1 modules.

Figure 1-1 : The network diagram using VoiceFinder AP2620 Gateway.

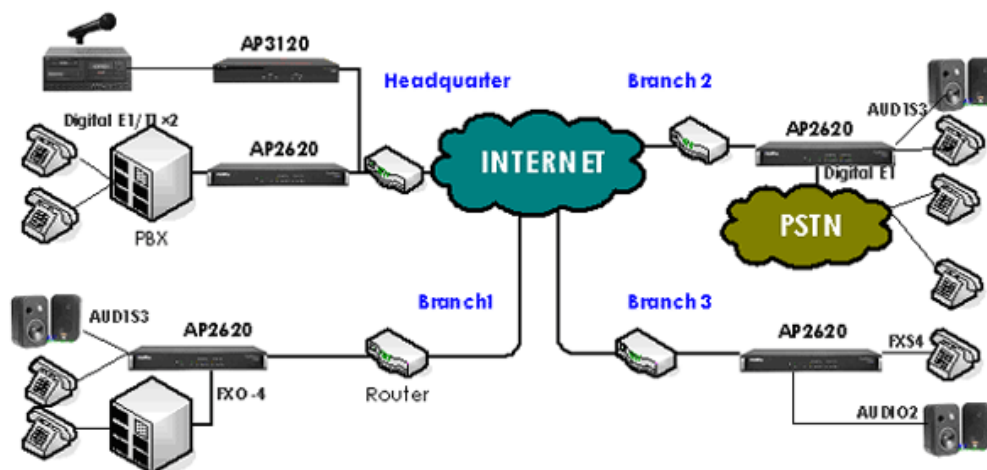

[Figure 1-1 Standard Network Diagram using AP2620 VoIP Gateway]

Most important part for VoIP telephony solution may be voice quality, cost effective advantage and interoperability. AP2620 VoIP provides the optimal solution to bring those features. It's standard compliant and market ready product, providing modular type architecture for high availability, analog voice and broadcasting modules such as FXS/FXO/E&M/MP3/Audio, unique advanced QoS algorithm, various IP based network protocol, concurrent support for H.323/SIP/MGCP. Besides, it ensures the seamless interoperability with major VoIP gatekeepers, SIP proxy servers, MGCs and PBXs. The exterior of AP2620 VoIP Gateway is provided in the following figure.



[Figure 1-2 The Exterior of VoiceFinder AP2620 VoIP Gateway]

Optionally, Packet Filtering and Access List type Firewall is supported, thus preventing intrusion using IP layer and TCP/UDP layer packet source and destination address information.

The DHCP(Dynamic Host Configuration Protocol) function automatically assigns IP addresses to lower level network clients, and uses NAT(Network Address Translation) to prevent IP address depletion while hiding internal IP addresses which also adds to the network security.

VoiceFinder AP2620 Gateway Overview

Your Choice of Cost Effective and Highly Adaptable System

With the rapid introduction of broadband WAN service, wide range of traditional telephony service is now migrating to a converged network. The customers are required to pay more close attention while introducing VoIP Gateway which stands at the very front line of IP network migration. The key is selecting cost effective and feature-proved products with high adaptability. AP2620 facilitates flexible and incremental service with its modular structure.

Small in Size, Big in Performance

AP2620 is a feature-rich VoIP Gateway supporting either maximum 8 channels of analog voice or 2 digital E1, T1 voice channels. That is, customers are able to enjoy the small capacity VoIP service by installing various analog VoIP modules at the initial stage and easily meet the port augmentation demands by replacing to E1, T1 modules. Along with the QoS ensured VoIP telephony service, AP2620 offers IP broadcasting terminal service by installing broadcasting modules such as [AP-AUDIO2](#). While saving investment, experience various VoIP/ BoIP services with its modular expansion options.

Supporting Two (2) 10/100Mbps Fast Ethernet Interface

AP2620 offers two (2) 10/100Mbps Fast Ethernet ports which ensure optimized VoIP service at NAT/PAT, VRRP and Router environment.

Enhanced QoS and Superior Scalability Services

AddPac's VoIP Gateway series have been highly appraised at both Koran and international markets and its lead in enterprise and carrier market reveals the advanced performance and stability. Moreover, AP2620 compares against competitive products in the market with its ample scalability services and AddPac's know-how which actively meet the communication needs of today's customers. In terms of VoIP call signaling protocol, AP2620 concurrently supports H323, SIP and MGCP signaling protocols. Not only general QoS algorithm, AP2620 supports the advanced QoS algorithms to maintain state-of-art voice quality on any types of conventional IP networks.

VoiceFinder AP2620 Gateway Hardware Specification

<Table 1-1> VoiceFinder AP2620 Hardware Specification

Microprocessor	PowerPC RISC Microprocessor	
Memory	Flash Memory	4Mbyte
	SDRAM Memory	32Mbyte High-Speed SDRAM
	Boot Memory	512Kbyte Flash Memory
Network Interface Module	Fixed LAN Port	Two(2) 10/100Mbps Fast Ethernet
	Console Port	One(1) RS-232C Interface
	Number of Slot	Two(2) Interface Slots
Voice Interface Module	AP-FXS4	4-Port FXS Voice Interface Module (4 x RJ11)
	AP-FXO4	4-Port FXO Voice Interface Module (4 x RJ11)
	AP-E&M4	4-Port E&M Voice Interface Module (4 x RJ11)
	AP-FXS2O2	2-FXO & 2-FXS Voice Interface Module (4 x RJ11)
	APV1-1E1	1-Port PBX Digital E1 Module (1 x RJ45)
	APV1-1T1	1-Port PBX Digital T1 Module (1 x RJ45)
	AP-AUDIO2	Audio Module(4 x 3.5mm Female)
	AP-AUD1S3	Audio/Voice Module(2 x 3.5mm Female/ 3 x RJ11)
	AP-AUD1S2O1	Audio/Voice Module(2 x 3.5mm Female/ 3 x RJ11)
	AP-AUD1O3	Audio/Voice Module(2 x 3.5mm Female/ 3 x RJ11)
	AP-MP3	High Quality Audio Module(4 x 3.5mm Female)
	AP-HQA	High Quality VoIP Audio Broadcasting Interface Module(2 x 3.5mm Female/ PSB)
Video Interface Module	AP-AV500	Video & Audio Encoder/Decoder Interface Module (2 x 3.5mm Female/ 2xRCA/ PSB)
Power Requirement	VAC 110~220V, 50/60Hz, 25Watt	
Operating Temp	0°C to + 50°C (32° to 122°F)	
Relative Humidity	5% to 95% (Non-condensing)	
Dimensions(H x W x D)	44 x 444 x 220(mm) - 19" Rack Mountable Chassis	
Weight(kg)	2.2Kg	

VoiceFinder AP2620 Gateway Support Protocol and Service

<Table 1-2> VoiceFinder AP2620 Support Protocol and Service

Routing Protocol	Static and IEEE 802.1Q VLAN Routing, RIP v1/v2, OSPF v2
WAN Protocol	Point-to-Point Protocol (PPPoE for ADSL), DHCP, Static IP
Voice over IP Services	H.323, SIP, and MGCP Triple Stack Support
	ISDN-PRI, R2, * DTMF Signaling Protocol Support
	ITU-T H.323 v3 VoIP Protocol with ITU-T H.235 Security Feature
	SIP protocol support compliant with IETF RFC3261 (or RFC2543)
	G.723.1, G726-16 K, G726-32K, G.729.A, G.711 Voice Compressions
	Voice Processing Features Supports - VAD, DRMF, CNG, G.168 and T.38 FAX Relay
	ITU-T H.323 Gateway, Gatekeeper Support
Network Management	Enhanced QoS Management Features for Voice Traffics
	Standard SNMP Agent (MIB v2) Support
	Traffic Queuing
	Remote Management using Console, Rlogin, Telnet
Security Functions	Web based Managements using HTTP Server Interface
	Standard & Extended IP Access List
	Access Control and Data Protections
	Enable/Disable for Specific Protocols
	Multi-Level User Account Management
	Auto-disconnect for Telnet/Console Sessions
	PPP User Authentication Supports → Password Authentication Protocol(PAP) → Challenge Handshake Authentication Protocol (CHAP)
Operation & Management	System Performance Analysis for Process, CPU
	Configuration Backup & Restore for APOS Managements
	Debugging, System Auditing, and Diagnostics Support

	System Booting and Auto-rebooting with Watchdog Feature
	System Managements with Data Logging
	IP Traffic Statistics with Accounting
Other Scalability Features	DHCP Server & Relay Functions
	Network Address Translation (NAT) Function
	Port Address Translation (PAT) Function
	Transparent Bridging (IEEE Standard) Function → Spanning Tree Bridging Protocol Support → Remote Bridging Support → Concurrent Routing and Bridging Support
	Easy Command Line Interface (CLI)
	Network time Protocol(NTP) Support

VoiceFinder AP2620 Gateway Front Part

On the front panel of AP2620 VoIP Gateway, various LEDs are placed for easy operation monitoring along with Max. two(2) channels of FXS, FXO, and E&M Voice interfaces, 2 Ethernet, Console ports making possible WAN-to-LAN VoIP service and IP routing service

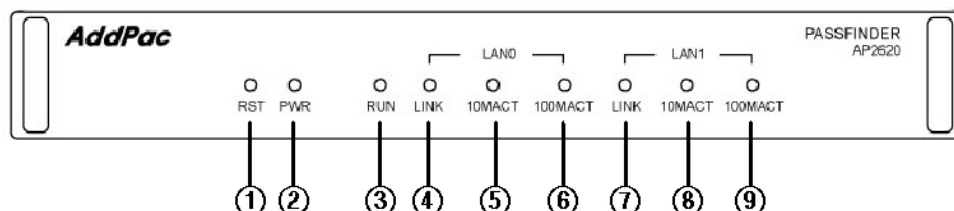

[Figure 1-3 VoiceFinder AP2620 Front View]

<Table 1-3> The below table describes the front panel LED of AP2620 VoIP Gateway

No.	Part	Description
①	RST	RESET switch : Resets the system by hardware (Red)
②	PWR	Power LED : Indicates power supply (Green)
③	RUN	RUN LED : Indicates proper functioning of the equipment (ACT Green)
④	LAN0 Link	LINK LED : Indicates proper connection of LAN0 (Yellow)
⑤	LAN0 10M ACT	LAN0 10M LED : Indicates Ethernet port data input status(ACT Green)
⑥	LAN0 100M ACT	LAN0 100M LED : Indicates Ethernet port data input status(ACT Green)
⑦	LAN1 Link	LINK1 LED : Indicates proper connection of LAN0(Yellow)
⑧	LAN1 10M ACT	LAN1 10M LED : Indicates Ethernet port

		data input status(ACT Green)
⑨	LAN1 100M ACT	LAN1 100M LED : Indicates Ethernet port data input status(ACT Green)

VoiceFinder AP2620 Gateway Rear Part

AP2620 VoIP Gateway's rear view adapts external architecture for user friendly cable and power switch working.

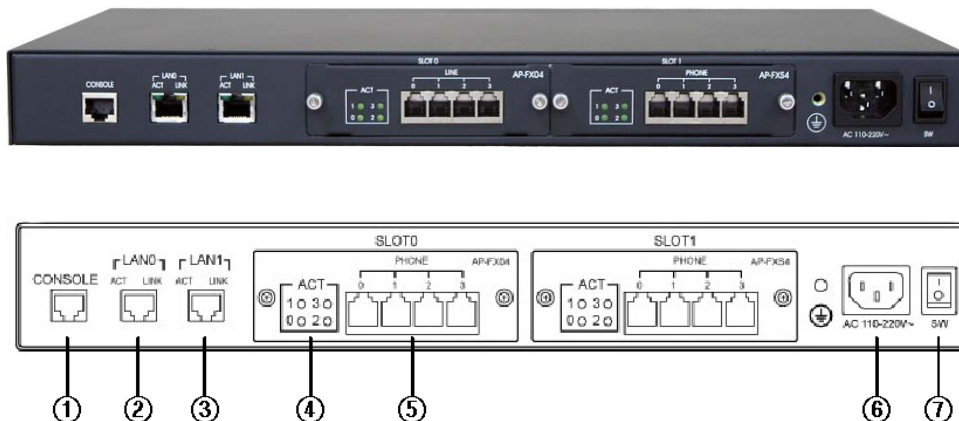

[Figure 1-4 VoiceFinder AP2620 Rear View]

<Table 1-4> VoiceFinder AP2620 Gateway Rear View Interface Description

No.	Label	Description
①	CONSOLE	With the provided console cable, connect with the PC for equipment configuration. Mandatory for initial setting.
②	LAN0	RJ45/LAN0 Ethernet Interface.
③	LAN1	RJ45/LAN1 Ethernet Interface.
④	ACT 0/1/2/3	Indicates Voice Port status (ACT Green)
⑤	PHONE	RJ11/FXS Interface.
⑥	AC 110~220V	Connects power cable. The AP2620 VoIP Gateway uses both 110 and 220V AC .
⑦	SW	Switch for power supply.

Voice Processing Interface

The multi-service network modules of AP2620 VoIP Gateway are optional and can be selected according to users' network. Multi-service network modules for high quality multimedia solution can be divided as follows.

- **FXS interface voice module**
- **FXO interface voice module**
- **FXS2O2 interface voice module**
- **E&M interface voice module**
- **Digital E1/T1 interface voice module**

4-Port FXS Voice Interface Module

AP2620 VoIP Gateway offers 4 channel Foreign Exchange Station (FXS) to connect ordinary telephones and PBX directly.

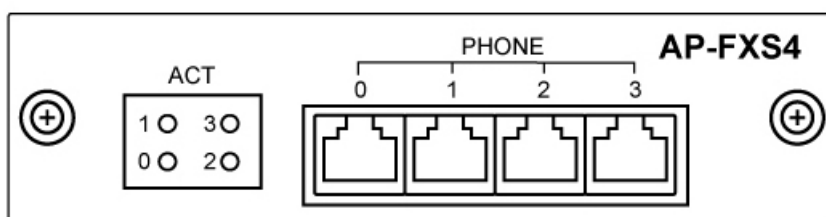

[Figure 1-5 AP-FXS4 card for AP2620]

4-Port FXO Voice Interface Module

AP2620 VoIP Gateway offers 4 channel Foreign Exchange Office (FXO) to connect the switching office of Public Switched Telephone Network (PSTN) or ordinary telephones.

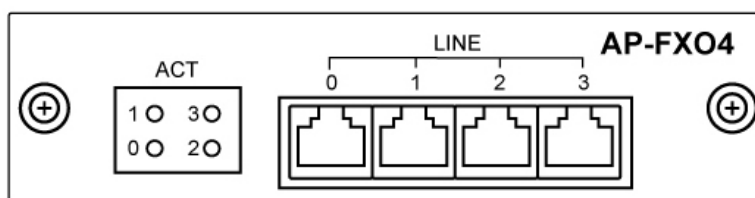

[Figure 1-6 AP-FXO4 card for AP2620]

4-Port-FXO2S2 : 2-Port FXO and 2-Port FXS Voice Interface Module

4-port-FXO2S2 offers various voice service with 2- channel FXS voice interface and 2- channel FXO interface in one module.

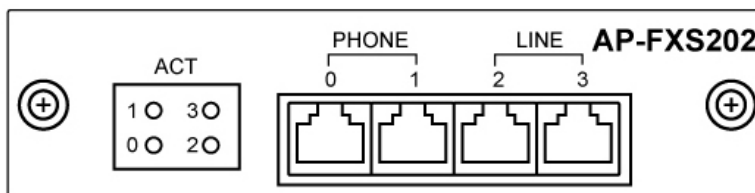

[Figure 1-7 AP-FXS202 for AP2620]

4-Port E&M Voice Interface Module

AP2620 VoIP Gateway supports 4 channel voice service module of receive and transmit (E&M). This analog E&M Interface is used to connect Trunk line of PBX.

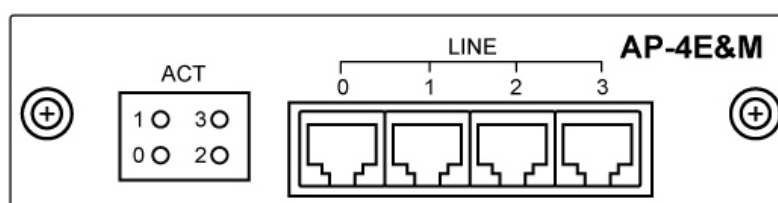

[Figure 1-8 AP-E&M4 card for AP2620]

Digital E1 Voice Interface Module

VoiceFinder AP2620 VoIP Gateway support digital E1 voice processing module for PBX interworking. Digital E1 Interface module supports ISDN-PRI, MFC-R2, DTMF and accommodate maximum 30

voice channels.

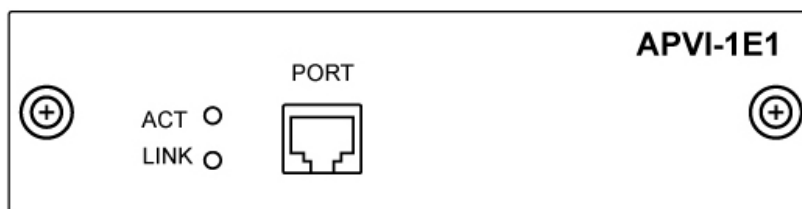

[Figure 1-9 APV1-1E1 card for AP2620]

Digital T1 Voice Interface Module

VoiceFinder AP2620 VoIP Gateway supports digital T1 voice processing module for PBX interworking. Digital T1 Interface module supports ISDN-PRI, MFC-R2, DTMF and accommodate maximum 23 voice channels.

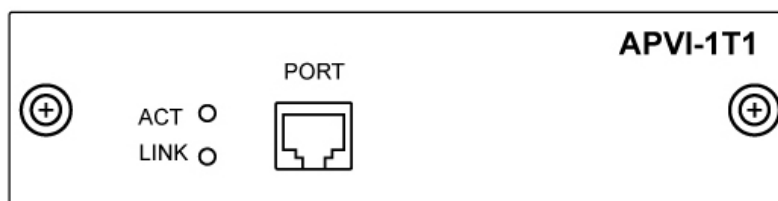

[Figure 1-10 APV1-1T1 for AP2620]

Audio Processing Interface

Audio processing interfaces for VoIP Broadcasting System solution can be divided as follows

- **Audio interface voice processing module**
- **Audio interface, FXS interface voice processing module**
- **Audio interface, FXO interface voice processing module**
- **Audio interface, FXS interface, FXO interface voice processing module**
- **MP3 interface voice processing module**
- **HQA Audio Module**
- **Audio&Video Encoder/Decoder Module**

2-Channel Audio Broadcasting Module

VoiceFinder AP2620 VoIP Gateway supports standard Audio processing module. AP-Audio2 standard broadcasting module supports 2-channel Audio In/Out using high performance DSP for VoIP broadcasting service.

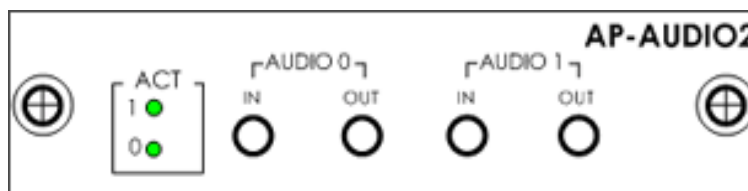

[Figure 1-11 AP-AUDIO2 card for AP2620]

1-Channel Audio, 3-Port FXS Module

VoiceFinder AP2620 VoIP Gateway supports high performance audio/voice integrated module. AP-AUD1S3 broadcasting module supports 1-channel Audio In/Out and 3-FXS ports for VoIP broadcasting service and VoIP call.

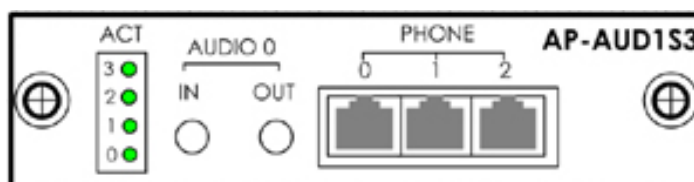

[Figure 1-12 AP-AUD1S3 card for AP2620]

1-Channel Audio, 3-Port FXO Module

VoiceFinder AP2620 VoIP Gateway supports high performance audio/voice integrated module. AP-AUD1S3 broadcasting module supports 1-channel Audio In/Out and 3-FXO ports for VoIP broadcasting service and VoIP call.

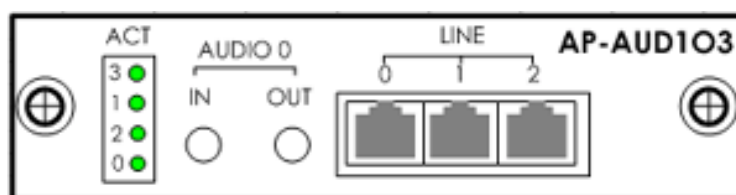

[Figure 1-13 AP-AUD1O3 card for AP2620]

1-Channel Audio, 2-Port FXS, 1-Port FXO Module

VoiceFinder AP2620 VoIP Gateway supports high performance audio/voice integrated module. AP-AUD1S2O1 broadcasting module supports 1-channel Audio In/Out, 2-FXS ports, 1-FXO port for VoIP broadcasting service and VoIP call.

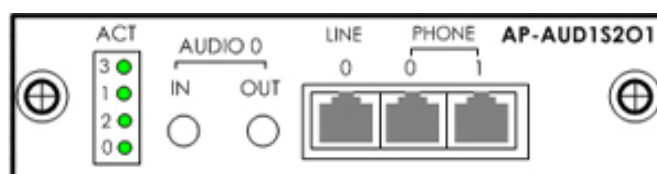

[Figure 1-14 AP-AUD1S2O1 card for AP2620]

1-Channel MP3 Audio Module

VoiceFinder AP2620 VoIP Gateway supports high performance MP3 broadcasting module for high quality music broadcasting service. AP-MP3 broadcasting module features 1-channel MP3 In/Out for high quality VoIP broadcasting service. User can use MIC and Line-in as Input channels and Headphone and Line-out as output channels.

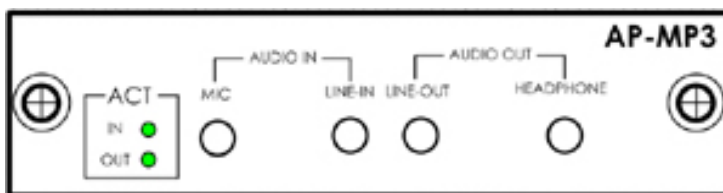

[Figure 1-15 AP-MP3 card for AP2620]

1-Channel HQA Audio Module

VoiceFinder AP2620 VoIP Gateway supports high performance HQA broadcasting module for providing high quality music broadcasting service. AP-HQA broadcasting module offers high quality VoIP broadcasting service using 1-channel Audio In/Out. User can use MIC and Line-in as Input channels and Headphone and Line-out as output channels. Built-in PSB relay port also enables remote On/Off power switching of Audio Amp.

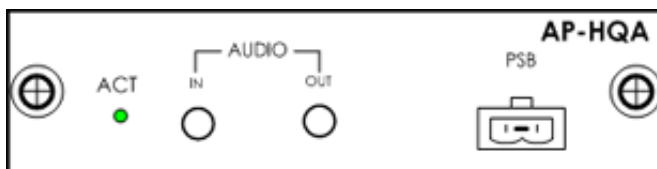

[Figure 1-16 AP-HQA card for AP2620]

1-Channel Audio&Video Encoder/Decoder Module

VoiceFinder AP2620 VoIP Gateway supports high performance video & audio encoding/decoding interface module. AP-AV500 broadcasting module provides high quality AV broadcasting service using 1-channel Audio, Video In/Out. User can use MIC/Line-in as audio input channels, DVD/TV/Camera as video input channels. Line-out/Headphone as video input channels, and TV/Monitor as video output channels. Built-in PSB relay port also enables remote On/Off power switching of Audio Amp.

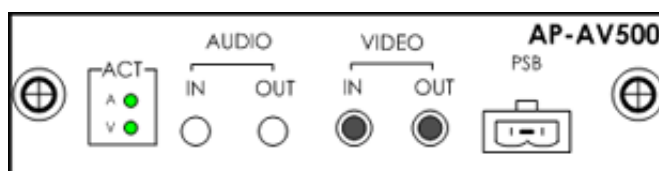

[Figure 1-17 AP-AV500 card for AP2620]

Chapter 2. Before VoiceFinder AP2620 Installation

Installation Requirements

The following is the recommendation for safe operation of the equipment.

- Ensure the AP2620 VoIP Gateway is in a dust-free environment before and after installation.
- Ensure the AP2620 cover is opened on a flat and safe surface.
- To prevent accidents, avoid ties, scarf, sleeves, and any other loose clothing from entangling with the Chassis.
- Avoid any actions that may effect the equipment or the operator.

Electrical Requirements

There are two main sources of electrical problems with the AP2620 : the power supply and static electricity.

This section describes safety recommendations for each case.

- **Electrical Safety**
 - ✓ In case of the occurrence of an electrical accident, operate at a position where immediate shut-off of power supply is possible.
 - ✓ Switch the power off when installing or taking the cover off the equipment.

- ✓ Avoid operating the equipment alone at a potentially dangerous environment.
- ✓ Do not assume the power is switched off, but always confirm the power status.
- ✓ Be extremely cautious when operating in a humid environment or with an uncovered power extension cable.

- **Prevention of Static Electricity**
 - ✓ The main chip-set of the Gateway are very delicate and misuse may result in static electrical damage.
 - ✓ If a static prevention waist strap is available, strap it around the wrist and earth the cord before operating the equipment.
 - ✓ If no waist tap is available, earthing by holding a metal part of the Chassis will help prevent static electricity.

General Requirements

The VoiceFinder AP2620 is ready for use where electronic products are used. However, a location with the following conditions are recommended for maximum performance.

- **A level and well ventilated location is recommended.**
- **Secure the equipment safely where intended to install.**
- **Avoid placing objects on top of the equipment.**
- **Install the equipment in a cool location avoiding direct sunlight.**
- **Maintain distance from flammable, chemical, or magnetic objects.**

Prerequisites for Network Connection

Observe EIA standards and distance limitations when installing the Gateway

The following section describes the synchronous serial cable, Ethernet Cable and the Console Cable VoiceFinder AP2620 supports.

Preparation for Installation

Unless ordered in advance, the tools and certain cables are not provided in the package. Prepare the following equipments and tools before the installation.

- Standard screwdriver set

- Cable for LAN and serial port
 - ✓ RJ-45 to RJ-45 cable for LAN port
 - ✓ RS-232c console cable with RJ-45 connector (included in the package)

- Cable for Phone port
 - ✓ Telephone line with RJ-11 connector

- PC with Console Terminal or Communication Emulator application (The Hyper Terminal Program in Windows will suffice. Configure it as : 9,600 Baud, No Parity, 8Bit Data 1Stop Bit)

Ethernet Port

AP2620 VoIP Gateway has two(2) RJ45 type Ethernet Ports and LEDs of the ports on the front panel. Make sure to use specified cable and connectors to use the ports.

RS-232C Serial Console Port

AP2620 VoIP Gateway has RJ-45 type RS-232C Female DCE connector interface on the front panel. This port is used for Initial Configuration, monitoring and debugging of the Gateway. Make sure to use specified cable and connectors to use the port.

Unpacking

Before unpacking, check for external damage of the packaging box .

If an external damage of the packaging has been found, please contact AddPac Technology Co. Ltd. sales department (sales@addpac.com, tel : +82-2-568-3848) for an immediate exchange of product.

If no external damage has found, confirm if the following items are enclosed.

No.	Item	Contents	Q'ty
1	VoiceFinder AP2620 Gateway Main Body		1
2	LAN Cable (For RJ45 to RJ45)		1
3	Console Port Cable (For RJ45 to DB9)		1
4	AC Power Cable (220V)		1

[Figure 2-1 VoiceFinder AP2620 Package]

Chapter 3. VoiceFinder Installation

AP2620

Async Serial Interface Connection

- Connect the console port in the rear side of the Gateway with the serial port of the prepared console terminal. **(Refer to [Figure 3.1])** Use the console cable provided with the package. If using a PC as the console terminal, connect to the Ethernet port of the PC.

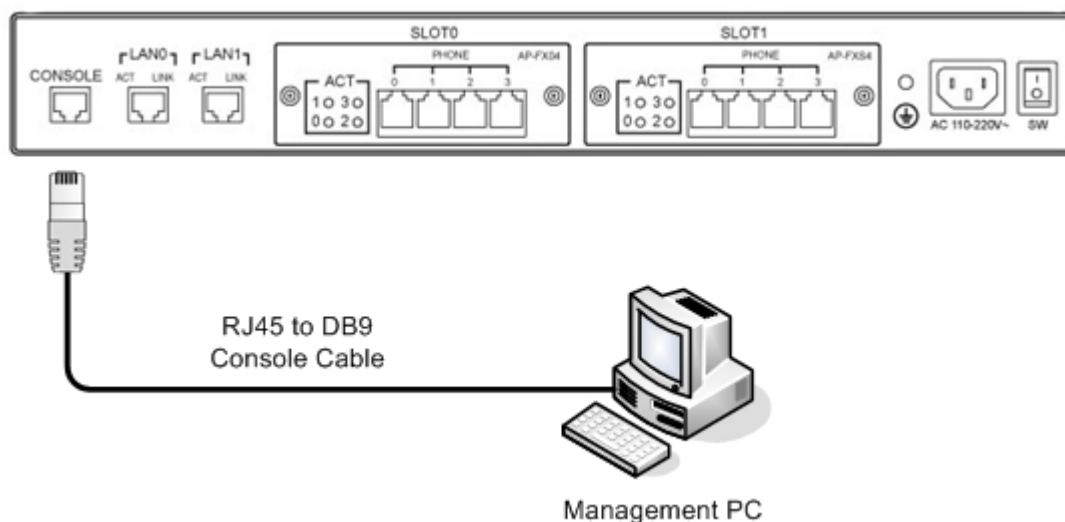

[Figure 3-1 Connection between AP2620 Console Port and Terminal PC]

Ethernet Interface Connection

- Connect the network to the desired port using RJ-45 connector. Below figure shows a network config with LAN0 for WAN, LAN1 for PC.

Failure : WAN Cable is connected to console

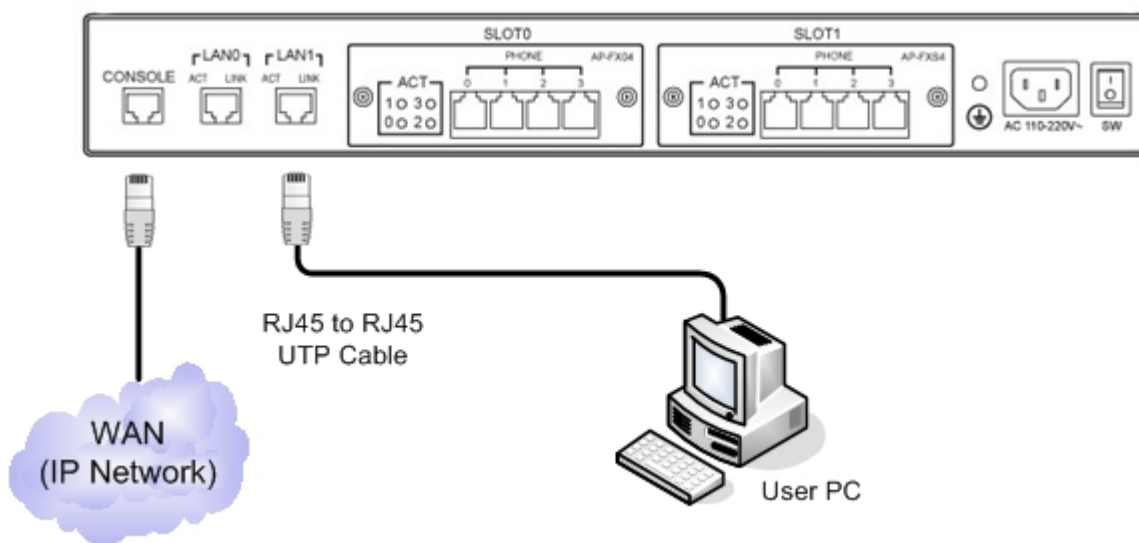

[Figure 3-2 Connection between AP2620 LAN0/LAN1 and WAN equipment/PC]

Voice Interface Connection

FXS/FXO port can be connected to proper equipment using RJ-11 connector. Usually FXS is connected to subscribers' handset and FXO is connected to PBX extension. Because E&M port has a different PIN array, please check the cable specification at 4th chapter Appendix.

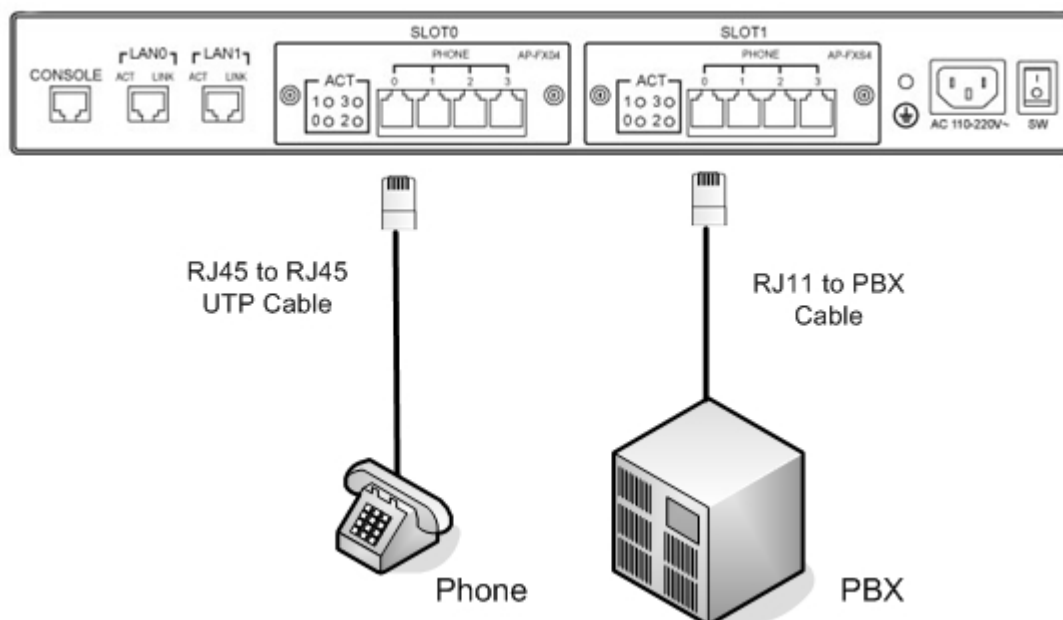

[Figure 3-3 Connection for VoiceFinder AP2620 Voice Interfaces]

E1 Interface Connection

Usually E1 VoIP module interworks with PBX through digital E1 line. APVI-1E1 VoIP Digital E1 Interface module supports ISDN-PRI, MFC-R2, DTMF signaling and accommodate maximum 30 voice channels.

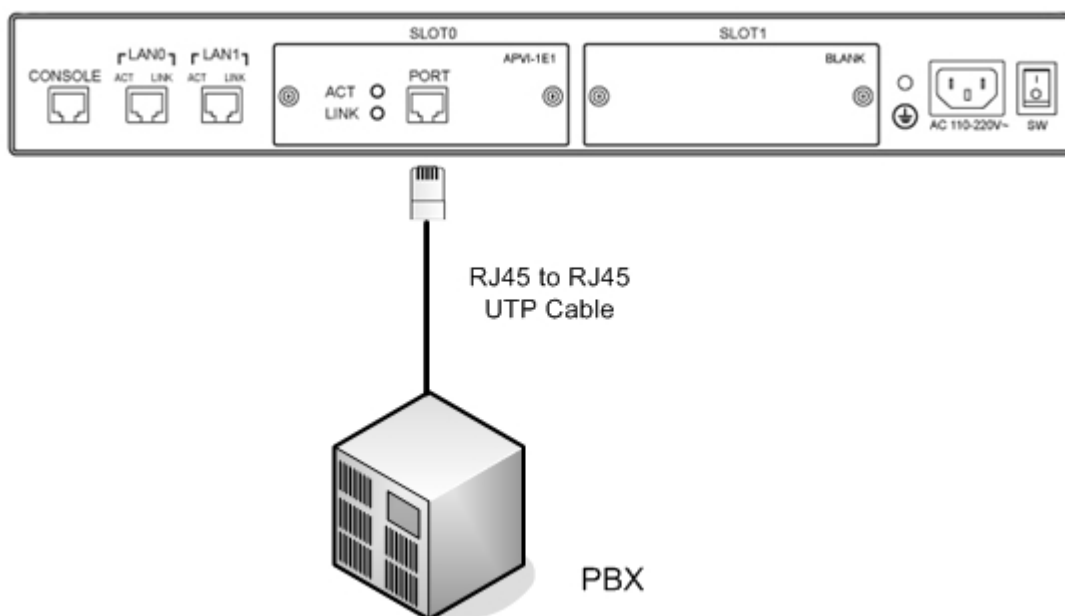

[Figure 3-4 Connection for VoiceFinder AP2620 E1 Interfaces]

Connection for AP2620 Interfaces

The below figure is an example of VoiceFinder AP2620 Gateway Interface connection.

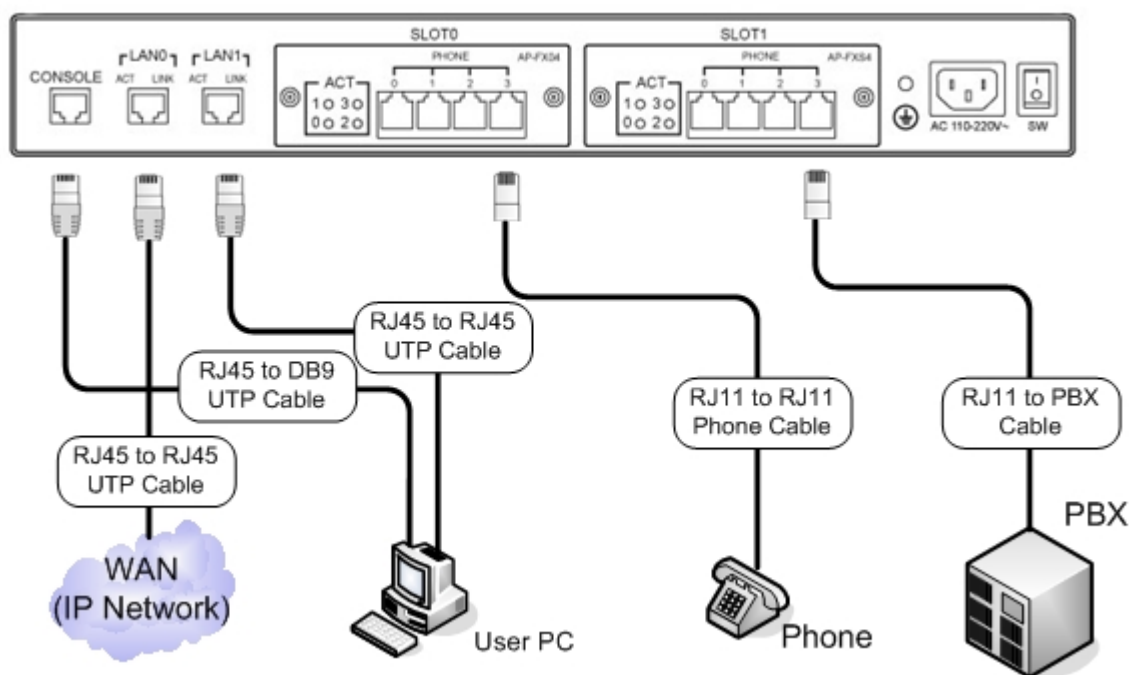

[Figure 3-5 An Example of the Interface Connection]

Chapter 4. Power Supply and Check Operational Status

AP2620 Gateway Booting and Operation

When power is supplied, the system is booted as described below.

- VoiceFinder AP2620 Gateway performs a self-test and checks basic operations of the CPU, the memory and interfaces.
- The boot loader is executed, and the boot loader seeks for proper software image files. The boot loader loads the broadcasting system software from the flash memory.
- If the boot loader cannot find proper software image file from the flash memory, the boot loader stands by in the boot mode until it receives proper software from the remote system. (At this time, the boot loader can download software through TFTP or FTP protocol.)
- When the software is loaded, the broadcasting system starts to operate according to configuration information. However, if there is no configuration information, it operates according to the default values, and in this case, the operator shall set up related items for normal operation of the network.

After connecting all the interfaces, supply the power to VoiceFinder AP2620 Gateway. Supply the power after connecting the adapter to VoiceFinder AP2620 Gateway. Do not connect the adapter to the power supply before connecting it to the gateway. Also, use 110V adapter in case the power supply is 110V. However, the gateway detects both 110V and 220V, so there is no additional setting required.

Use Console Terminal with HyperTerminal

- To use a PC as a Console terminal, the communication emulator application should be installed. When the PC is MS-Windows line, use the HyperTerminal Application.

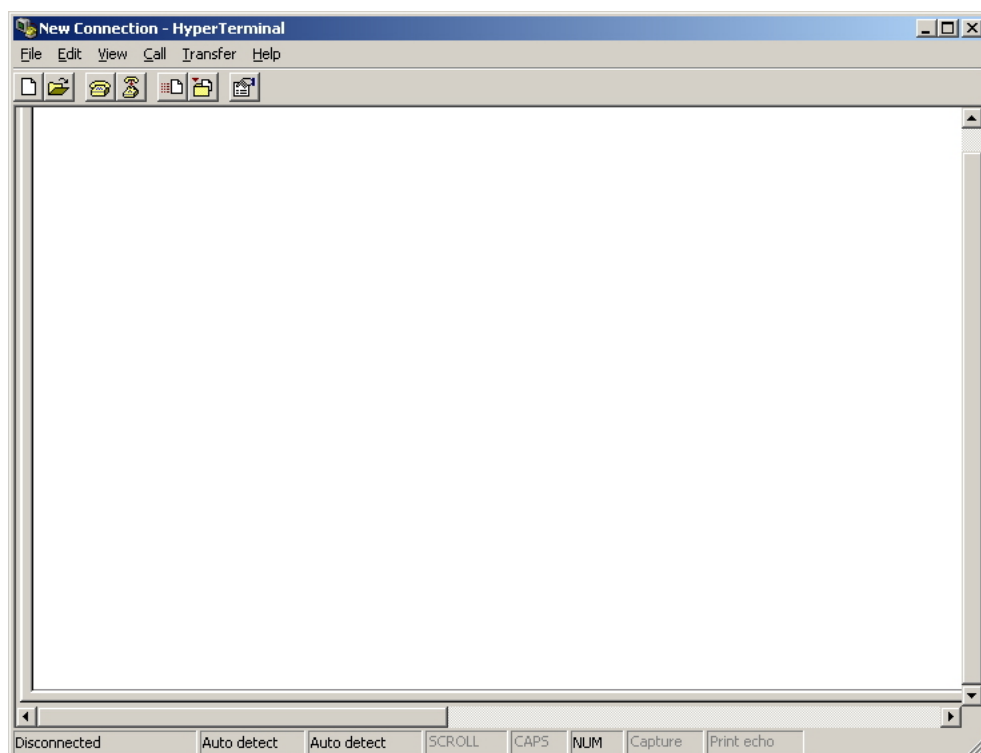

[Figure 4-1 MS-Windows Terminal Emulator - HyperTerminal]

- Assign a name to the connection. "AddPac" is used at the below example.

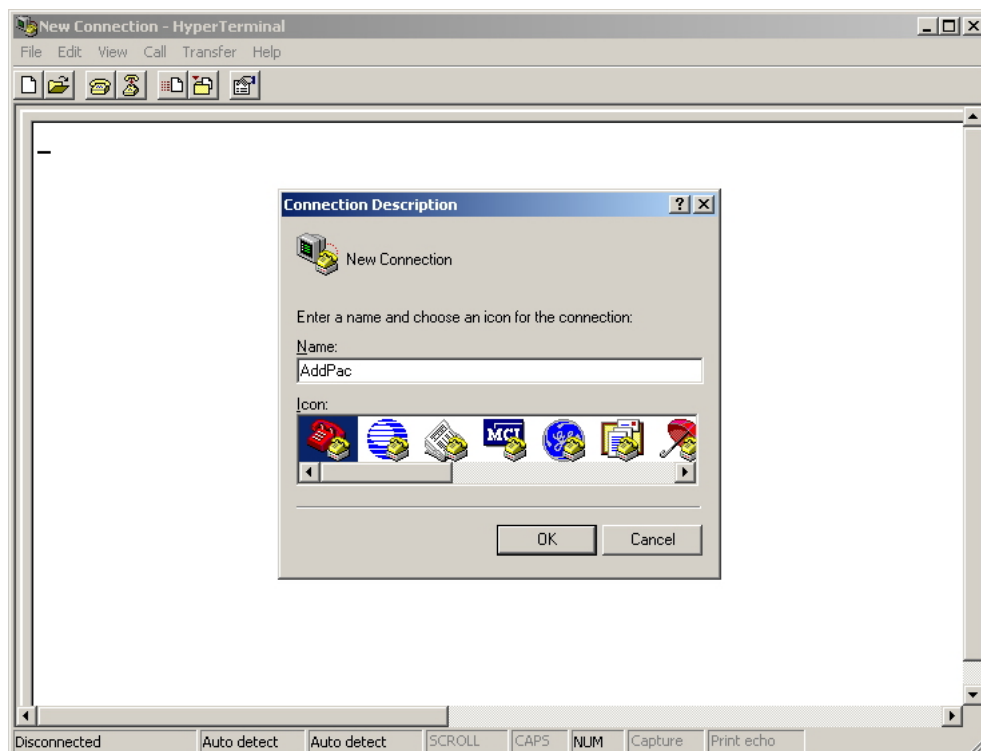

[Figure 4-2 Assign a name for the new connection in HyperTerminal]

Select the interface whether the Console cable is connected. Typically, the Console cable is connected to the RS-232C 9Pin Serial Port, so select the right port according to the user environment. "COM1" is selected at the below example.

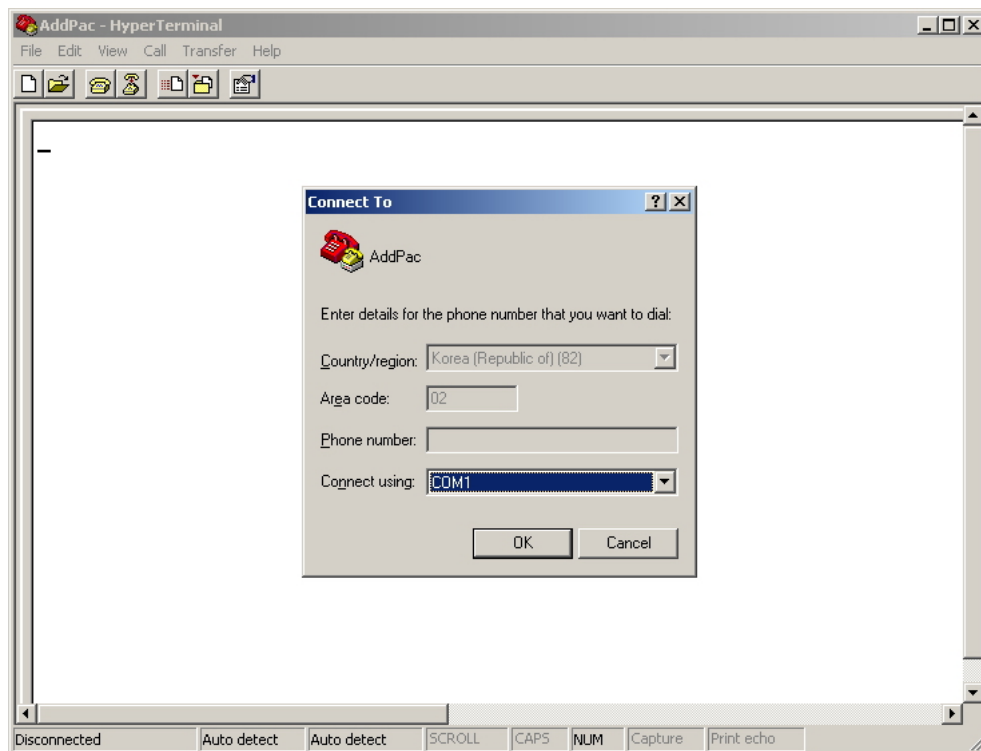

[Figure 4-3 Select the interface for Console cable]

- Set the port information. The below examples is based on “COM1” port.

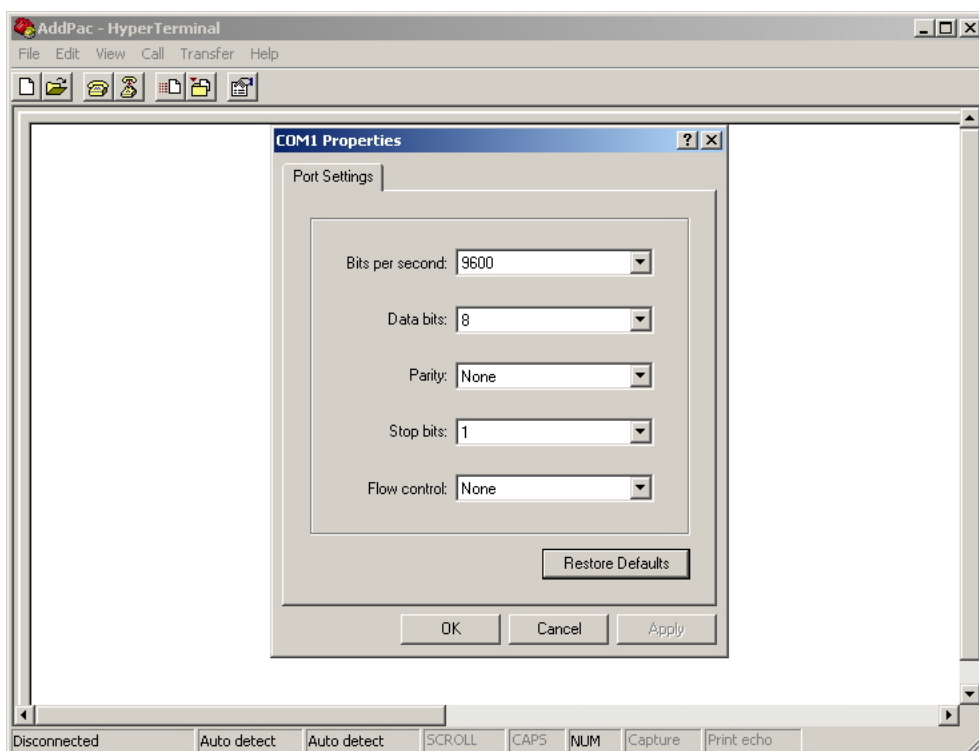

[Figure 4-4 COM1 Port Configuration]

- After the configuration, press "Enter" button, then the below message will be displayed on the HyperTerminal. This message shows the routing S/W version, Gateway H/W test result, memory and etc.

```
System Boot Loader, Version 2.2.4/WD [264MHz]
Copyright (c) by AddPac Technology Co., Ltd. Since 1999.

System Bootstrap, Version 1.2
Decompressing the image:
#####
#####
#####
#####[OK]

VoiceFinder Gateway Series (AP2620)
Serial Number: AP2620-XXXXXX
32BIT RISC Processor With 264MHz Clock
32 Mbytes System Memory
512 Kbytes System Boot Flash Memory
4 Mbytes System Flash Memory
Real-Time Clock Device with EEPROM

1 RS232 Serial Console Interface
2 Ethernet/IEEE 802.3 Interface (100BaseTX)

AP2620 System software Revision 8.21
Released at Thu May 12 18:00:00 2005
Program is 2574712 bytes, checksum is 0x14803011

Local Time : Fri May 20 12:31:20 2005
Copyright (c) by AddPac Technology Co., Ltd. Since 1999.

Hardware Revision ID = 0
Slot (0) Module type : FSS
Slot (1) Module type : OS3
```

```
The system is not configured yet or backup data is invalid.
Please login to system as a "root" and make configuration.

Flash ROM size is too small for IVR system
Voice Module Ready
DSP S/W download (0): .... OK
DSP S/W download (1): .... OK

The System is ready. Please login to system.

VoipGateway::Init1 - No IP address on the VoIP Interface
PS(0) install .... OK
PS(1) install .... OK

login:
login: root
password:
AP2620 - Login : root at Console on Fri May 20 12:31:40 2005
AP2620#
```

[Figure 4-5 The initial message of VoiceFinder AP2620 Gateway]

- With the log-in message, input the user name “root” and the password “router”. After the log-in process, the prompt “AP2620#” is displayed on the console terminal.

Chapter 5. Appendix

Cable Specification

This Appendix provides information about the Pinout specifications of the following cables used with VoiceFinder AP2620 Gateway.

- Console Port Signal and Pinout (RJ-45 to DB9)
- Ethernet Cable Assemble (RJ-45 to RJ-45) Pinout

[Console Port Signal & Pinout]

In order to connect the gateway console port with the Terminal Emulating PC, the RJ-45 to DB9 (Female DTE Connector) cable is used. The transferred signal and Pinout specifications are enlisted in the following table.

<Table 5-1> The transferred signal and Pinout specification

Gateway Console (DTE)	RJ-45	DB-9	Console Device (PC)
Signal	RJ-45 Pin	DB-9 Pin	Signal
RTS	1	8	CTS
DTR	2	6	DSR
TxD	3	2	RxD
GND	4	5	GND
GND	5	5	GND
RxD	6	3	TxD
DSR	7	4	DTR
CTS	8	7	RTS

[UTP cable (RJ-45 to RJ-45) Pinout]

In order to connect the gateway with other equipments (i.e. HUB), the RJ-45 to RJ-45 Ethernet Cable is used. The RJ-45 Connector Pin sequence is provided below and the transferred signal and Pinout specifications are enlisted at the below table.

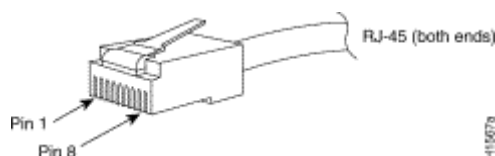

[Figure 5-1 100Base-TX RJ-45 Connector]

<Table 5-2> Signal and Pinout of Direct Ethernet Cable

RJ-45	Signal	Direction	RJ-45 Pin
1	Tx +	→	1
2	Tx -	→	2
3	Rx +	←	3
4	-	-	4
5	-	-	5
6	Rx -	←	6
7	-	-	7
8	-	-	8

1. These specifications are for serial cables connecting the gateway and the HUB.
2. For gateway to gateway or gateway to PC connection, the Cross Cable must be used.

[E1/T1 Cable (RJ-45 to PBX) Pinout]

- Addpac E1/T1 can be connected with RJ45 cable. RJ45 pin array is as below, PBX's RX is assigned for RJ45 pin 1 and 2, TX is for pin 4 and 5.

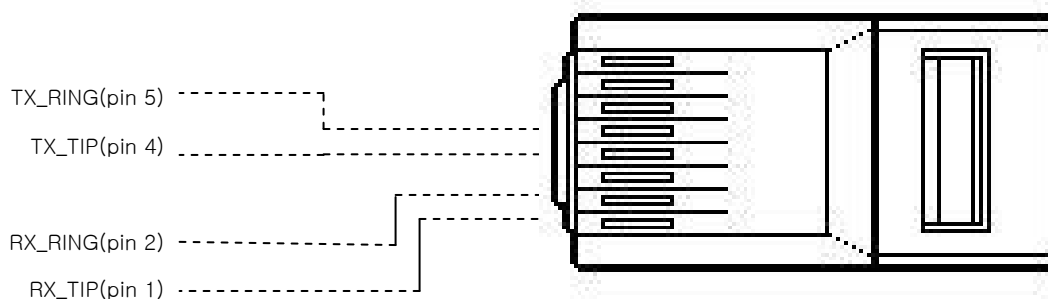

[Figure 5-2 Digital E1/T1 RJ45 Pinout]