

# AP-LMS1001

## 1-Port Analog/VoIP Land to Mobile Station Gateway

High Performance LMS(Land to Mobile Station) Gateway Solution



## Preliminary Product Overview

(Without notice, following described technical spec. can be changed)

# **AddPac**

## **AddPac Technology**

Sales and Marketing

[www.addpac.com](http://www.addpac.com)

# Contents

- Product Overview
- Hardware Specification
- Bluetooth Specification
- APOS Technology
- VoIP (Voice over IP) service
- Advanced QoS Features
- Network Protocols
- Network Management
- Smart Web Management
- Security Management
- Application Service
- Ordering Information

# Product Overview

## AP-LMS1001 1-Port FXS LMS Gateway

- Analog Interface (FXS)/VoIP Interface(LAN) Both Support
- Mobile Phone Interworking Solution via Bluetooth Technology
- H.323/SIP Dual Concurrent Stack Embedded
- High Performance RISC & Programmable DSP Architecture
- Two(2) 10/100Mbps Fast Ethernet (IP Share, etc)
- High Performance LAN-to-LAN Routing Capability
- G.711/G.726/G.723/G.729, T.38 Fax , VAD, etc
- Powerful Network Protocols (PPPoE, DHCP, Static Routing, etc)
- Firmware Upgradeable Architecture
- VPMS (VoIP Plug & Play Management System) for Large Scale Deployment
- Advanced Voice QoS Mechanism
- Light and Compact Design with External Power Supply

# Product Highlights

AP-LMS1001 1-Port FXS LMS Gateway

## Powerful LMS Gateway

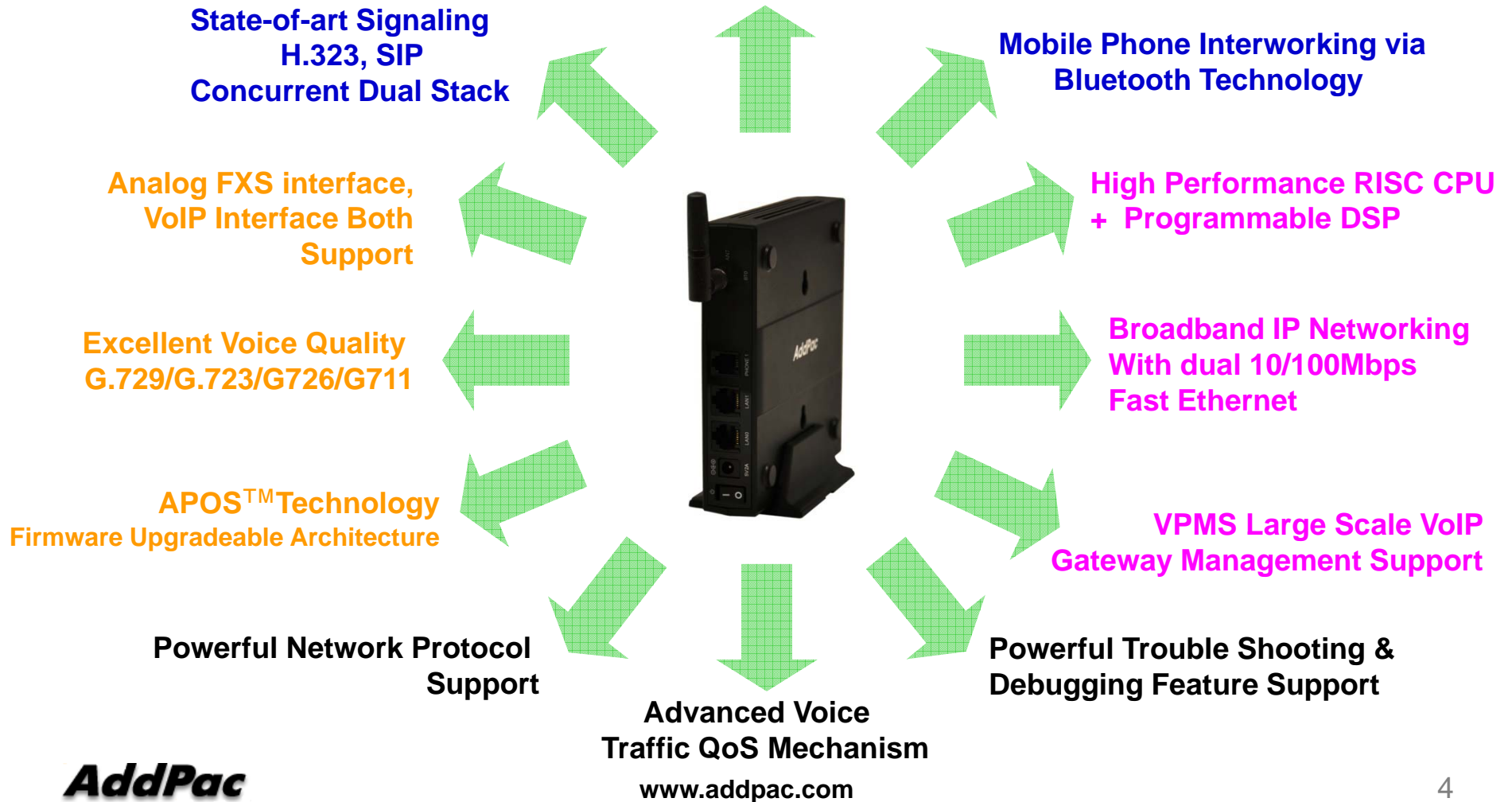

# APOS Technology

AP-LMS1001 1-Port FXS LMS Gateway

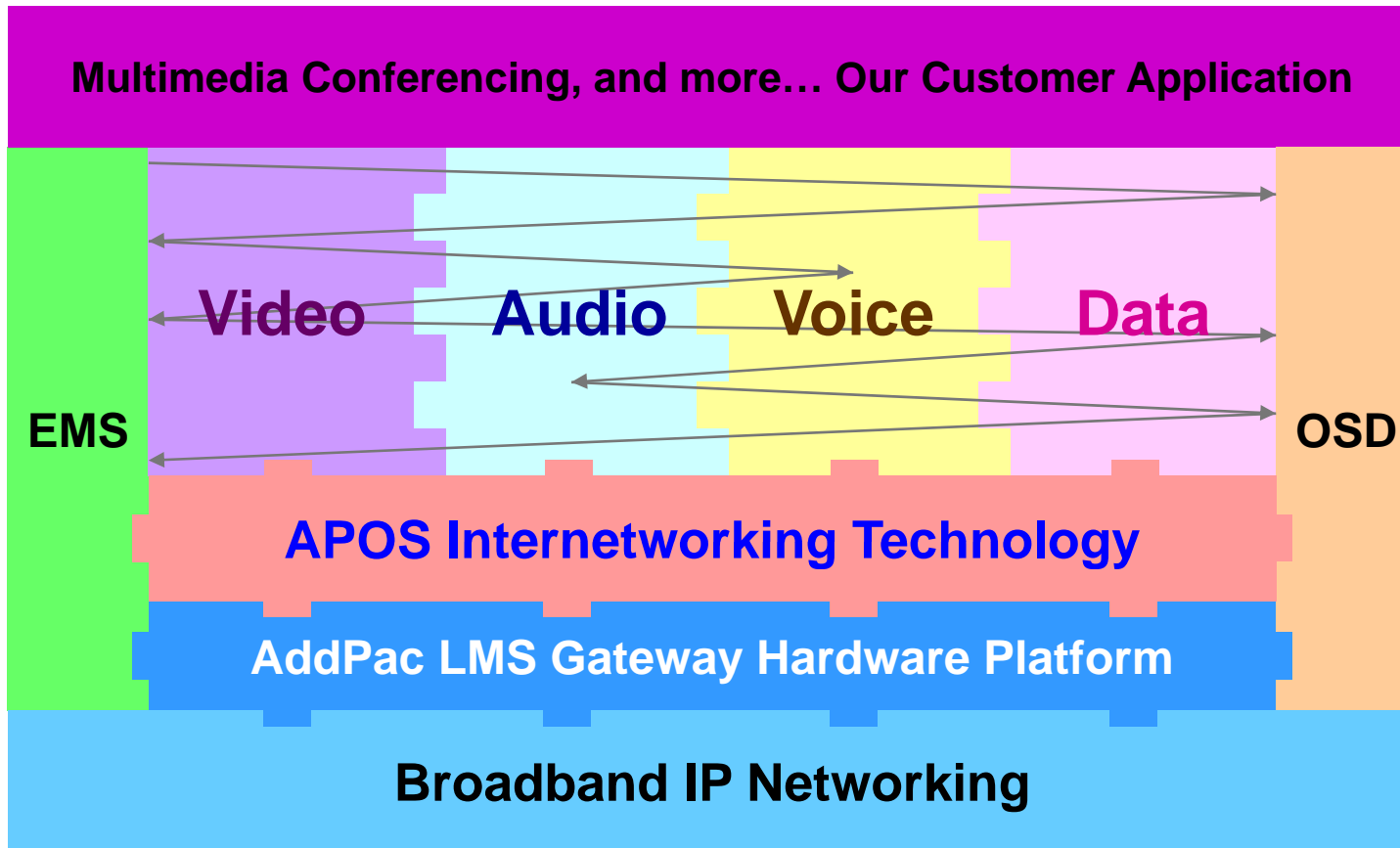

- APOS : AddPac Internetworking Operating System
- OSD : On- Screen Display
- EMS : Element Management System

# Hardware Specification

AP-LMS1001 1-Port FXS LMS Gateway

RISC  
CPU

High-end  
DSP

- **RISC Microprocessor Computing Power**
- **1-Port LMS Gateway**
- **1-Port Antenna Interface**
- **VoIP Gateway Interface**
  - AP-LMS1001 Model A: Basic Configuration
  - AP-LMS1001 Model B: One(1) FXS Port
- **Network Interface for VoIP Direct Interface**
  - Two(2) 10/100Mbps Fast Ethernet (RJ45)
- **Run LED, LAN LED, Port LEDs**
- **External Power Supply**

# Hardware Specification

AP-LMS1001 1-Port FXS LMS Gateway

RISC  
CPU

High-end  
DSP

## LSM Gateway Service Diagram

AP-LMS1001 LMS Gateway Internal H/W Block Diagram

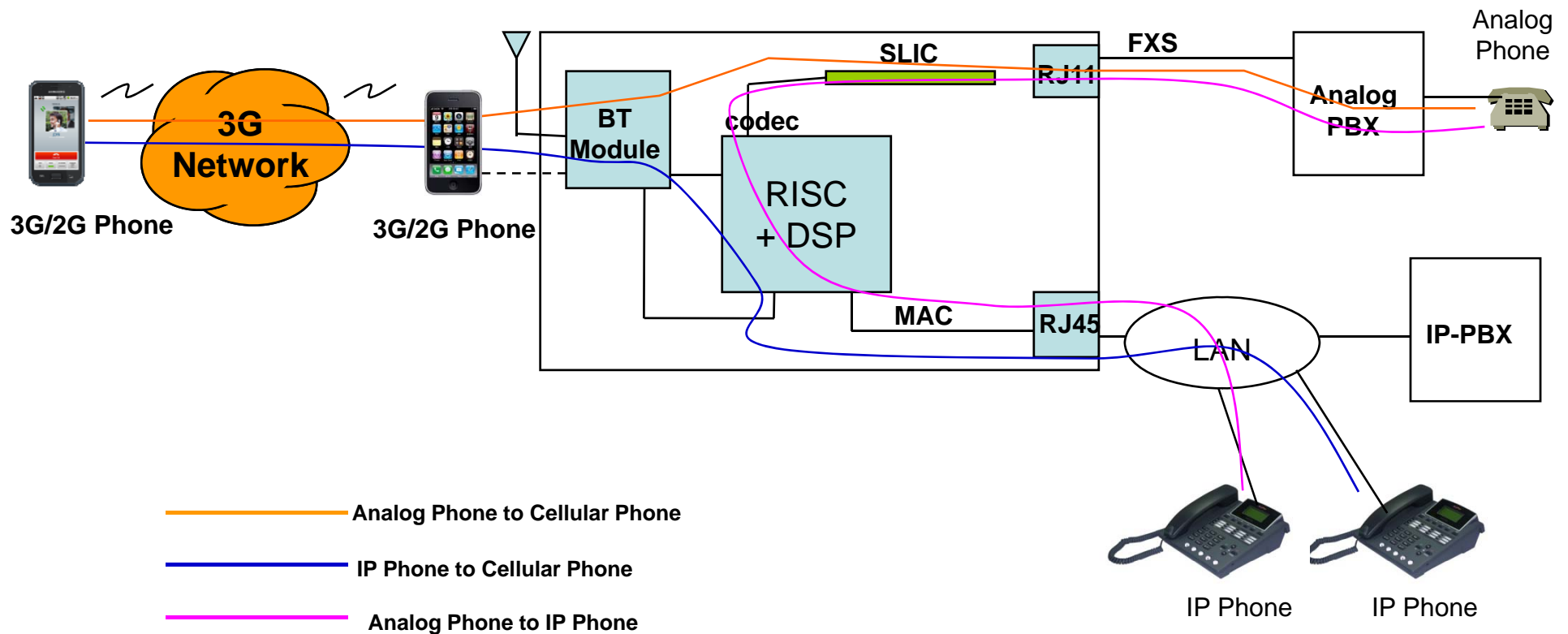

# Hardware Specification

## AP-LMS1001 1-Port FXS LMS Gateway

### Hardware Specifications

| AP-LMS1001<br>LMS Gateway | Basic Specifications                                    |
|---------------------------|---|
| Voice Interface           | No FXS Port : Model A                                   |
|                           | One(1)-Port FXS Analog Interface : Model B              |
| Antenna Interface         | External Antenna  |
| Ethernet Interface        | 2-Ports 10/100Mbps Ethernet Interface(RJ-45)            |
| Flash Memory              | 4Mbyte High-speed Flash Memory                          |
| Base Memory               | 32 Mbyte High-speed SDRAM                               |
| Power Requirement         | Power Supply Adaptor / VAC 110~220V,<br>50/60Hz, 5V, 2A |
| Operating Temperature     | 0°C ~ 45°C (32 °F ~ 122°F)                              |
| Storage Temperature       | -40°C ~ 85°C (-40°C ~ 185°F)                            |
| Relative Humidity         | 5% ~ 95% (Non-condensing)                               |
| Dimension                 | 142mm x 142mm x 28mm (W x D x H)                        |
| Weight (Kg)               | 0.41Kg  |

### Network interface Configurations

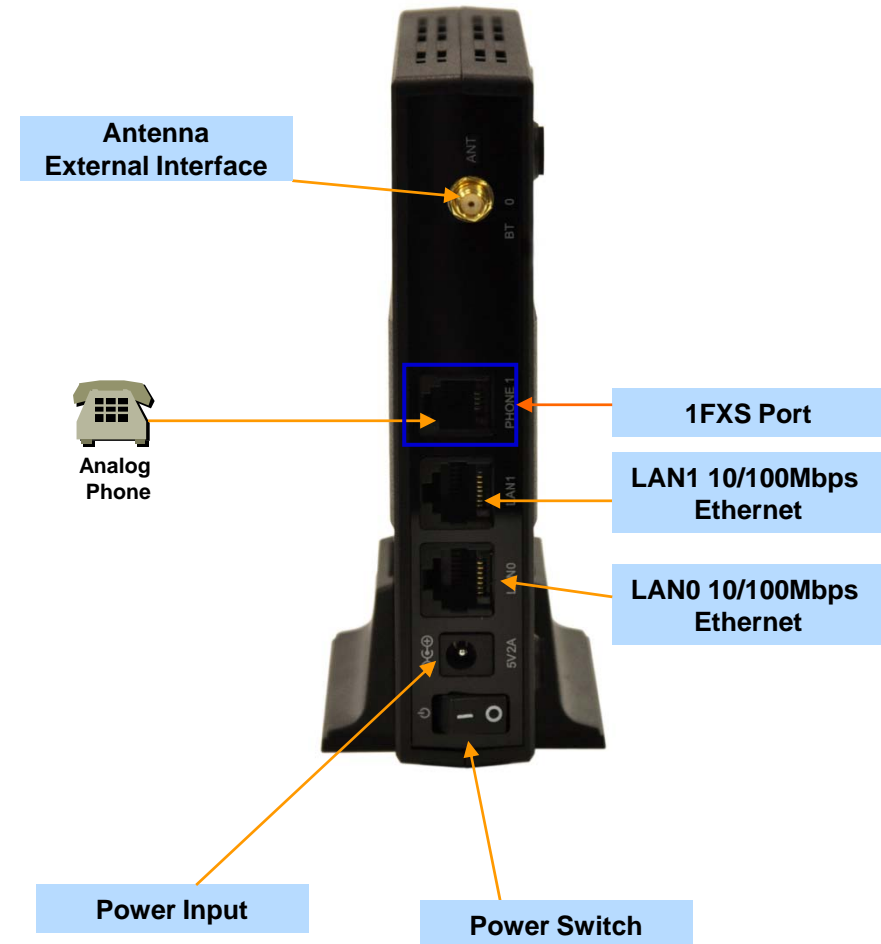



# VoIP (Voice over IP) Service

AP-LMS1001 1-Port FXS LMS Gateway

- **H.323, SIP Dual Stack**
- **H.323**
  - ITU-T Standard H.323 v3 Support
  - Support H.245 Tunneling
  - Including H.235 Security Features
- **SIP**
  - IETF RFC3261 or RFC2543 SIP Standard

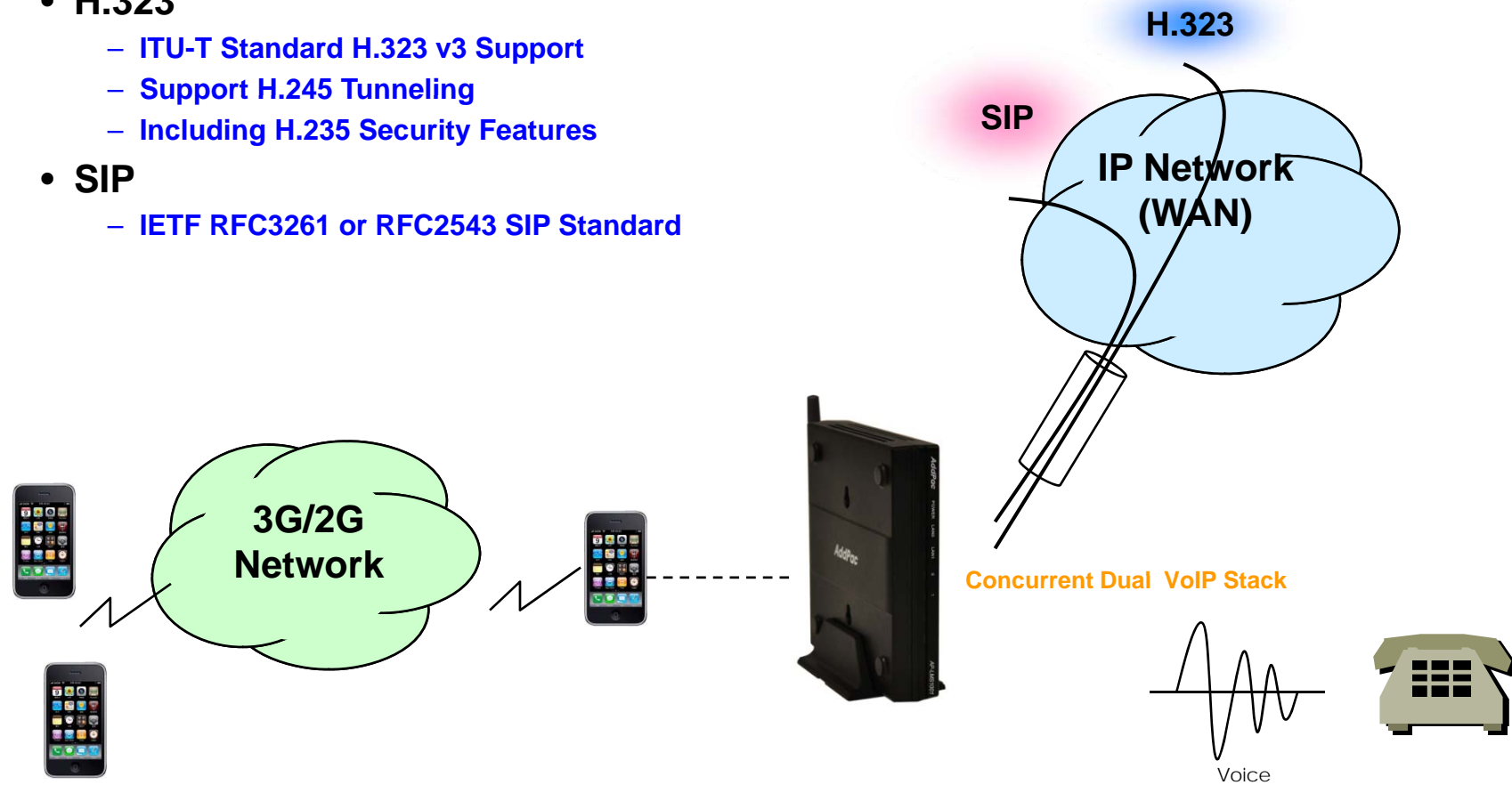

# VoIP (Voice over IP) Service

## AP-LMS1001 1-Port FXS LMS Gateway

- **H.323**

- Fast connect, normal connect support
- H.245 tunneling support
- Q.931 response message setting for inbound VoIP calls
- H.245 logical channel open timing selection function
- Start H.245 procedure support
- DTMF / Hook flash relay with H.245 alphanumeric / signal
- Secondary gatekeeper support
- Gatekeeper assignment according to the domain name
- Gatekeeper discovery with multicast
- Lightweight RRQ support
- Signaling TCP port assignment
- Resource threshold setting with RAI
- H.235 clear-token, crypto-token support
- canMapAlias support
- Technical prefix (supported prefix) support
- Public IP assignment in NAT environment

- **SIP**

- Gateway-based / Endpoint-based registration support
- Secondary proxy-server assignment function
- SIP signaling port change function
- SIP proxy server assignment according to the domain name
- T.38 real-time fax relay support
- DTMF relay support with RFC2833 / OPTION message
- Re-INVITE support

# VoIP (Voice over IP) Service

## AP-LMS1001 1-Port FXS LMS Gateway

- **Voice Codec**

- G.711 A-Law, G.711 U-Law
- G.726 r16, G.726 r32
- G.729A
- G.723.1 r63, G.723.1 r53
- VAD (Voice Activity Detection) function support
- DTMF relay support (H.323, SIP, MGCP common) based on RFC2833

- **RTP**

- Redundant RTP packet transmission in case of severe packet loss
- Dynamic jitter buffer management and RTP packet jitter and loss compensation with heuristic & DSP error concealment
- Static jitter buffer setting support
- Voice frame per RTP packet number control for each codec
- In-band ring-back tone support
- Virtual ring-back tone support
- Tone parameter change support

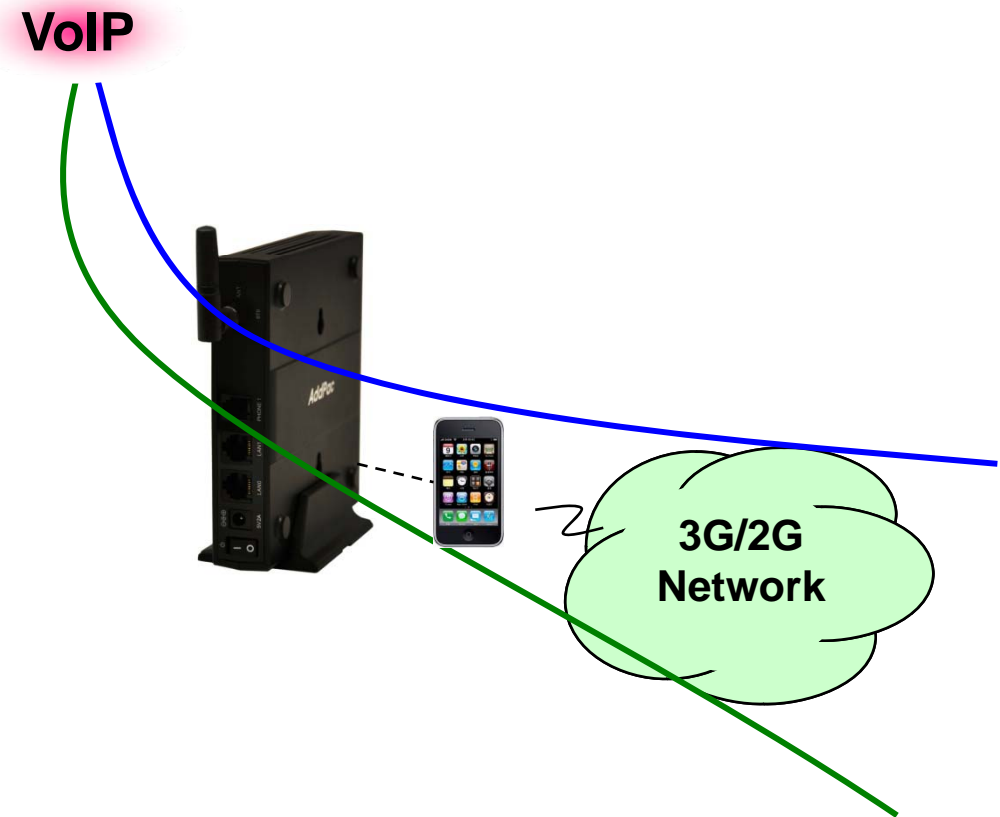

# VoIP (Voice over IP) Service

## AP-LMS1001 1-Port FXS LMS Gateway

### • VoIP Call Controls

- Hot line connection function with PLAR (Private Line Auto Ring Down)
- Leased line emulation function
- Connection monitoring function
- Fault tolerant with Redundancy and Call Distribution among Gateways for load balancing
- Call attempt with IP address
- H.323, SIP, MGCP inbound call connection for each voice port
- Multiple E.164 setting for one voice port
- One E.164 or digit pattern can be assigned to more than one voice port
- Hunting with Longest match/ priority/ sequence/ random
- One stage call setup by Digit forwarding
- Call barring with specific digit patterns
- Calling and called number conversion for PSTN outbound calls
- PSTN rerouting in case of VoIP call attempt failure

### • VoIP Call Controls (cont.)

- Call transfer for internal calls
- Call pickup for internal calls
- Calling and called number conversion for VoIP outbound calls
- Calling and called number conversion for VoIP inbound calls
- Fax broadcasting call control

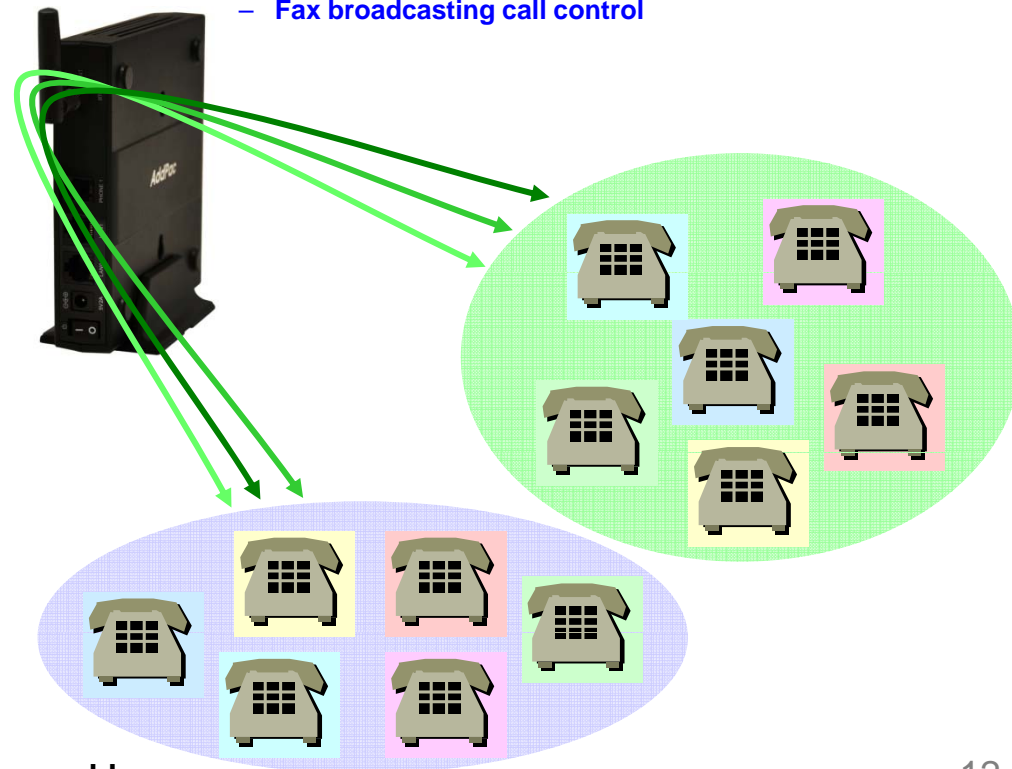

# Advanced QoS Features

AP-LMS1001 1-Port FXS LMS Gateway

- Enhances **Transmit** Voice QoS Features

- Voice Traffic Priority Queuing
- QoS Service Profiling
- Providing Virtual Network Transmit Algorithm
- Real-time Voice Traffic QoS Support
- RTP Packet Transmit Interval Control
- Supporting RTP Packet Redundancy Scheme
- IP Header Control such as ToS, Diffserv

- Enhances **Receive** Voice QoS Features

- Dynamic Jitter Buffer Management
- Error Concealment
- Support T.38 FAX Data Error Recovery Scheme

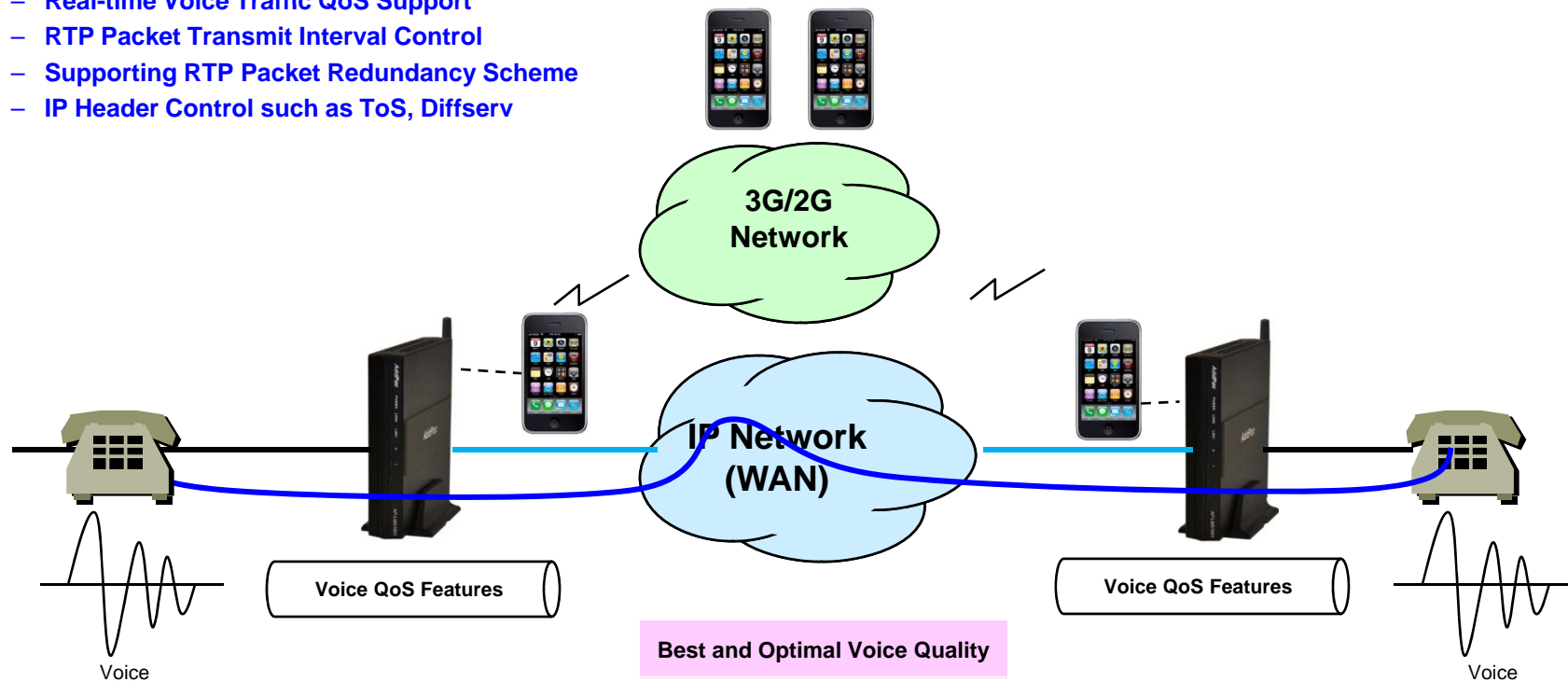

# Network Protocols

AP-LMS1001 1-Port FXS LMS Gateway

## Basic Network Protocols

- ARP, IPv4, TCP, UDP, ICMP, SCTP, IGMP, MLD

## Routing Protocol

- IPv4 : Static

## Service Protocol

- FTP, Telnet, TFTP, DHCP Server/Relay, SNMP Server
- CDP (Cisco Discovery Protocol)
- DNS Resolver , DDNS(nsupdate)
- Bridge
- Syslog

## IPv4 Address Configuration

- Fixed (Static)
- DHCP
- PPPoE

## Miscellaneous

- Cisco Style CLI
- Standard & Extended IPv4 Access List
- Multi-level User Account Management
- IP accounting
- STUN Client

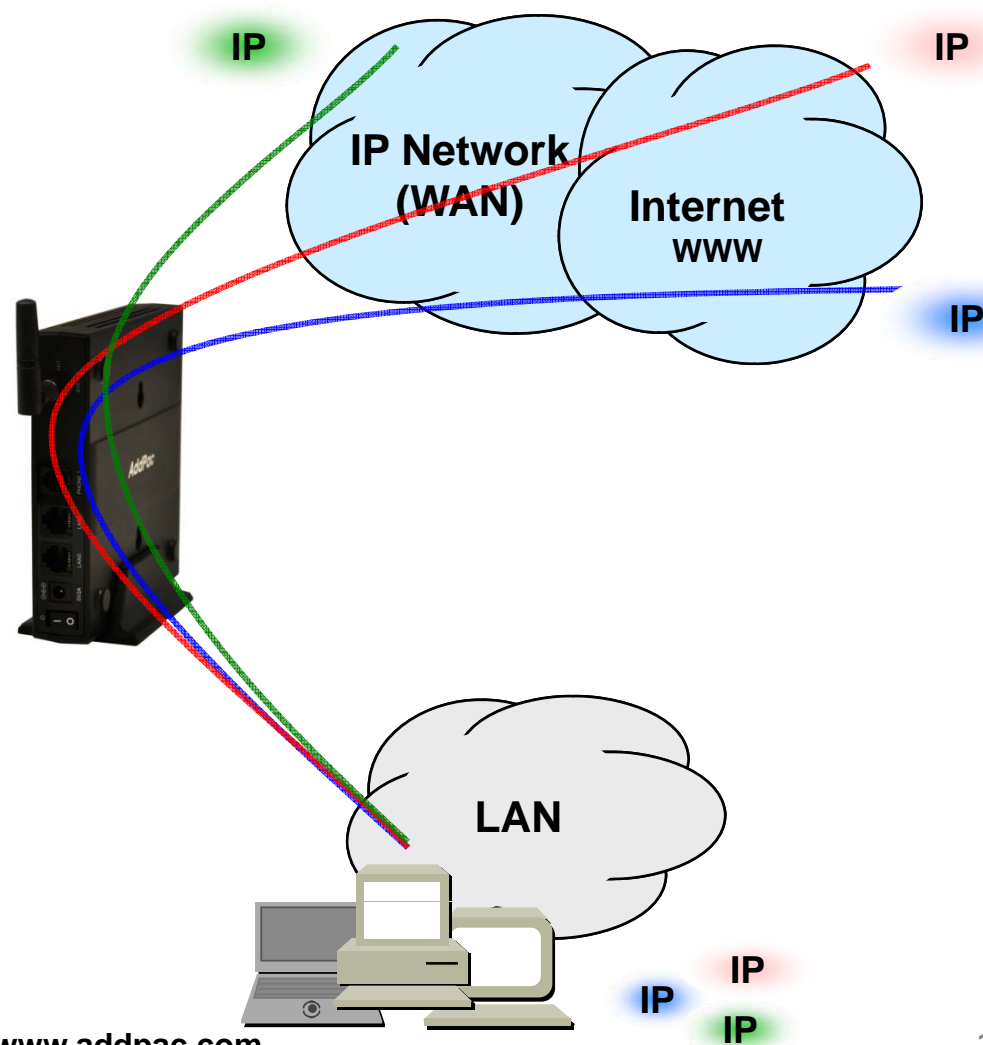

# Network Management

## AP-LMS1001 1-Port FXS LMS Gateway

- **SNMP**
  - Standard Simple Network Management Protocol( SNMP) Agent support
  - MIB v1 and v2 Support
- **Web-based Management**
  - Smart Easy Setup
  - Standard Voice Interface
  - Standard PSTN Back-up Interface
- **Watch-dog Function**
  - Hardware, Software watch-dog services
- **Remote Management**
  - Telnet
  - Rlogin
- **Auto Upgrade Service**
  - HTTP server based APOS image and configuration file auto-upgrade support
- **Batch Job Function**
  - Text based script downloading

- **Interoperable with AP-VPMS Service**
  - AddPac VoIP Plug & Play Management System (AP-VPMS)

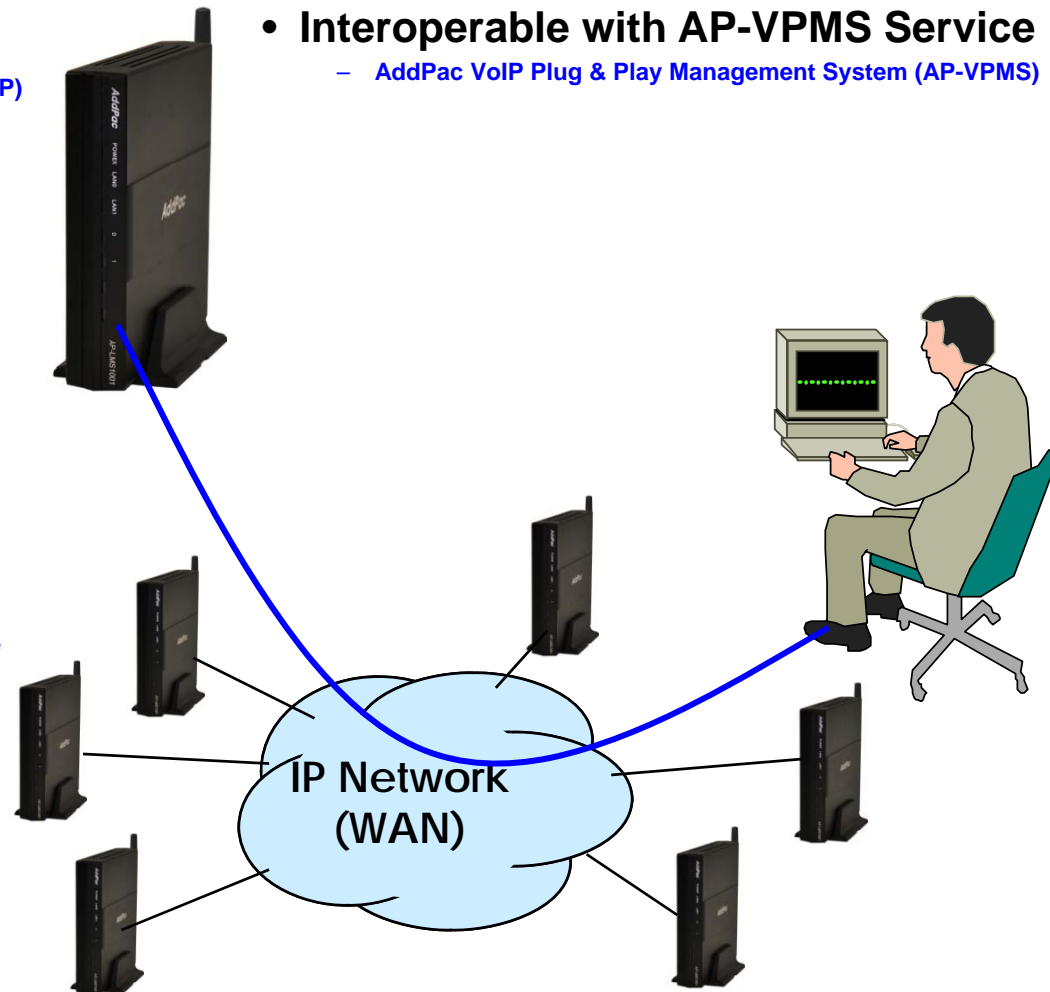

# Smart Web Manager : Main Page Layout

## AP-LMS1001 1-Port FXS LMS Gateway

**Main Menu**  
For easy system setup, provide the various menu and category

- System
  - Network Setup
  - Language
  - NTP
  - Backup/Restore
- Basic
  - Protocol
  - Server SIP
  - Server H.323
  - Tel Number
  - FXS/FXO/E1 Group
  - E1 Trunk
  - DTMF/CODEC
  - Dial Plan/Prefix
  - Static Route
  - Hot Line
- Advanced
  - Gain
  - Fax
  - Service
  - Filtering
  - Security
  - SNMP
- Miscellaneous
  - Call Status
  - System Status
  - Alarm Status
  - Call Log
  - System Log
  - Test Call
  - Ping

**Tool Bar**  
Provide frequently used tools like as System Update, Configuration Backup, Initialization, Restart, Telnet

**System Information**

|                        |  |
|------------------------|--|
| HW Version             | 2.0  |
| S/W Version            | ap1800k_web_g2_v8_47T.bin 8.47                   |
| MAC Address            | 0002.a511.2245                                   |
| VoIP Protocol          | SIP  |
| Voice Interface Module | S(4)O(4) : E1(2)                                 |
| Registration Status    | Unregistered                                     |
| Supported Codec List   | g711alaw g711ulaw g7231r53 g7231r63 g726r32 g729 |
| Network Information    | Static 172.16.50.114                             |
| WAN LINK Status        | 100Mbps FULL Duplex Link UP                      |
| LAN LINK Status        | Link Down  |
| Current Time           | Thu Oct 1 13:06:23 2009                          |
| System Startup Time    | Thu Oct 1 12:56:46 2009                          |
| System Running Time    | 0 days 00:09:37                                  |
| Total Calls            | 0  |

**Information**  
Display the current system version and status summary

Information

AddPac Tehonology  
Model : AP1800K\_G2  
H/W Version : 2.0  
S/W Version : 8.47  
Smart Web Version : 0.3  
Smart Web Build : Oct 1 2009  
Voice Interface  
S(4)O(4) : E1(2)  
Protocol : SIP  
Status : Unregistered  
CurrentCalls : 0 Call  
Network : Static 172.16.50.114  
Mac Address: 0002.a511.2245

**Description**  
WAN 포트에 대한 설정입니다. Static IP의 경우 고정 IP 주소로 사업자로부터 할당 받은 주소 정보를 입력합니다. DHCP와 PPPoE의 경우 유동 IP로 장비의 주소가 변경될 수 있습니다. DHCP 및 PPPoE는 사용자 환경에 맞도록 설정하십시오. MAC 주소 변경은 필요시 장비에 설정된 주소를 사용하지 않고사용자가 설정한 주소를 사용하는 방안으로 반드시 필요한 경우에 한하여 사용하여야 합니다.

**Workspace**  
Workspace for detailed action

**Description**  
Display the help message if you move mouse over main menu

©AddPac Tehonology 2008-2009. all rights reserved.



# Smart Web Manager : SIP Server (Example)

AP-LMS1001 1-Port FXS LMS Gateway

**Smart Web Manager**  
www.addpac.com

**SIP (Session Initiation Protocol)**

Use SIP Server  Yes  No

Primary SIP Server   Server address (IP or Domain Name) and Port (default 5060)

Secondary SIP Server   Server address (IP or Domain Name) and Port (default 5060)

Local Domain name  (SIP userpart of authentication)

SIP Signaling Port  (default 5060, between 1 to 65535)

Register Expiration  (in seconds, default 60, between 10 to 86400)

Session Re-Fresh  INVITE  UPDATE

Session Expire Time  (in seconds, default 1800, between 30 to 86400, 0 = disable)

Apply

**SIP Server**  
Primary & Secondary server,  
Local domain name,  
SIP Signaling Port ( **reboot necessary** )  
Timer  
\* register expire  
\* session refresh  
\* session expire

**Information**  
AddPac Technology  
Model : GS1002\_G2  
H/W Version : 2.0  
S/W Version : 8.00d  
Smart Web Version : 0.4  
Smart Web Build : Mar 24 2010  
Voice Interface  
G(2)S(2)  
Protocol : SIP  
Status : Unregistered  
CurrentCalls : 0 Call  
Network : Static 172.16.9.16  
Mac Address : 0002.a400.0000  
Unread Message:  
P0:0(0)  
P0:1(0)

**Description**  
Configure the settings for SIP.  
Contact your service provider  
for the settings

# Smart Web Manager : FXS Extension (Example)

## AP-LMS1001 1-Port FXS LMS Gateway

**Port Information**  
voice port type & physical port

| Port  | P0  | P1  | P2  | P3  |
|-------|-----|-----|-----|-----|
| SLOT0 | GSM | GSM | FXS | FXS |

**FXS Extension Configuration**

| Index | Port | Numbers | Preference | HuntStop | Select                   |
|-------|------|---------|------------|----------|--------------------------|
| 0     | 0/2  | 1234    | 0          | 0        | <input type="checkbox"/> |

**FXS Extension**  
Configure phone-number for using inter-office Preference ( 0 : highest )

**Information**  
AddPac Technology  
Model : GS1002\_G2  
H/W Version : 2.0  
S/W Version : 8.00d  
Smart Web Version : 0.4  
Smart Web Build : Mar 24 2010  
Voice Interface  
G(2)S(2)  
Protocol : SIP  
Status : Unregistered  
CurrentCalls: 0 Call  
Network : Static 172.16.9.16  
Mac Address: 0002.a400.0000  
Unread Message:  
P0:0(0)  
P0:1(0)

**Description**  
Set up for using FXS port to extension number (forwarding No)

# Smart Web Manager : Call Status (Example)

AP-LMS1001 1-Port FXS LMS Gateway

The screenshot shows the 'Call Status' page in the Smart Web Manager interface. The page is divided into several sections:

- System:** A sidebar menu with options like Network Setup, Language, NAT, DTMF, etc.
- Call Status:** The main content area, which includes:
  - Port Status (Analog):** A table showing the status of ports in Slot 0. The table has columns for Port (0(), 1(), 2(), 3()) and rows for Status and Select. All ports are currently in an 'I' (Idle) state.
  - Unblock/Block:** Two buttons to manage port status.
  - Legend:** A color-coded legend for Connection State (Connected, Disconnected, Blocked) and Call State (Idle, Ring, Called, Calling, Blocked).
  - Call Status Table:** A table with columns for Port, Direction, Established Time, Calling Number, Called Number, CODEC, and Src/Dest. IP.
- Information:** A sidebar on the right containing system details like Model (GS1002\_G2), H/W Version (2.0), S/W Version (8.00d), and current call information.
- Description:** A sidebar on the right with a note: 'Verify port status and retrieve the present call information'.

Two callout boxes provide additional context:

- Analog Port:** Real-time display about analog port status (occupation, call status). Provide a specific port blocking function.
- Active Call Status:** Real-time display about current active call status (calling party addr, called party addr, Codec, etc).

# Security Management

## AP-LMS1001 1-Port FXS LMS Gateway

- IP packet filtering
- IP access list
- User authentication function
  - Password Authentication Protocol (PAP)
  - Challenge Handshake Authentication Protocol (CHAP)
- Enable/Disable specific protocols
- Auto-square connect of Telnet session
- Account Management function for multi-level user
- SNMP/TELNET/FTP/HTTP/TFTP port assignment function
- SNMP/TELNET/FTP access list management
- Boot mode security checking function

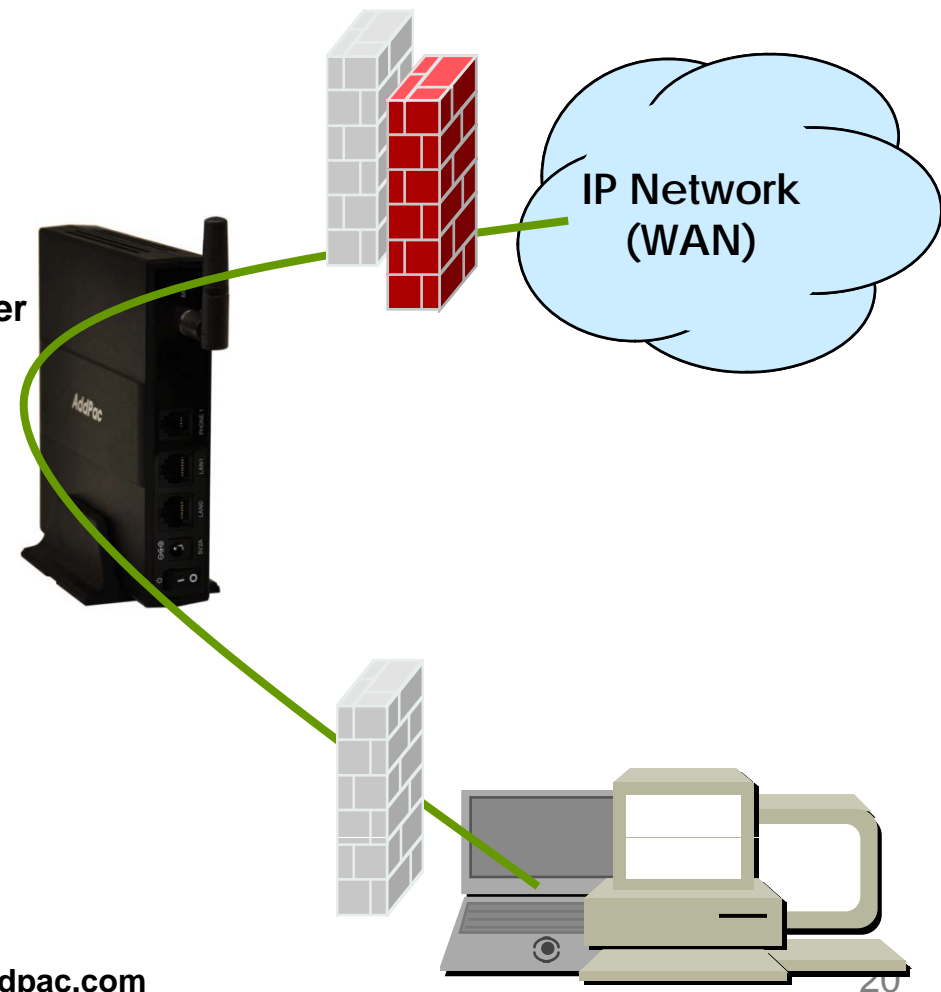

# Standard Application

AP-LMS1001 1-Port FXS LMS Gateway

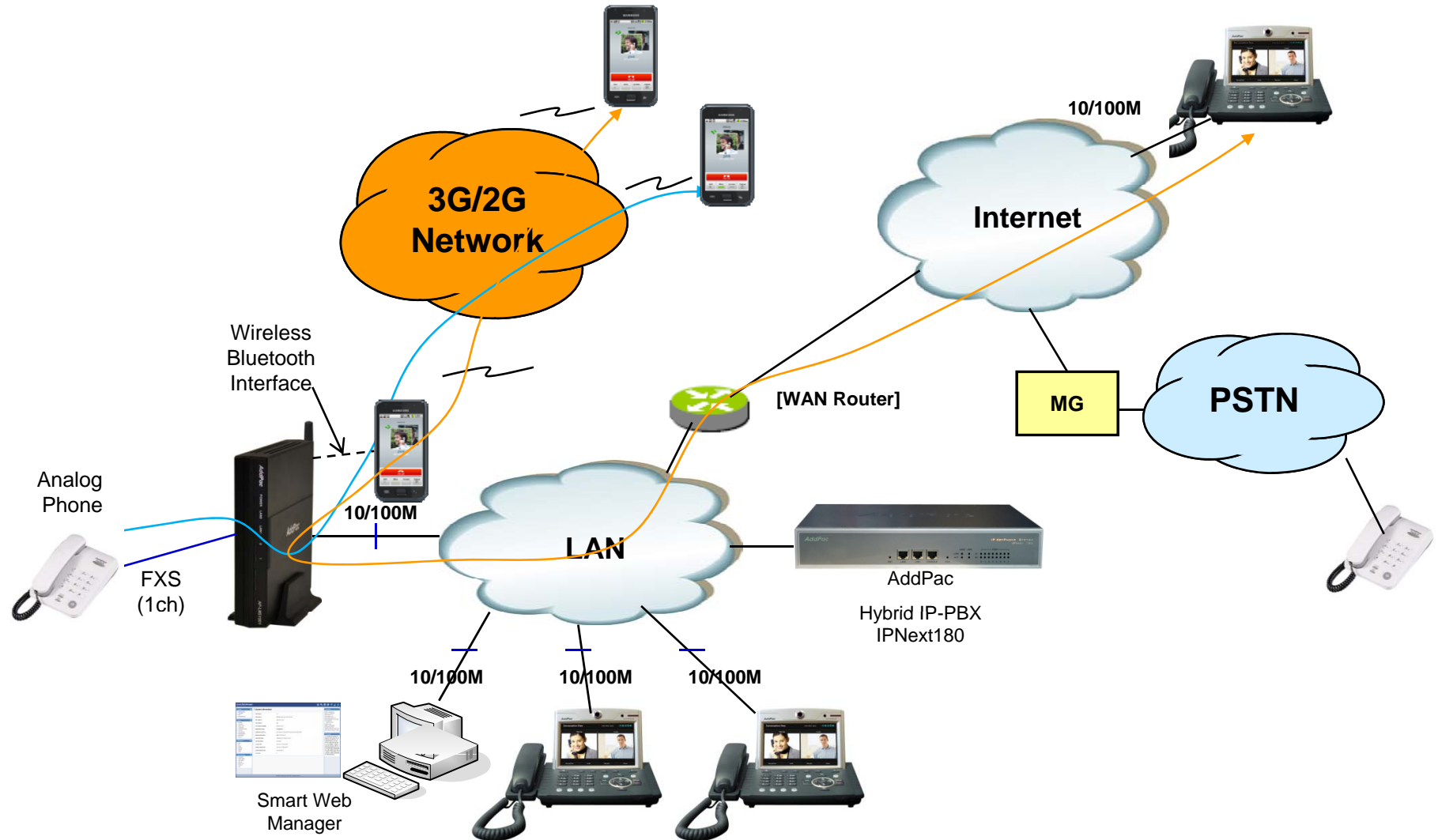

**AddPac**

[www.addpac.com](http://www.addpac.com)

# Ordering Information

- AP-LMS1001 1-Port LMS Gateway Hardware
  - AP-LMS1001 LMS Gateway Main Body
  - RISC Microprocessor with High-end Programmable DSP Architecture
  - One(1) Antenna Interface
  - 1-Port FXS Interface(1xRJ11)
  - 2-ports 10/100Mbps Fast Ethernet(RJ45)
  - Including Network Cable, Antenna & Ext. Power Supply, etc.
- Built-in APOS Internetworking Software for AP-LMS1001
- Including 1 Year Hardware Warranty
- Product Documents
  - Install and Operation Guide (PDF)
- Pricing
  - AddPac Technology Regional Sales Manager
  - Authorized Sales and Marketing Representatives
  - Please Contact [www.addpac.com](http://www.addpac.com)

# GSM Gateway Series

# Thank you!

**AddPac Technology Co., Ltd.**  
Sales and Marketing

Phone +82.2.568.3848 (KOREA)

FAX +82.2.568.3847 (KOREA)

E-mail [sales@addpac.com](mailto:sales@addpac.com)