



VoIP

Voice over IP Gateway



July 2003

Technical Sales and Marketing

Addpac Technology

www.addpac.com

AddPac VoIP Products Road-Map

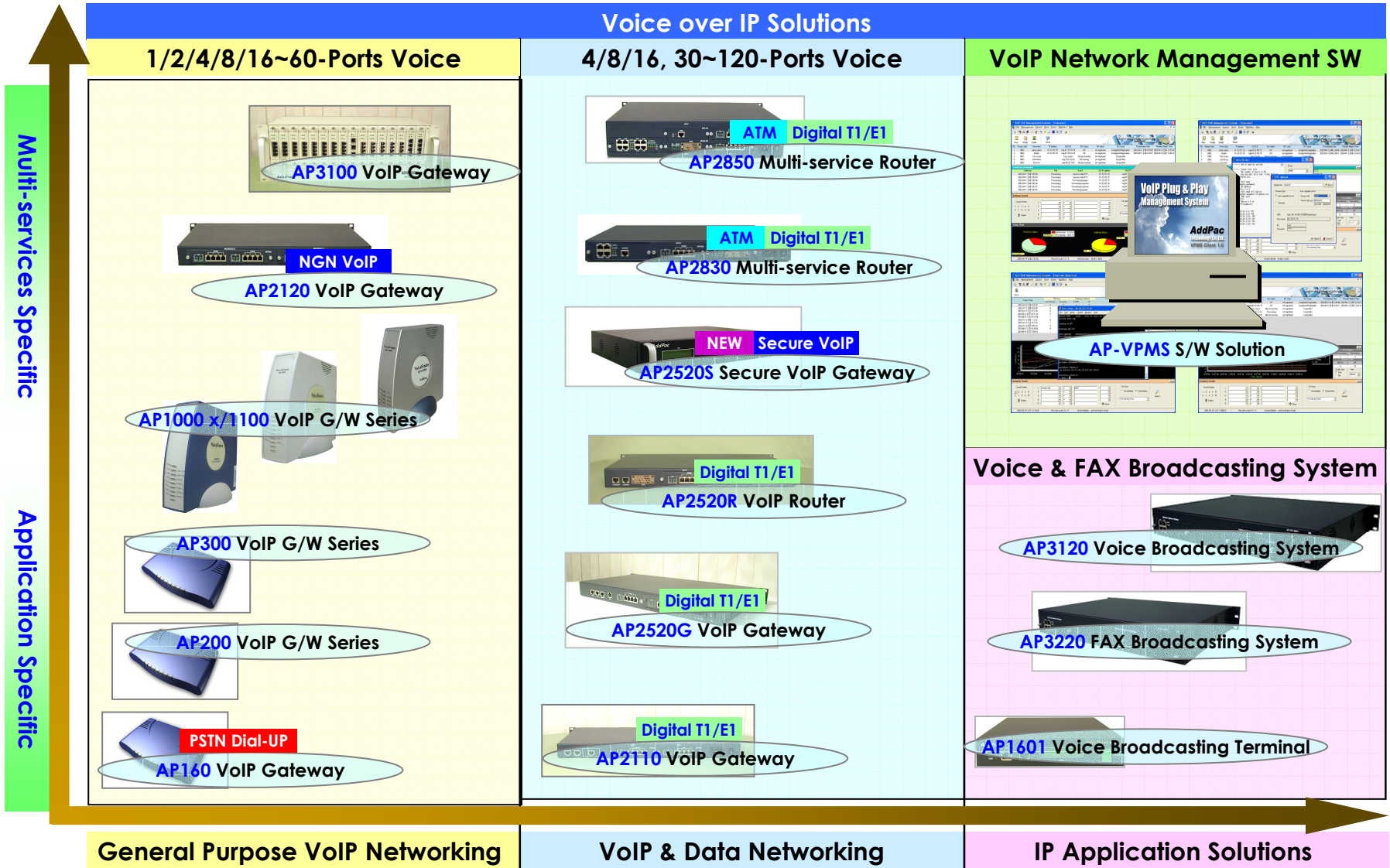

AddPac AP1000 Series Products Road-Map

4-Ports Voice Interface with Ethernet

AP1000 Gateway



4-Port FXS Voice
2-port 10Mbps Ethernet Interface
1-Port PSTN Back-up
1-Port Console, Voice QoS Features
APOS & AP-VPMS Support

AP1002 Gateway



2-Port FXS & 2-Port FXO Voice
2-port 10Mbps Ethernet Interface
1-Port Console, Voice QoS Features
APOS & AP-VPMS Support

AP1005 Gateway



4-Port FXO Voice
2-port 10Mbps Ethernet Interface
1-Port Console, Voice QoS Features
APOS & AP-VPMS Support

Performance

AP1000 Series VoIP Gateway Product Overview

APOS Internetworking Protocol Stack

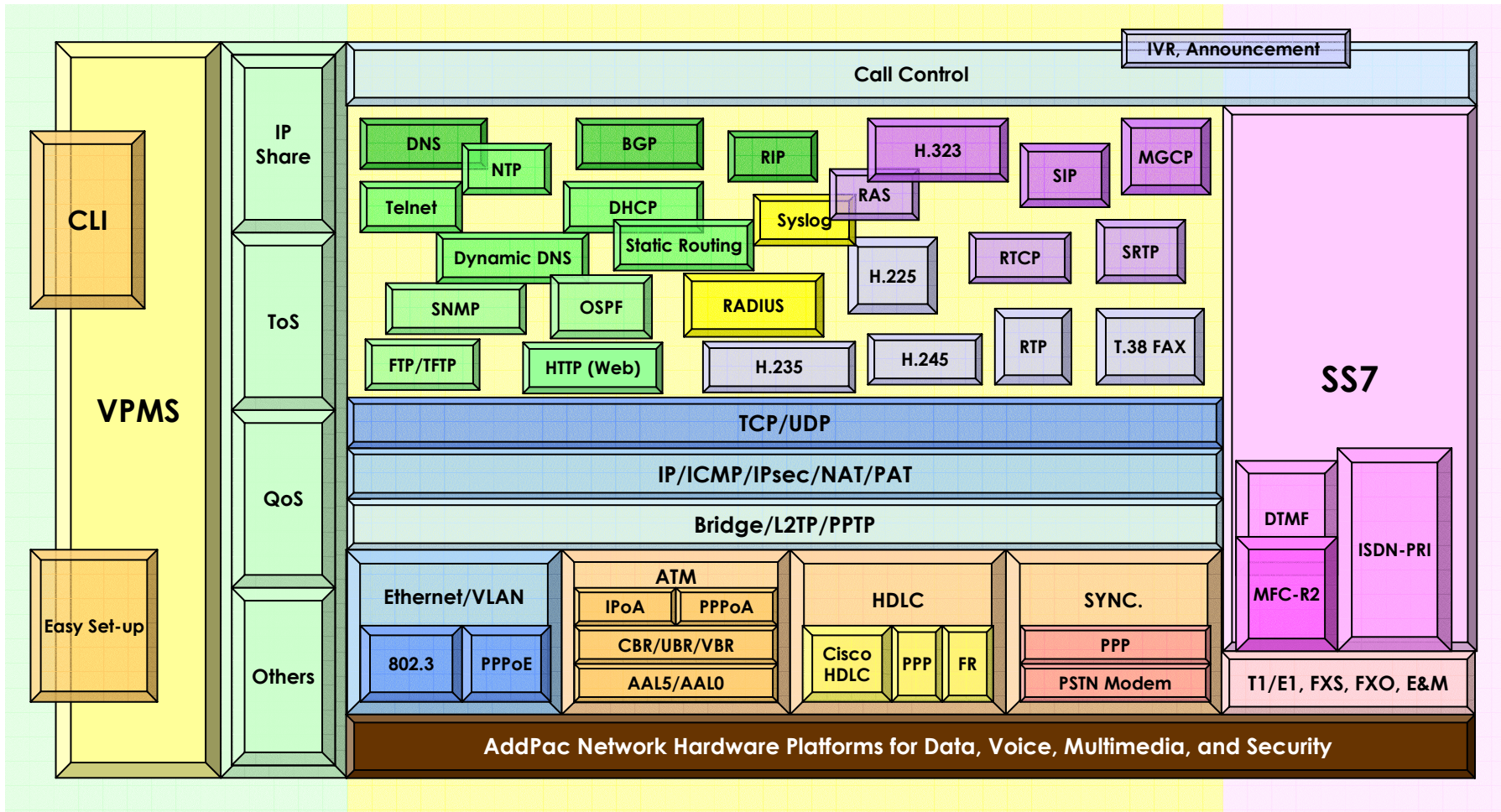

AP1000 Series VoIP Gateway Product Overview

APOS Internetworking S/W World

• APOS Internetworking Software World

- AddPac Operating System (APOS)
- Support Industry Standard
- Integrated Networking Protocols
- Optimized Performance & Functionality
- Easy to use, Installation, and Maintenance

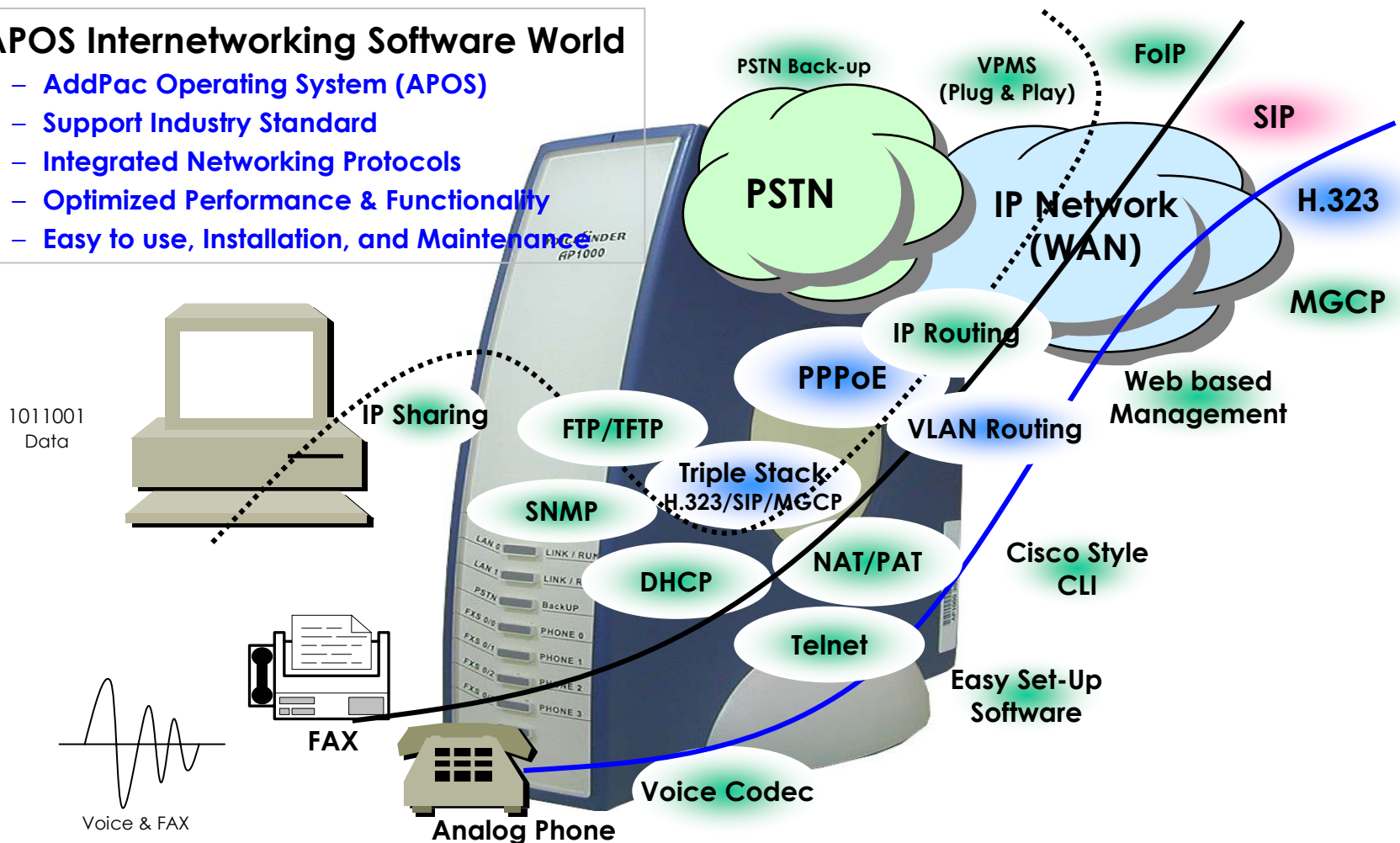

AP1000 Series VoIP Gateway Product Overview

APOS Internetworking S/W World (cont.)

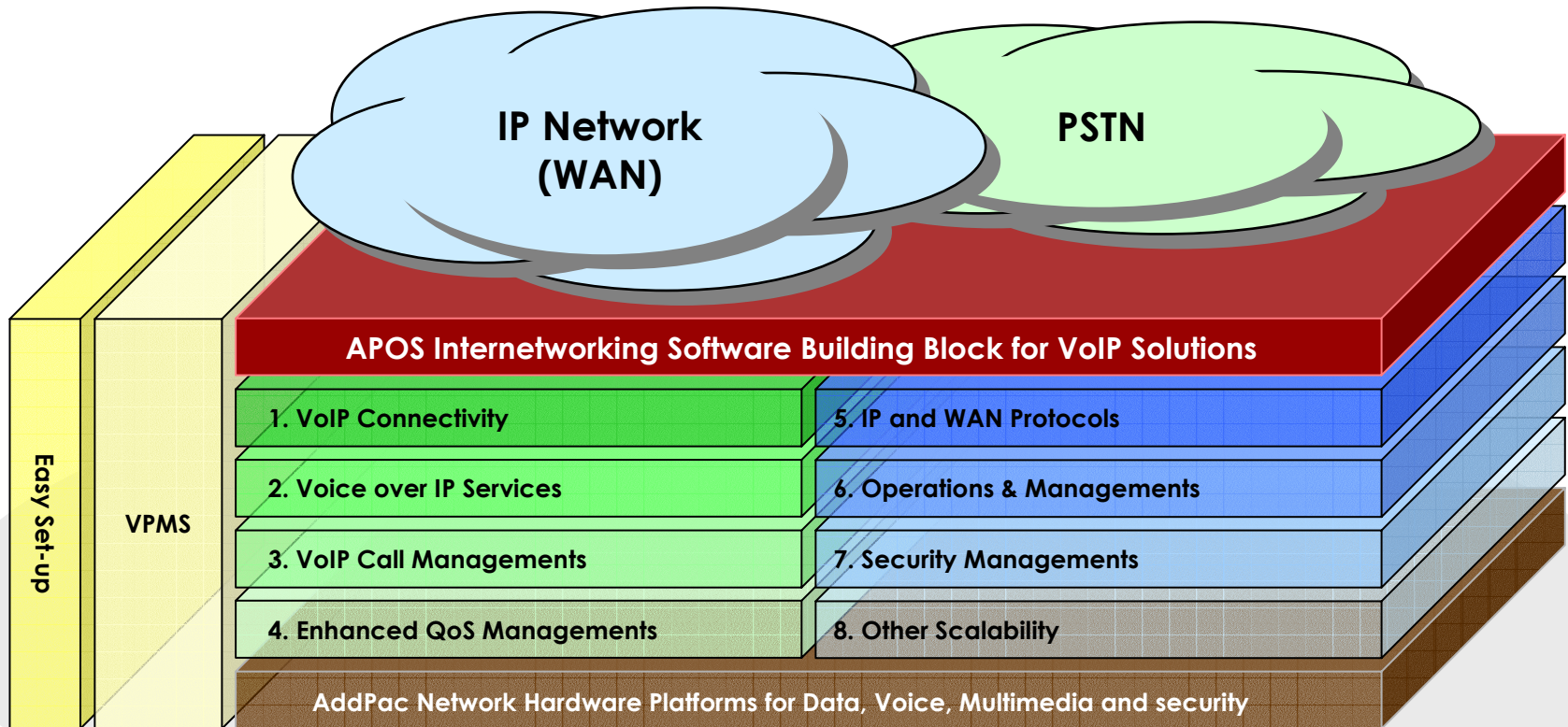

AP 1000 Series VoIP Gateway Product Overview

VoIP Gateway Connectivity

• FXS

- RJ-11 Hardware interface
- Polarity inverse generation function
- Caller-id generation function
- Busy-out function support
- Ring cadence setting function
- Ring frequency setting function
- European type II telephone support
- Surge protect support

• FXO

- RJ-11 Hardware interface
- Polarity inverse detection function
- Caller-ID detection function
- Busy-out function support
- PSTN backup or busy-out function with Hook off in case of power down
- Clear down tone registration and detect function
- Hook flash timing setting function
- Ring detect timeout setting function
- Ring number setting function
- For outbound calls, connect when voice is detected

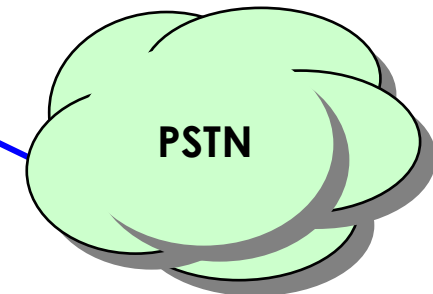
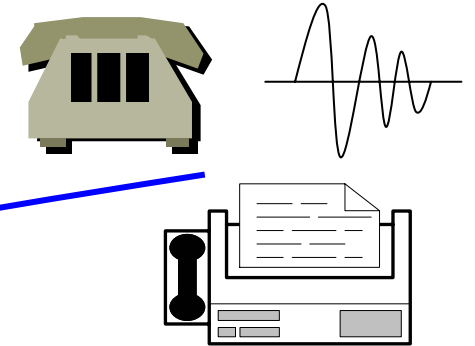
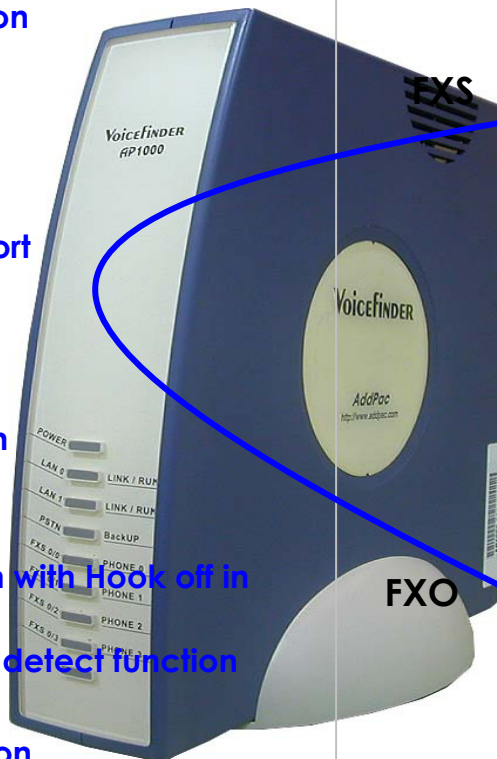

AP1000 Series VoIP Gateway Product Overview

Voice over IP Service

- **H.323, SIP, and MGCP Triple Stack**
 - Concurrent Triple VoIP Stack Software
 - Single Hardware with Three VoIP Service
 - New APOS-NX Version
- **H.323**
 - ITU-T Standard H.323 v3 Support
 - Support H.245 Tunneling
 - Including H.235 Security Features
- **SIP**
 - IETF RFC3261 or RFC2543 SIP Standard
- **MGCP**
 - IETF RFC2705bis-02 Standard MGCP 1.0

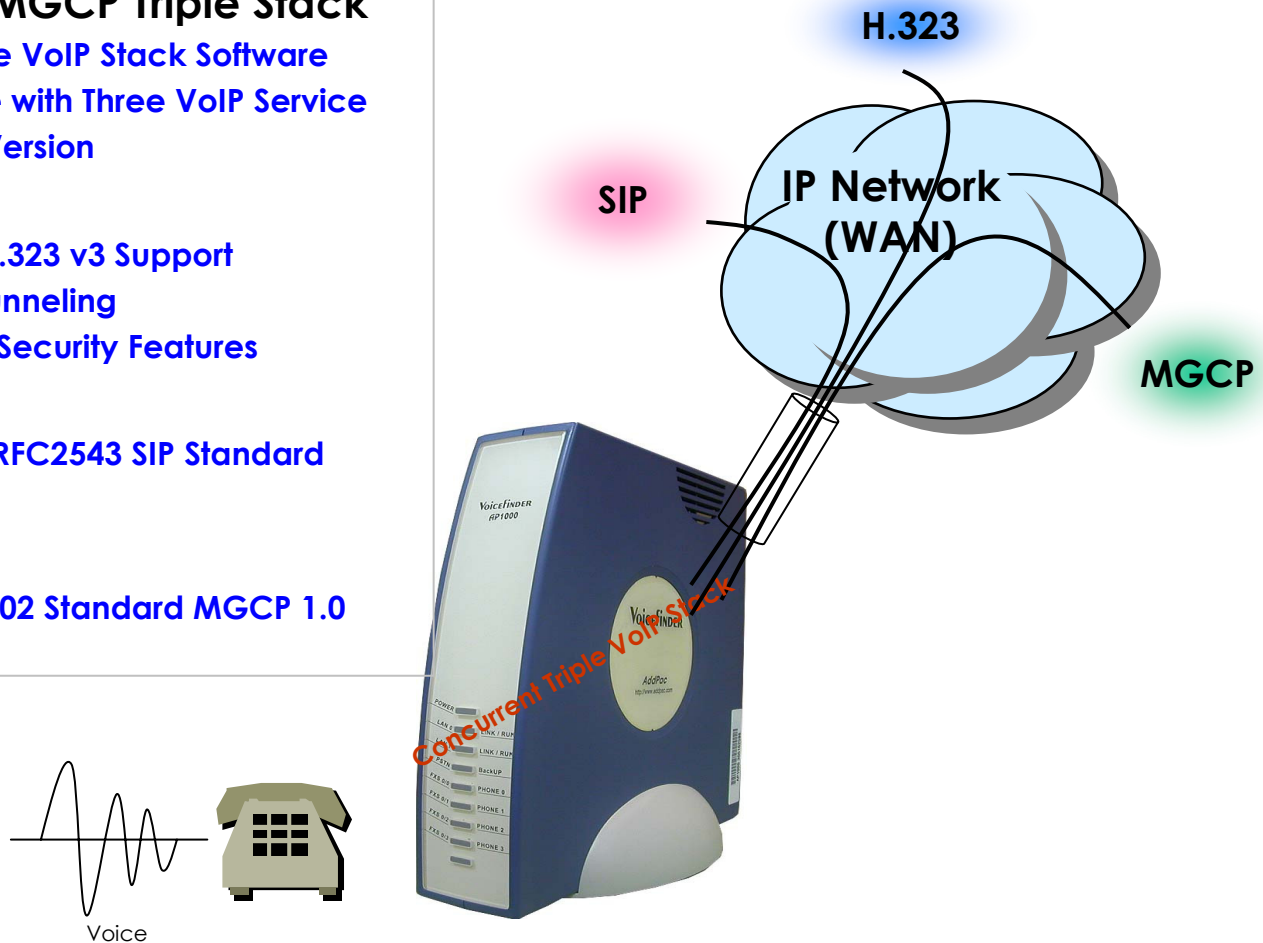

AP1000 Series VoIP Gateway Product Overview

Voice over IP Service (cont.)

• H.323

- Fast connect, normal connect support
- H.245 tunneling support
- Q.931 response message setting for inbound VoIP calls
- H.245 logical channel open timing selection function
- Start H.245 procedure support
- DTMF / Hook flash relay with H.245 alphanumeric / signal
- Secondary gatekeeper support
- Gatekeeper assignment according to the domain name
- Gatekeeper discovery with multicast
- Lightweight RRQ support
- Signaling TCP port assignment
- Resource threshold setting with RAI
- H.235 clear-token, crypto-token support
- canMapAlias support
- Technical prefix (supported prefix) support
- Public IP assignment in NAT environment



• SIP

- Gateway-based / Endpoint-based registration support
- Secondary proxy-server assignment function
- SIP signaling port change function
- SIP proxy server assignment according to the domain name
- T.38 real-time fax relay support
- DTMF relay support with RFC2833 / OPTION message
- Re-INVITE support

• MGCP

- Secondary call agent assignment function
- Default package assignment
- Announcement Server Package, Generic Media Package, Handset Package, Line Package, Trunk Package support
- MGCP call agent assignment according to the domain name
- T.38 real-time fax relay support
- DTMF relay support based on RFC2833

AP1000 Series VoIP Gateway Product Overview

Voice over IP Service (cont.)

• Voice Codec

- G.711 A-Law, G.711 U-Law
- G.726 r16, G.726 r32
- G.729A
- G.723.1 r63, G.723.1 r53
- VAD (Voice Activity Detection) function support
- DTMF relay support (H.323, SIP, MGCP common) based on RFC2833

• RTP

- Redundant RTP packet transmission in case of severe packet loss
- Dynamic jitter buffer management and RTP packet jitter and loss compensation with heuristic & DSP error concealment
- Static jitter buffer setting support
- Voice frame per RTP packet number control for each codec
- In-band ring-back tone support
- Virtual ring-back tone support
- Tone parameter change support

• FAX

- Fax relay mode supporting T.38, inband-T.38, bypass mode
- Lost packet compensation with redundant setting in case of T.38 fax relay
- Fax relay mode, rate setting for remote end

VoIP

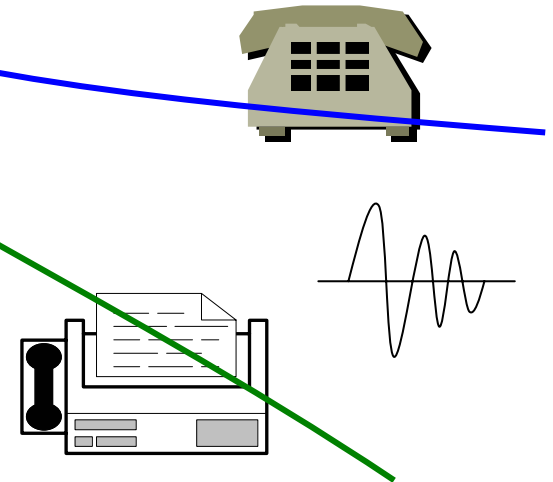
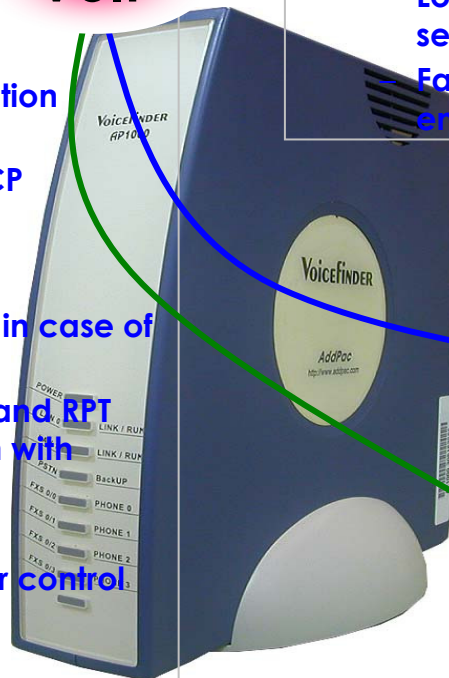

AP1000 Series VoIP Gateway Product Overview

VoIP Call Managements

• VoIP Call Controls

- Hot line connection function with PLAR (Private Line Auto Ring Down)
- Leased line emulation function
- Connection monitoring function
- Fault tolerant with Redundancy and Call Distribution among Gateways for load balancing
- Call attempt with IP address
- H.323, SIP, MGCP inbound call connection for each voice port
- Multiple E.164 setting for one voice port
- One E.164 or digit pattern can be assigned to more than one voice port
- Hunting with Longest match/ priority/ sequence/ random
- One stage call setup by Digit forwarding
- Call barring with specific digit patterns
- Calling and called number conversion for PSTN outbound calls
- PSTN rerouting in case of VoIP call attempt failure

• VoIP Call Controls (cont.)

- Call transfer for internal calls
- Call pickup for internal calls
- Calling and called number conversion for VoIP outbound calls
- Calling and called number conversion for VoIP inbound calls
- Fax broadcasting call control

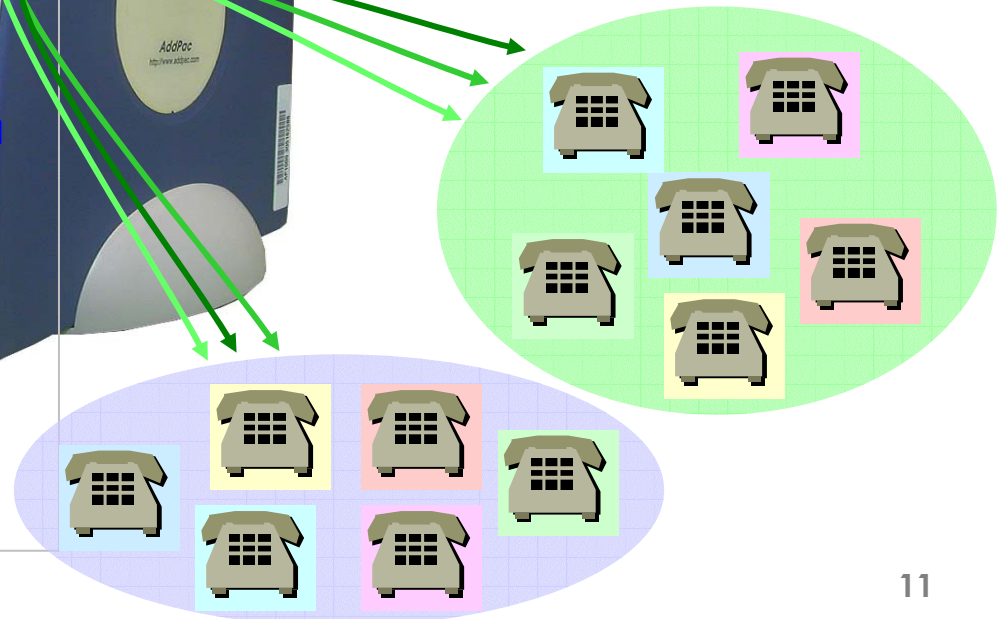

AP1000 Series VoIP Gateway Product Overview

Enhances QoS Managements

- Enhances **Transmit** Voice QoS Features

- Voice Traffic Priority Queuing
- QoS Service Profiling
- Providing Virtual Network Transmit Algorithm
- Real-time Voice Traffic QoS Support
- RTP Packet Transmit Interval Control
- Supporting RTP Packet Redundancy Scheme
- IP Header Control such as ToS, Diffserv

- Enhances **Receive** Voice QoS Features

- Dynamic Jitter Buffer Management
- Error Concealment
- Support T.38 FAX Data Error Recovery Scheme

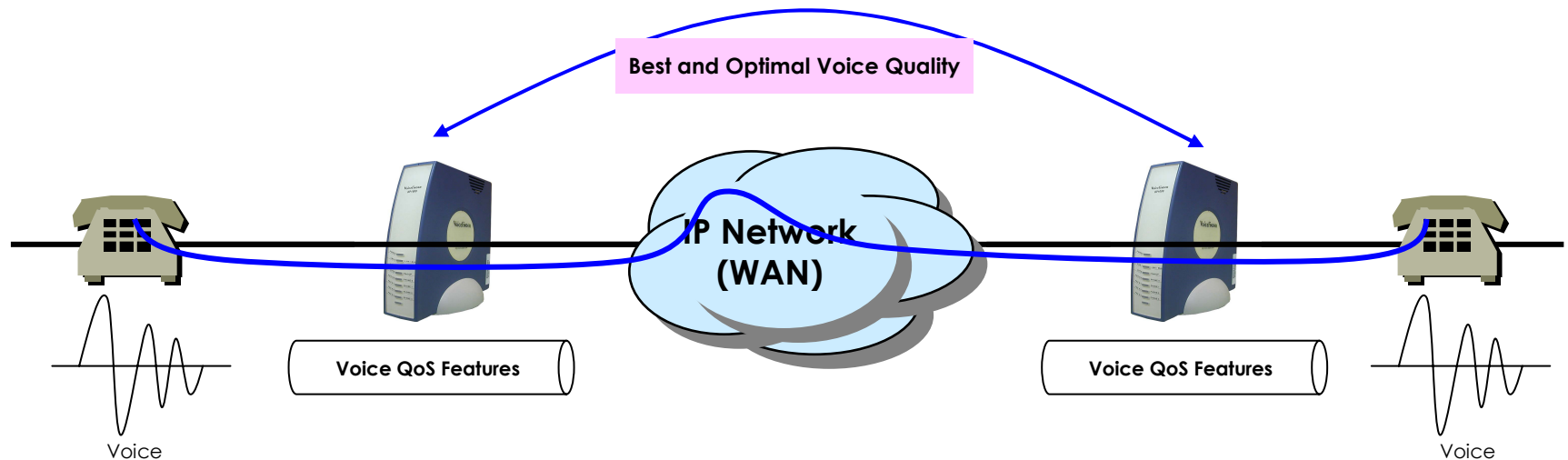

AP1000 Series VoIP Gateway Product Overview

Enhances QoS Managements (cont.)

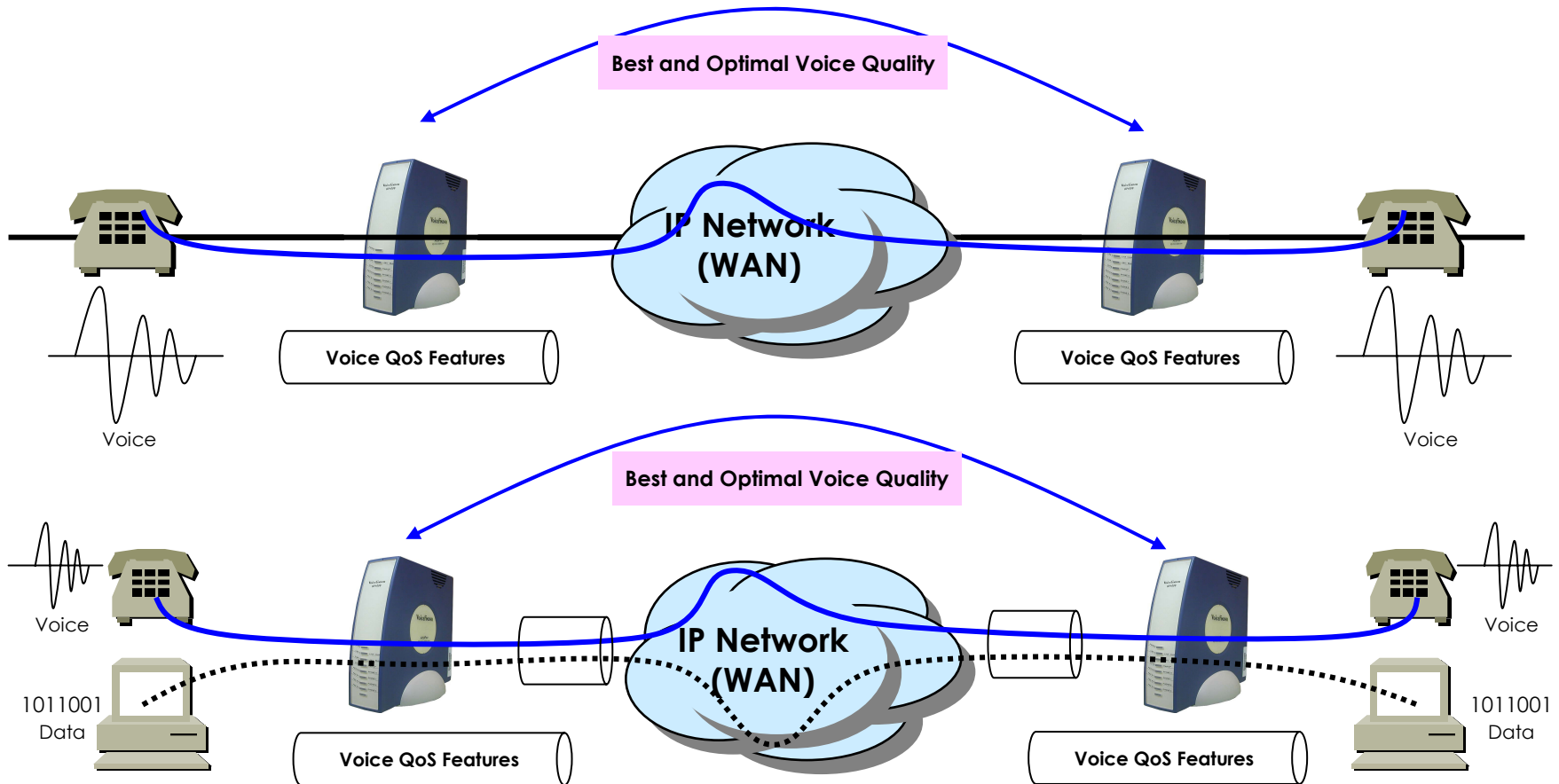

AP1000 Series VoIP Gateway Product Overview

Enhances QoS Managements (cont.)

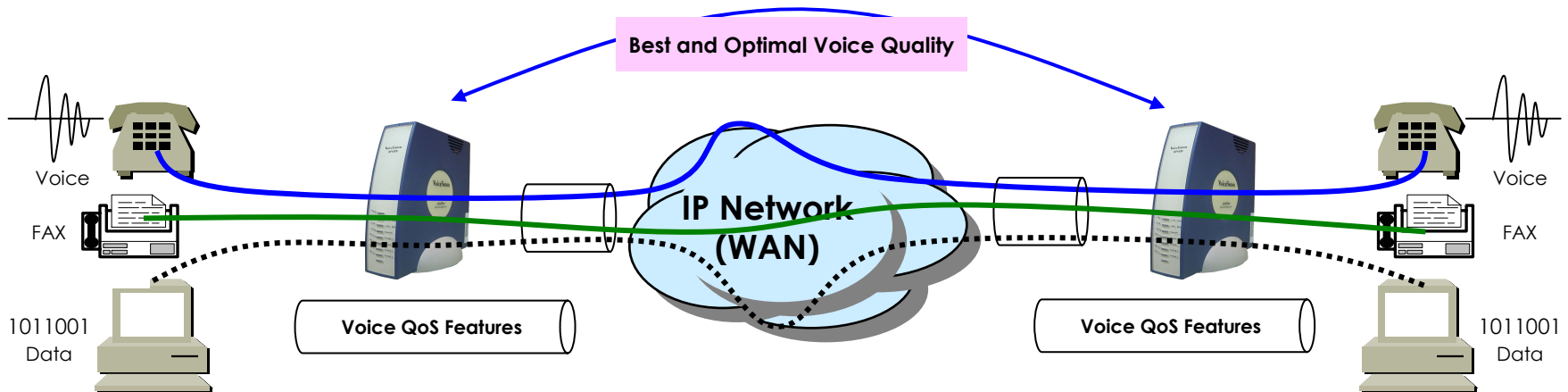
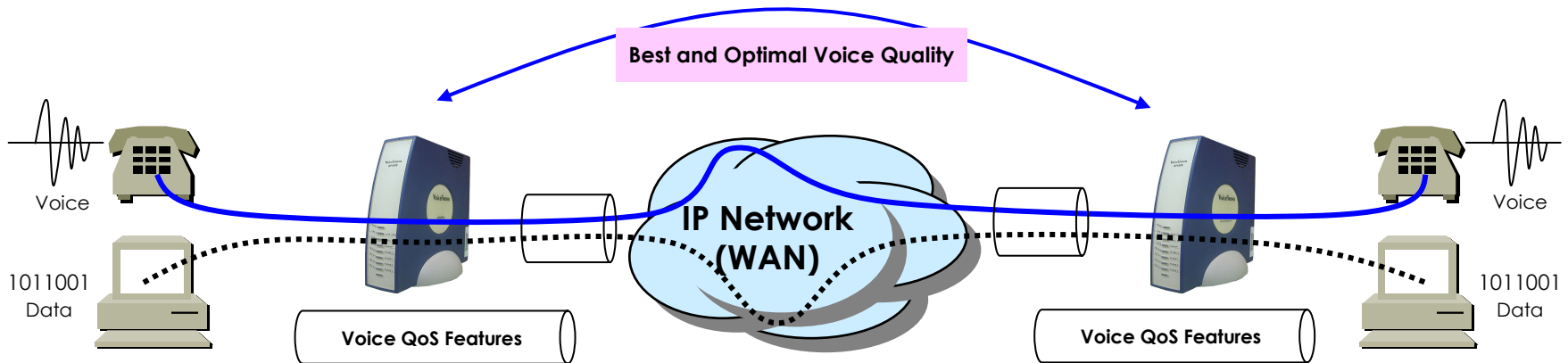

AP1000 Series VoIP Gateway Product Overview

Enhances QoS Managements (cont.)

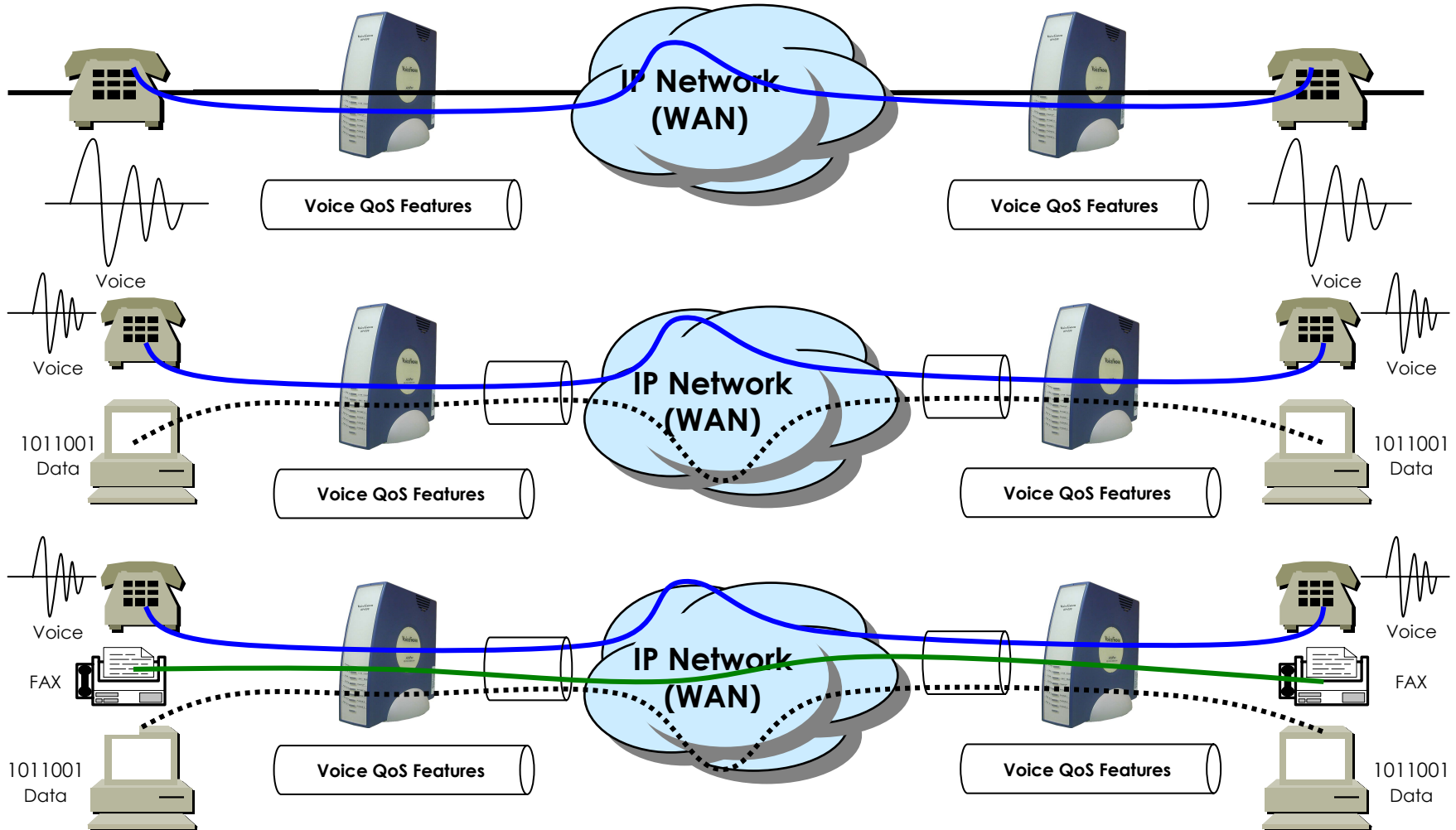

AP1000 Series VoIP Gateway Product Overview

IP and WAN Protocols

- **IP Routing Protocols**

- Multi-protocol Internetworking Services
- Static IP routing
- RIP v1/v2 (opt.)
- OSPF v2 routing protocols support (opt.)
- Transparent Bridging (IEEE Spanning Tree Protocol)

- **WAN Protocols**

- Point-to-Point Protocol (PPP)
- High-level Data Link Control (HDLC) Protocol

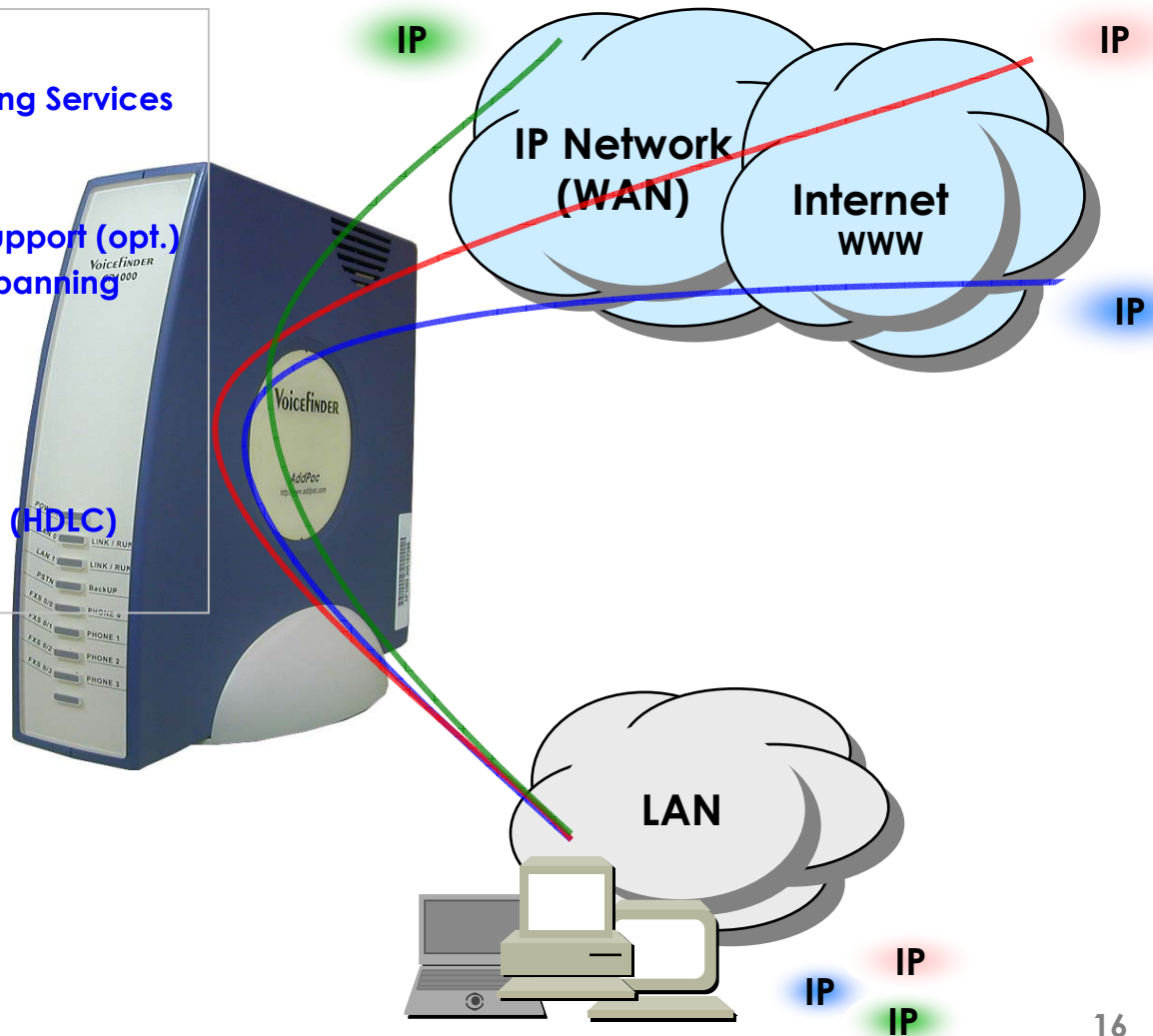

AP1000 Series VoIP Gateway Product Overview

Network Managements

- **SNMP**

- Standard Simple Network Management Protocol(SNMP) Agent support
- MIB v1 and v2 Support

- **Web-based Management**

- Standard Voice Interface
- Standard PSTN Back-up Interface

- **Watch-dog Function**

- Hardware, Software watch-dog services

- **Remote Management**

- Telnet
- Rlogin
- Console

- **Auto Upgrade Service**

- HTTP server based APOS image and configuration file auto-upgrade support

- **Batch Job Function**

- Text based script downloading

- **Easy Set-up Service**

- MS Windows Graphical User Interface (GUI) based installation Software Solution
- Easy installation Set-up service

- **Interoperable with AP-VPMS Service**

- AddPac VoIP Plug & Play Management System (AP-VPMS)

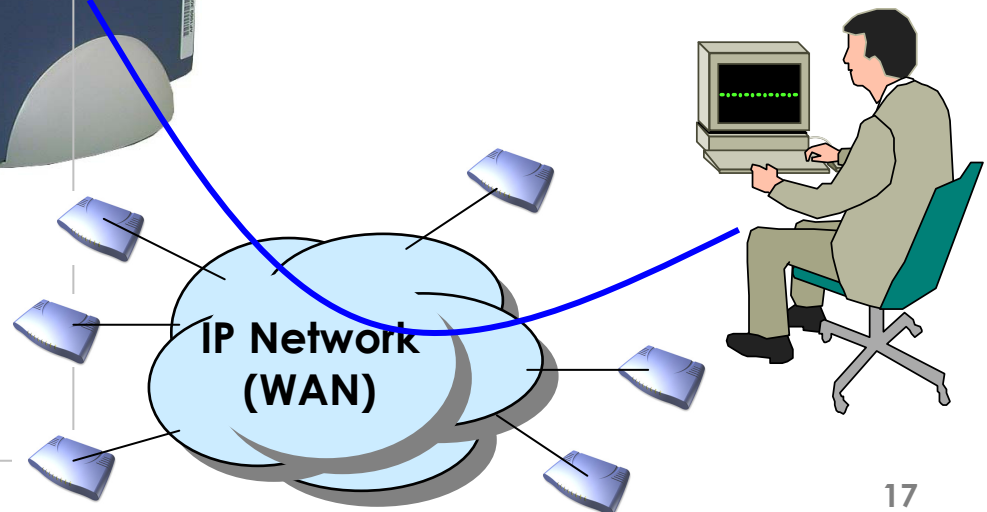

AP1000 Series VoIP Gateway Product Overview

Security Managements

- IP packet filtering
- IP access list
- User authentication function
 - Password Authentication Protocol (PAP)
 - Challenge Handshake Authentication Protocol (CHAP)
- Enable/Disable specific protocols
- Auto-square connect of console and Telnet session
- Account Management function for multi-level user
- SNMP/TELNET/FTP/HTTP/TFTP port assignment function
- SNMP/TELNET/FTP access list management
- Boot mode security checking function

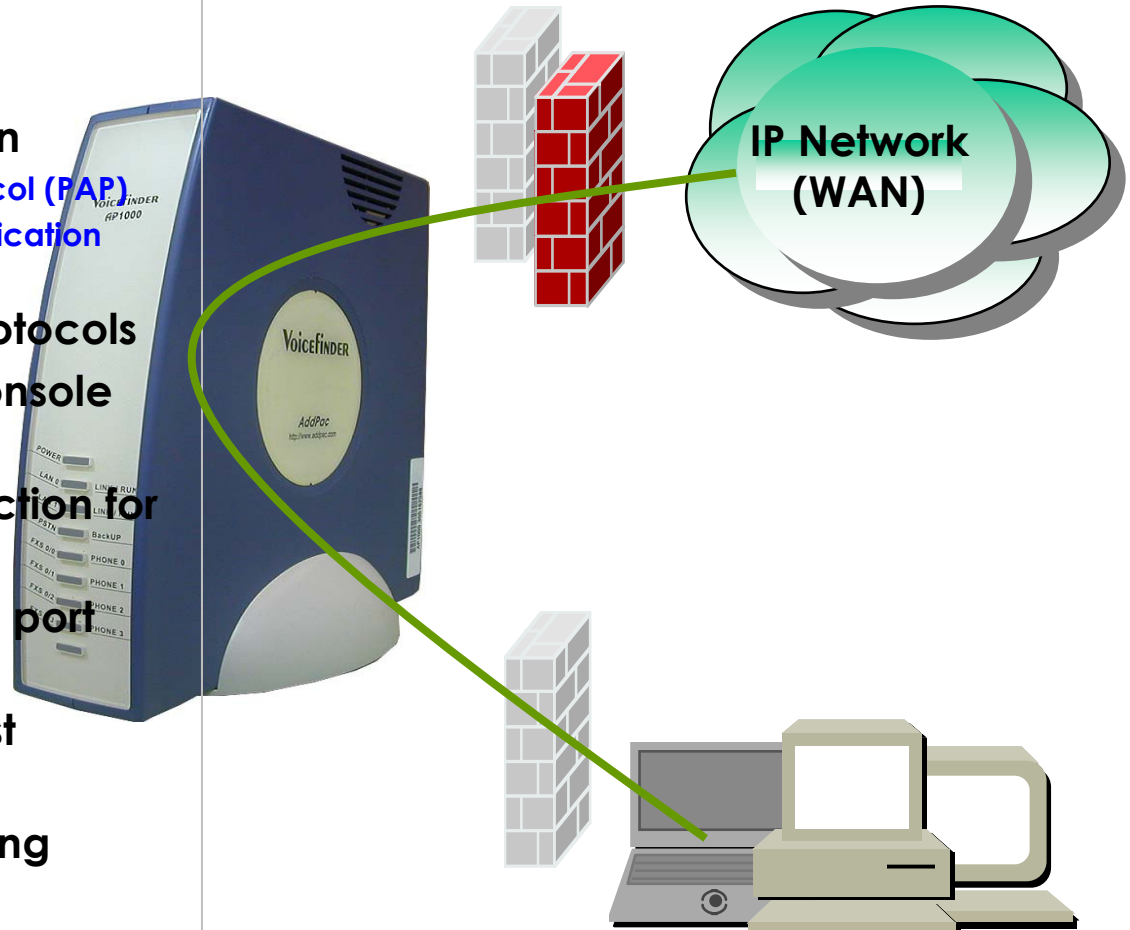

AP1000 Series VoIP Gateway Product Overview

Network Scalability

- **IP Sharing Feature**
 - Single IP Address, Multiple IP Network Access
 - Public IP Address Sharing by VoIP Gateway
- **IP Sharing Network Environment**
 - Support Legacy Network Environment
 - xDSL Modem based Broadband Network
 - Cable Modem based Broadband Network
 - Leased line Network Environment
- Both support Fixed and Dynamic IP
- Support Standard Network Protocols
 - PPPoE
 - PPPTP
 - DHCP



AP1000 VoIP Gateway Series

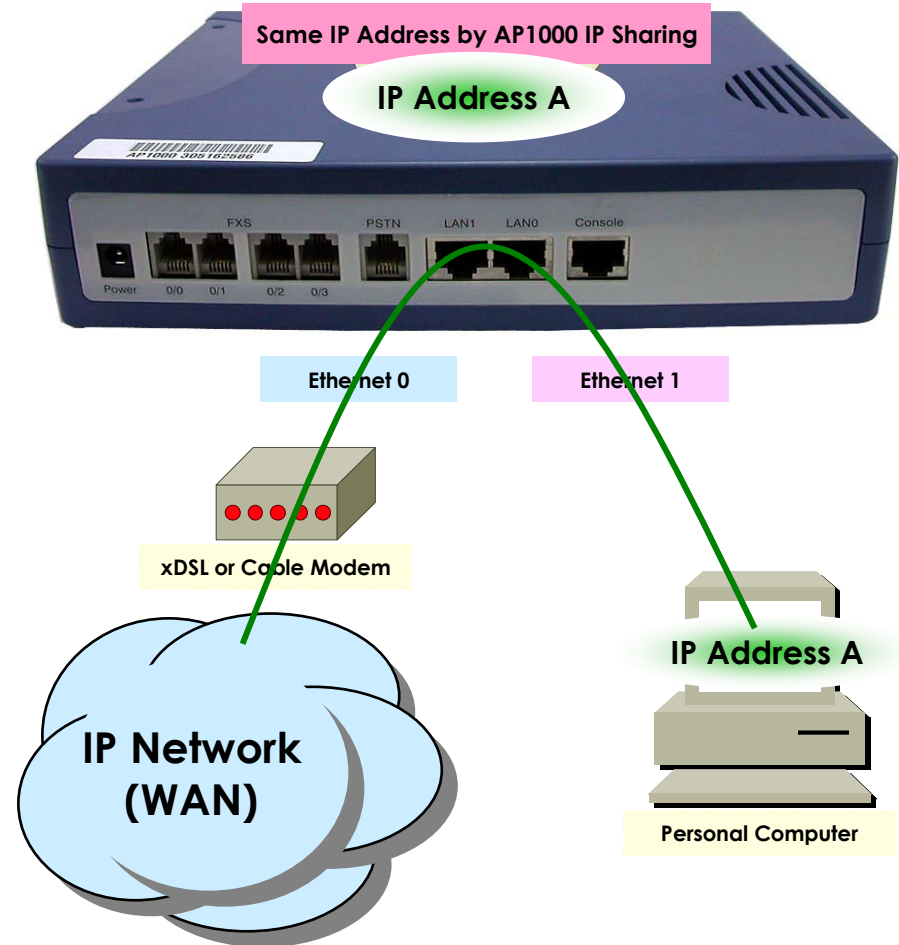

AP1000 Series VoIP Gateway Product Overview

Network Scalability (cont.)

- **Bridging Service**
 - Spanning Tree Bridging protocol (IEEE) support
- **DHCP**
 - Server and Relay
- **IP Accounting**
- **PAT (Port Address Translation)**
- **NAT (Network Address Translation)**
- **Cisco Style CLI (Command Line Interface)**
- **PPTP (Point-to-Point Tunneling Protocol)**
- **NTP (Network Time Protocol)**
- **FTP/TFTP**
 - Server and Client support
- **DNS**
 - Dynamic DNS Client support

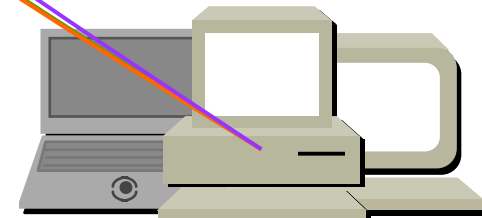
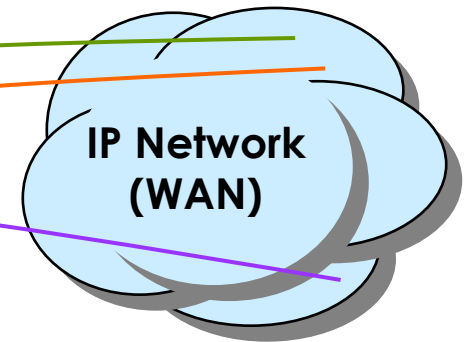
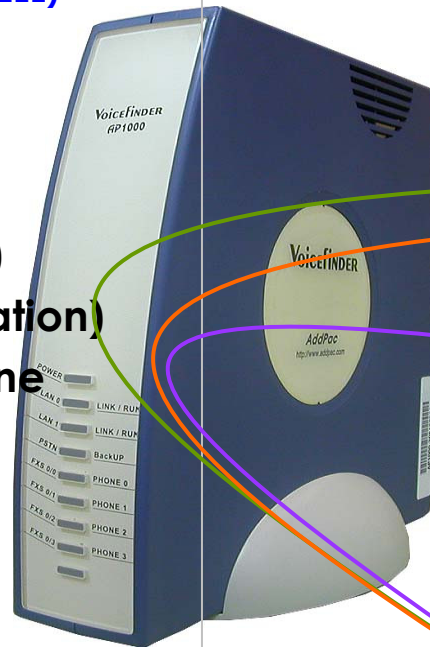

AP1000 Series VoIP Gateway Product Overview

VoIP Plug & Play System (VPMS)

- **AddPac AP-VPMS Support**
 - AddPac VoIP Plug & Play System (VPMS)
 - Best EMS Solutions for AddPac VoIP G/W
- **Requirements Hardware Platform**
 - Over 1GHz Intel Pentium 4 Machine
 - Over 1GB Main Memory
 - Over 40GB Hard Disk Memory
 - Microsoft Windows Advanced Server or Windows 2000 Server or Windows XP Professional
 - DBMS : Microsoft MS-SQL Server 2000

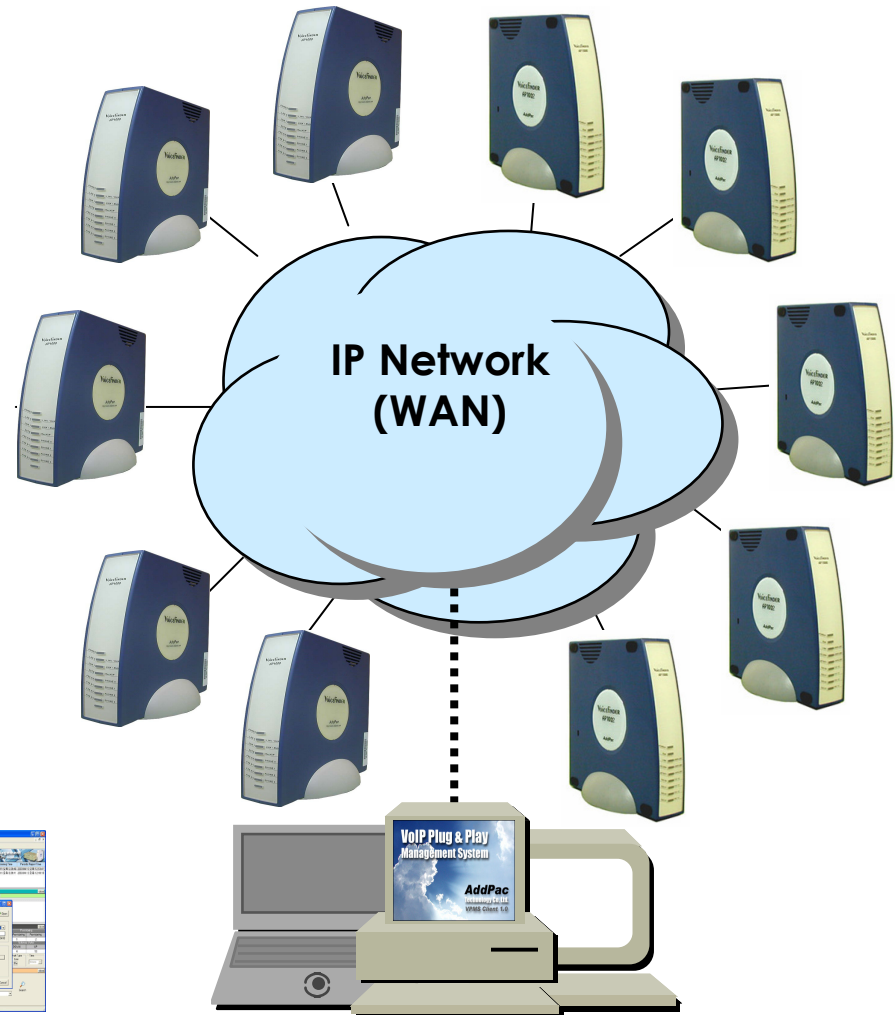

AP1000 Series VoIP Gateway Product Overview

Network Configurations

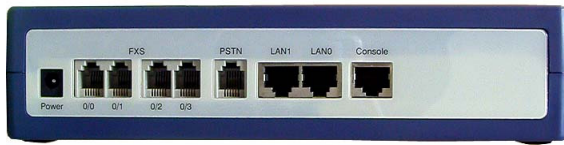

- Front View Side of AP1000 Series
- AP1000
 - 4-Port FXS Voice Interface
 - 1-Port Console
 - 2 -Port 10Mbps Ethernet
 - 1 -Port PSTN Back-up
- AP1002
 - 2-Ports FXS & 2 Ports FXO Voice Interface
 - , 1-Port Console
 - 2 -Port 10Mbps Ethernet
- AP1005
 - 4-Port FXO Voice Interface
 - 1-Port Console
 - 2 -Port 10Mbps Ethernet
- AddPac AP-VPMS Support
 - AddPac VoIP Plug & Play System (VPMS)
 - Best EMS Solutions for AddPac VoIP G/W

AP1000VoIP Gateway Product Overview

Hardware Specification

Hardware Specifications

AP1000 VoIP Series	Basic Specifications
CPU	32Bit RISC Microprocessor
Voice Interface	4-Ports FXS Voice Interface(RJ-11)
Ethernet Interface	2-Ports 10Mbps Ethernet Interface(RJ-45)
Console Port	1-Port RS-232C Console Port(RJ-45)
PSTN Backup Port	1-Port PSTN Backup Port(RJ-11/Only AP1000)
Flash Memory	2 Mbyte High-speed Flash Memory
Main Memory	32 Mbyte High-speed SDRAM
Boot Memory	512Kbyte Flash Memory
Power Requirement	External Power Supply Adaptor / VAC 110~220V, 5V 2A 10Watt
Operating Temperature	0°C ~ 50°C (32 °F ~ 122°F)
Storage Temperature	-40°C ~ + 85°C (-40°C ~ 185°F)
Relative Humidity	5% ~ 95% (Non-condensing)
Dimensions	50mm x 210mm x 210mm (H x W x D)
Weight (g)	400g

Network interface Configurations

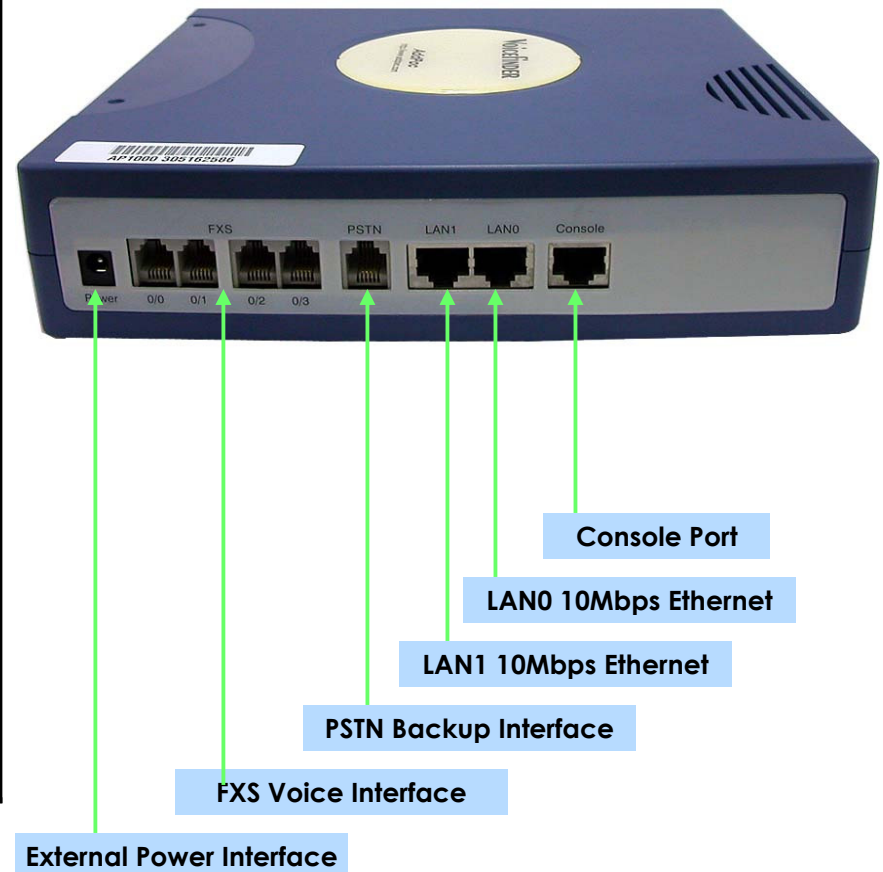

AP1002 VoIP Gateway Product Overview

Hardware Specification

Hardware Specifications

AP1000 VoIP Series	Basic Specifications
CPU	32Bit RISC Microprocessor
Voice Interface	2FXS & 2 FXO Voice Interface(RJ-11)
Ethernet Interface	2-Ports 10Mbps Ethernet Interface(RJ-45)
Console Port	1-Port RS-232C Console Port(RJ-45)
Flash Memory	2 Mbyte High-speed Flash Memory
Main Memory	32 Mbyte High-speed SDRAM
Boot Memory	512Kbyte Flash Memory
Power Requirement	External Power Supply Adaptor / VAC 110~220V, 5V 2A 10Watt
Operating Temperature	0°C ~ 50°C (32 °F ~ 122°F)
Storage Temperature	-40°C ~ + 85°C (-40°C ~ 185°F)
Relative Humidity	5% ~ 95% (Non-condensing)
Dimensions	50mm x 210mm x 210mm (H x W x D)
Weight (g)	400g

Network interface Configurations

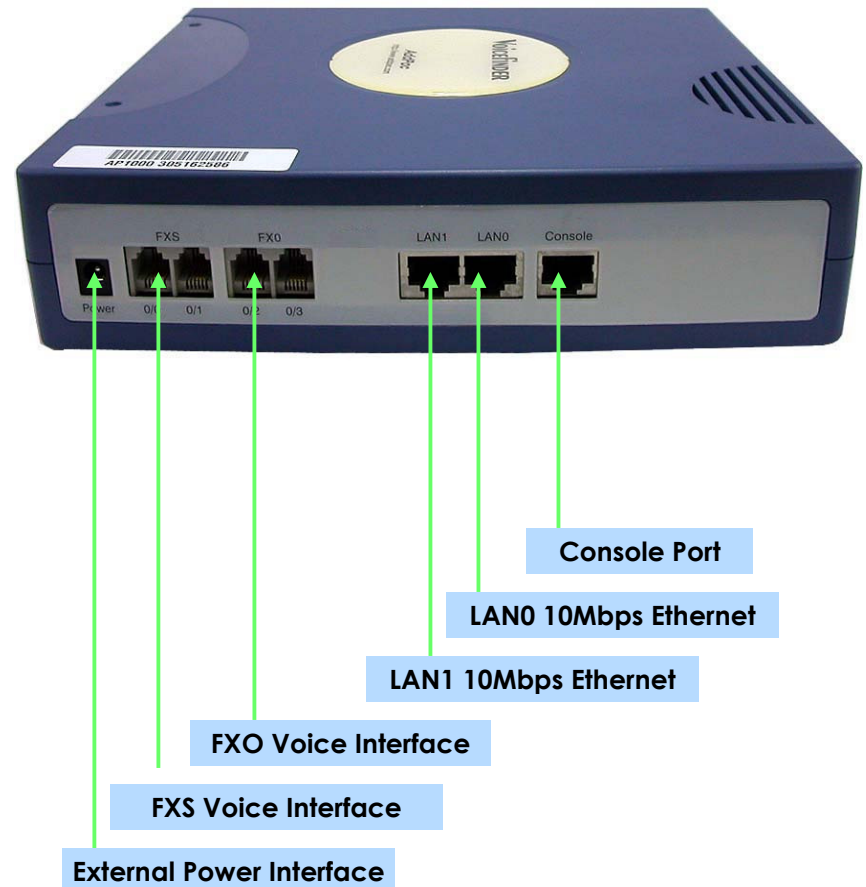

AP1005 VoIP Gateway Product Overview

Hardware Specification

Hardware Specifications

AP1000 VoIP Series	Basic Specifications
CPU	32Bit RISC Microprocessor
Voice Interface	4-Ports FXO2Voice Interface(RJ-11)
Ethernet Interface	2-Ports 10Mbps Ethernet Interface(RJ-45)
Console Port	1-Port RS-232C Console Port(RJ-45)
Flash Memory	2 Mbyte High-speed Flash Memory
Main Memory	32 Mbyte High-speed SDRAM
Boot Memory	512Kbyte Flash Memory
Power Requirement	External Power Supply Adaptor / VAC 110~220V, 5V 2A 10Watt
Operating Temperature	0°C ~ 50°C (32 °F ~ 122°F)
Storage Temperature	-40°C ~ + 85°C (-40°C ~ 185°F)
Relative Humidity	5% ~ 95% (Non-condensing)
Dimensions	50mm x 210mm x 210mm (H x W x D)
Weight (g)	400g

Network interface Configurations

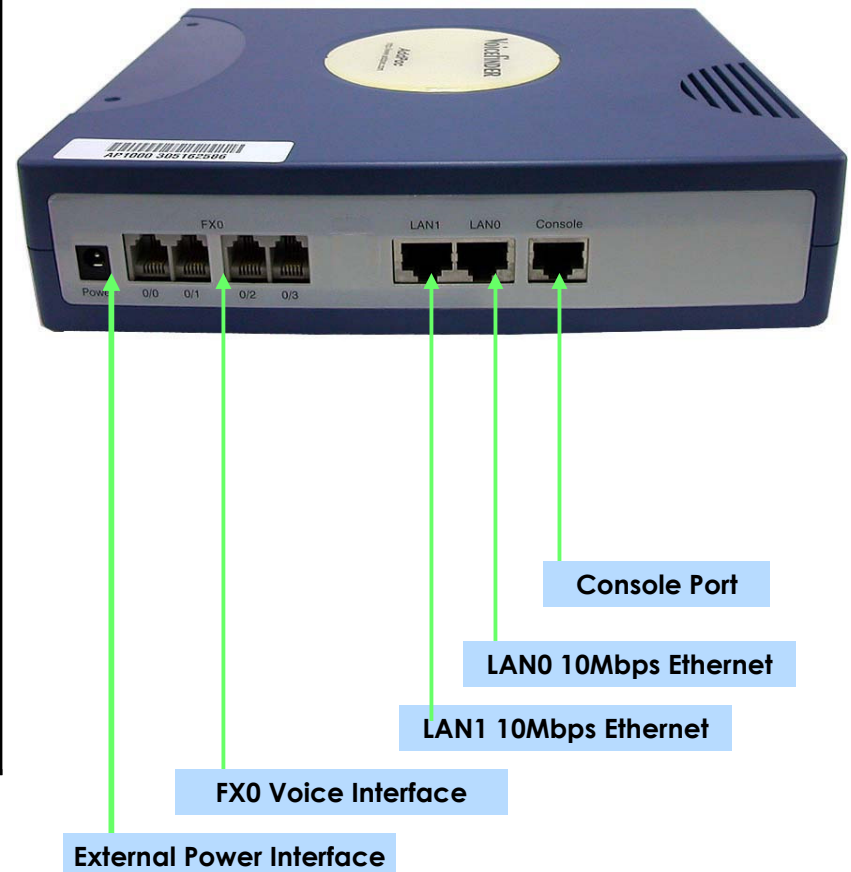

AP1000 Series VoIP Gateway Product Overview

Networking Interface

- **High-performance Hardware**

- 32bit RISC Microprocessor Architecture
- High-performance DSP Architecture
- High-speed Memory with Boot Loader
- Dual Ethernet Interface for WAN & LAN
- Standard FXS and FXO Voice Interface
- Standard PSTN Back-up Interface
- RS-232C Console Interface

- **Compact Design**

- Small, Light, and Compact Design

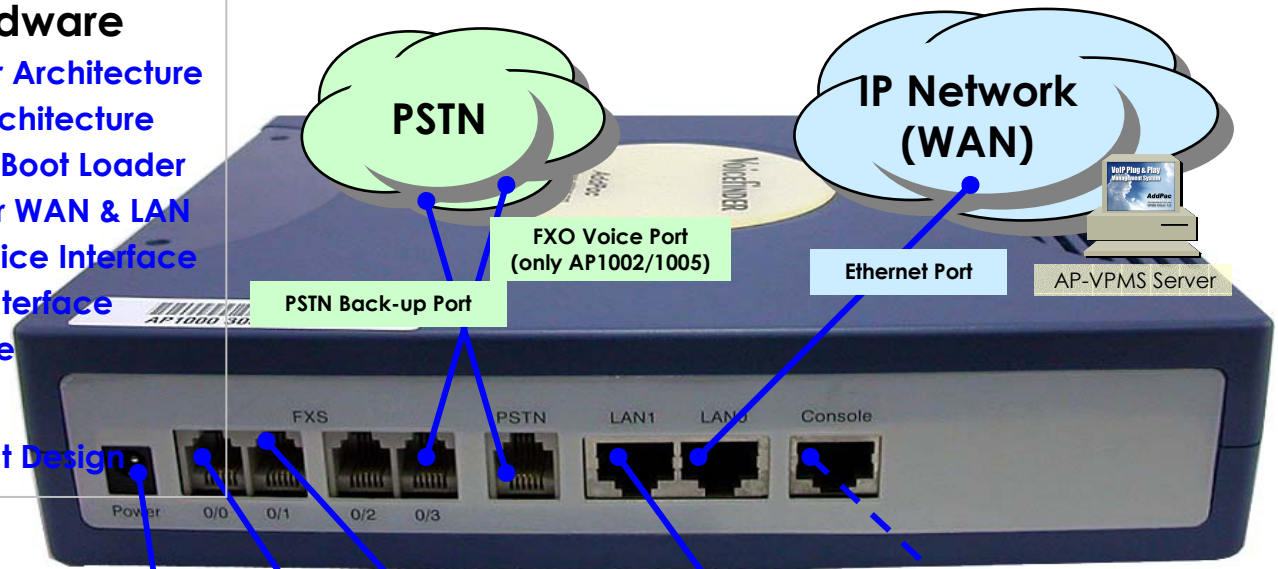

AP1000 VoIP Gateway Series



Ext. Power Supply



Analog Phone

FAX

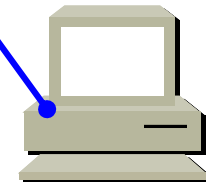

LAN Port



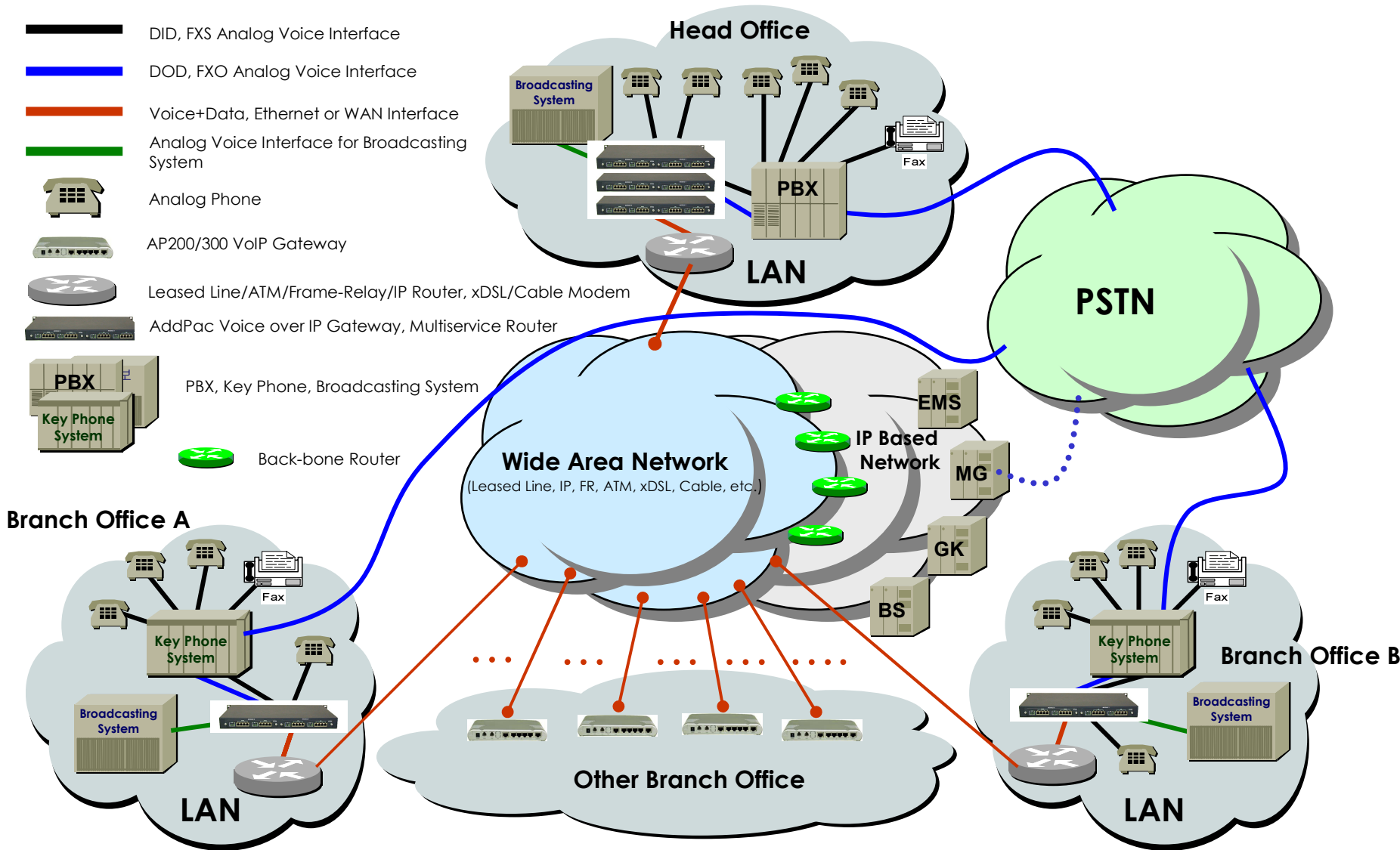

RS-232C Console

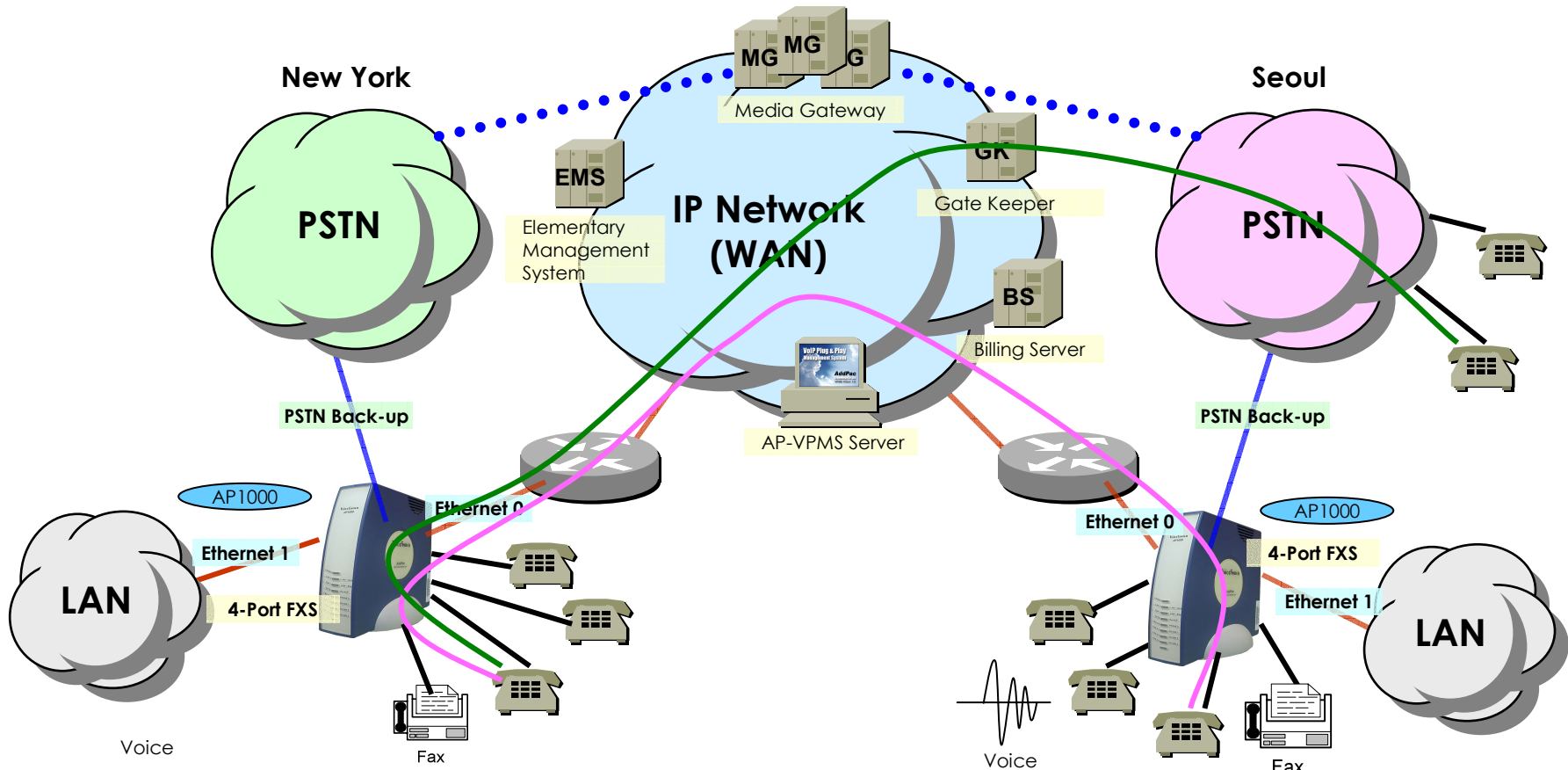

AddPac VoIP Gateway Network Diagram Example



AP1000 Voice Networking Configuration







-  FXS Analog Voice Interface
-  FXO Analog Voice Interface
-  Voice+Data, Ethernet or WAN Interface
-  TRUNK n x E1 Voice Interface for PSTN Interworking

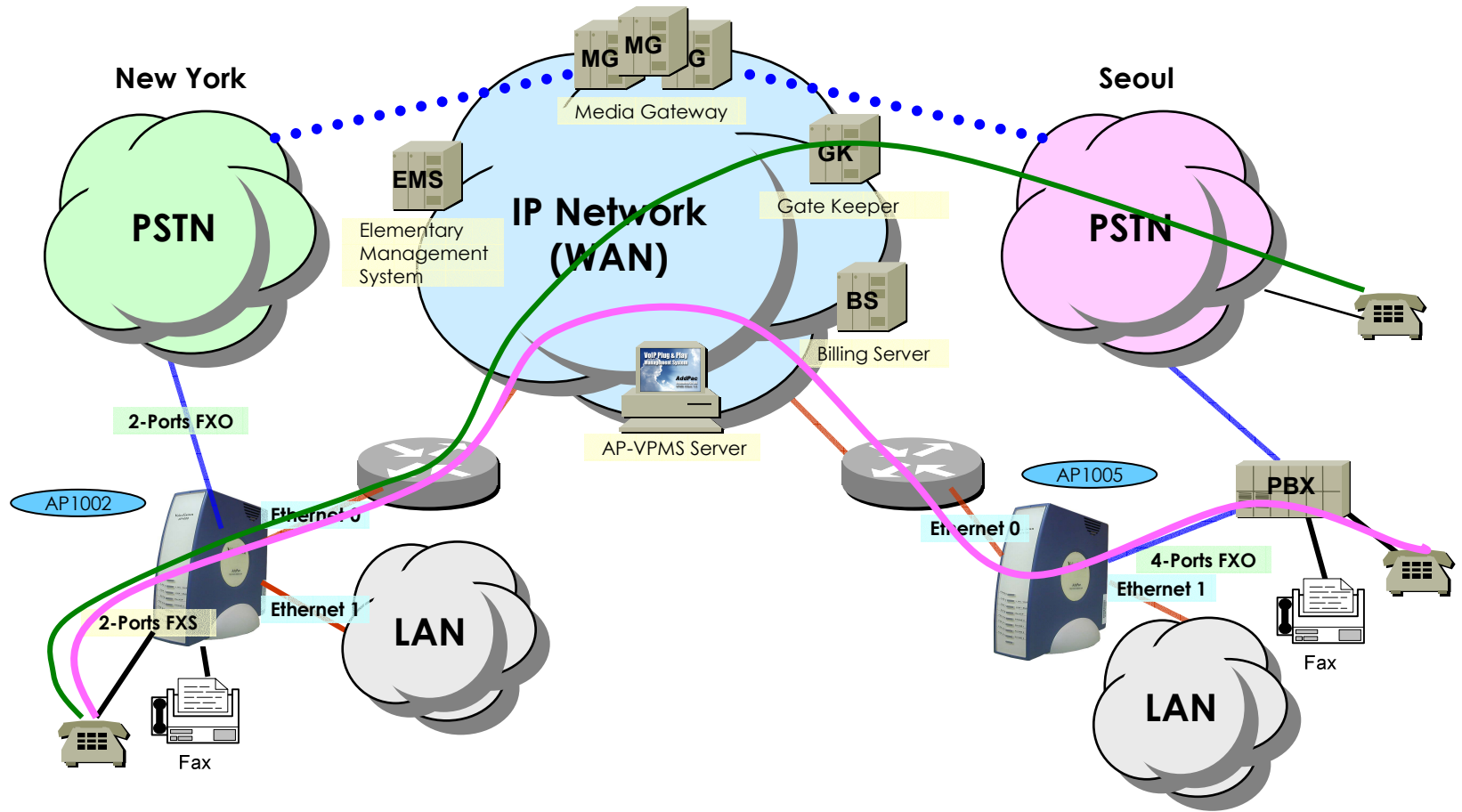

-  Leased Line/ATM/Frame-Relay/IP Router, xDSL/Cable Modem, etc.
-  AddPac AP1000 Voice over IP Gateway
-  Analog Phone

AP1002 & 1005 Voice Networking Configuration



-  FXS Analog Voice Interface
-  FXO Analog Voice Interface
-  Voice+Data, Ethernet or WAN Interface
-  TRUNK n x E1 Voice Interface for PSTN Interworking



-  Leased Line/ATM/Frame-Relay/IP Router, xDSL/Cable Modem, etc.
-  AddPac AP1002/1005 Voice over IP Gateway Series
-  Analog Phone

AP1000 Series VoIP Gateway Product Overview

Ordering and Pricing

• AP1000 Series VoIP Gateway Pricing & Ordering

- AddPac Technology Regional Sales Managers
- Authorized Sales and Marketing Representatives
- Please Contact www.addpac.com

Model	Product Description	Available	Remarks
AP1000	Fixed 4-Ports FXS Voice Interface, 2-Ports 10Mbps Ethernet, 1-Port PSTN Back-up Interface, 1-Port Console, APOS Software with Voice Traffic QoS	Now	
AP1002	2-Ports FXS and 2-Ports FXO Voice Interface, 2-Ports 10Mbps Ethernet, 1-Port Console, APOS Software with Voice Traffic QoS	Now	
AP1005	4-Ports FXO Voice Interface, 2-Ports 10Mbps Ethernet, 1-Port Console, APOS Software with Voice Traffic QoS	Now	

AP1000 Series VoIP Gateway Product Overview

Comparison Table

	AP1000 VoIP Gateway Series		
	AP1000	AP1002	AP1005
▶ FXS Voice Ports (RJ11)	4	2	-
▶ FXO Voice Port (RJ11)	-	2	4
▶ PSTN Backup Voice Port (RJ11)	1	-	-
▶ 10Mbps Ethernet Ports (RJ45)	2	2	2
▶ Console Ports (RJ45)	1	1	1
▶ CPU	32Bit RISC	32Bit RISC	32Bit RISC
▶ Flash Memory	2Mbyte	2Mbyte	2Mbyte
▶ Main Memory (SDRAM)	32Mbyte	32Mbyte	32Mbyte
▶ Power Supply	Ext. PSU	Ext. PSU	Ext. PSU
▶ Internetworking OS	APOS	APOS	APOS
▶ H.323, SIP VoIP Protocol, T38 FAX, MGCP	YES	YES	YES
▶ PPPoE, PPTP Network Protocols	YES	YES	YES
▶ Enhanced QoS Management Feature	YES	YES	YES
▶ IP Routing Protocols Including NAT	YES	YES	YES
▶ Network Management Protocols	YES	YES	YES
▶ Support Network Environments	ADSL, VDSL, Cable Modem, Leased Line, ATM, Frame-Relay, Including Conventional Broad Band Networking		

Thank you !

www.addpac.com

Steven Lee

Assistant General Manager of Sales & Marketing

steven@addpac.com

Phone : +82 2 568 3848

Mobile Phone : +82 11 9951 8043

Fax : +82 2 568 3847